



Allen-Bradley

ControlLogix Controllers

**1756-L55M12, 1756-L55M13,
1756-L55M14, 1756-L55M16,
1756-L55M22, 1756-L55M23,
1756-L55M24, 1756-L61, 1756-L62,
1756-L63, 1756-L64,
1756-L60M03SE**

Firmware Revision 16

User Manual

**Rockwell
Automation**

Important User Information

Solid state equipment has operational characteristics differing from those of electromechanical equipment. Safety Guidelines for the Application, Installation and Maintenance of Solid State Controls (Publication SGI-1.1 available from your local Rockwell Automation sales office or online at <http://literature.rockwellautomation.com>) describes some important differences between solid state equipment and hard-wired electromechanical devices. Because of this difference, and also because of the wide variety of uses for solid state equipment, all persons responsible for applying this equipment must satisfy themselves that each intended application of this equipment is acceptable.





In no event will Rockwell Automation, Inc. be responsible or liable for indirect or consequential damages resulting from the use or application of this equipment.

The examples and diagrams in this manual are included solely for illustrative purposes. Because of the many variables and requirements associated with any particular installation, Rockwell Automation, Inc. cannot assume responsibility or liability for actual use based on the examples and diagrams.

No patent liability is assumed by Rockwell Automation, Inc. with respect to use of information, circuits, equipment, or software described in this manual.

Reproduction of the contents of this manual, in whole or in part, without written permission of Rockwell Automation, Inc. is prohibited.

Throughout this manual we use notes to make you aware of safety considerations.

WARNING 	Identifies information about practices or circumstances that can cause an explosion in a hazardous environment, which may lead to personal injury or death, property damage, or economic loss.
IMPORTANT	Identifies information that is critical for successful application and understanding of the product.
ATTENTION 	Identifies information about practices or circumstances that can lead to personal injury or death, property damage, or economic loss. Attentions help you identify a hazard, avoid a hazard, and recognize the consequence
SHOCK HAZARD 	Labels may be on or inside the equipment, for example, a drive or motor, to alert people that dangerous voltage may be present.
BURN HAZARD 	Labels may be on or inside the equipment, for example, a drive or motor, to alert people that surfaces may reach dangerous temperatures.

Introduction

The release of this document contains new and updated information. To find new and updated information, look for change bars, as shown next to this paragraph.

Updated Information

The document contains these changes.

Topic	Page
1756-L64 ControlLogix Controller	Throughout manual
Add-On Instructions	73
Select a System Overhead Percentage	79
Add Your Axes	100
Obtain Axis Information	108

Notes:

	Preface	
	About this Publication	9
	Who Should Use This Publication	9
	Additional Resources	9
	Chapter 1	
ControlLogix System Overview	Introduction	11
	Design	13
	Install Hardware	13
	Chapter 2	
Directly Connect to the Controller via the Serial Port	Introduction	15
	Connect the Controller to via the Serial Port	15
	Configure the Serial Driver	17
	Select the Controller Path	19
	Chapter 3	
Communicate over Networks	Introduction	21
	EtherNet/IP Network Communication	22
	Connections Over an EtherNet/IP Network	24
	Additional Resources	25
	ControlNet Network Communication	25
	Connections Over a ControlNet Network	27
	Additional Resources	28
	DeviceNet Network Communication	28
	Connections over DeviceNet	30
	Additional Resources	30
	Serial Network Communication	31
	Communicate with DF1 Devices	32
	Communicate with ASCII Devices	34
	Modbus Support	37
	DH-485 Network Communication	37
	Additional Resources	41
	DH+ Network Communication	41
	Communicate over a DH+ Network	42
	Universal Remote I/O Communication	43
	Communicate Over a Universal Remote I/O Network	44
	Foundation Fieldbus	45
	Additional Resources	45
	HART (Highway Addressable Remote Transducer) Protocol	46
	Additional Resources	46
	Chapter 4	
Manage Controller Communication	Introduction	47
	Connection Overview	47
	Additional Resources	47

Produce and Consume (Interlock) Data 48
 Additional Resources 48
 Send and Receive Messages 49
 Determine Whether to Cache Message Connections 49
 Calculate Connection Use 50
 Connections Example 52

Chapter 5

Place, Configure, and Monitor I/O Modules

Introduction 53
 Select I/O Modules 53
 Additional Resources 53
 Place Local I/O Modules 54
 Additional Resources 54
 Configure I/O 55
 I/O Connections 56
 Additional Resources 56
 Configure Distributed I/O on an EtherNet/IP Network 57
 Additional Resources 57
 Configure Distributed I/O on a ControlNet Network 58
 Additional Resources 58
 Configure Distributed I/O on a DeviceNet Network 59
 Additional Resources 59
 Address I/O Data 60
 Add 1756 I/O at Runtime 61
 ControlNet I/O Considerations 61
 EtherNet/IP I/O Considerations 62
 Determine When Data Is Updated 63
 Reconfigure an I/O Module 64
 Reconfigure a Module via RSLogix 5000
 Programming Software 64
 Reconfigure an I/O Module via a MSG Instruction 65

Chapter 6

Develop Applications

Introduction 67
 Additional Resources 67
 Manage Tasks 67
 DevelopPrograms 68
 Define Tasks 69
 Define Programs 70
 Define Routines 70
 Sample Controller Projects 71
 Additional Resources 71
 Organize Tags 72
 Select a Programming Language 73
 Add-On Instructions 73

	Additional Resources	75
	Monitor Controller Status	75
	Additional Resources	76
	Monitor Connections	76
	Determine if Communication Has Timed Out with Any Device	76
	Determine if Communication Has Timed Out with a Specific I/O Module	77
	Interrupt the Execution of Logic and Execute the Fault Handler.	78
	Select a System Overhead Percentage	79
	Chapter 7	
Configure PhaseManager	Introduction	83
	Additional Resources	83
	PhaseManager Overview	83
	State Model Overview	85
	How Equipment Changes States	86
	Manually Change States	87
	Compare PhaseManager to Other State Models.	87
	Minimum System Requirements	88
	Equipment Phase Instructions	88
	Chapter 8	
Develop Motion Applications	Introduction	89
	Make the Controller the CST Master	90
	Multiple Controllers in the Chassis	90
	Add the Motion Modules	91
	Additional Information	92
	Add SERCOS Interface Drives	93
	Additional Resources	94
	Set Up Each SERCOS Interface Module	95
	Add the Motion Group	97
	Add Your Axes	100
	Set Up Each Axis.	101
	Check the Wiring of Each Drive.	104
	Additional Resources	105
	Tune Each Axis.	106
	Additional Resources	107
	Obtain Axis Information	108
	Program Motion Control	109
	Additional Resources	110

Configure Redundancy	Chapter 9	
	Introduction	111
	Additional Resources	111
	ControlLogix Redundancy Overview	111
	Build a Redundant System.	113
	System Considerations	114
	ControlNet Considerations in Redundant Systems.	114
	EtherNet/IP Considerations in Redundant Systems	115
	IP Address Swapping.	115
	Redundancy and Scan Time.	116
	Minimum System Requirements	116
SIL 2 Certification	Chapter 10	
	Introduction	117
	SIL 2 Overview	117
	SIL 2 Application.	118
Maintain Nonvolatile Memory	Chapter 11	
	Introduction	119
	Choose a Controller That Has Nonvolatile Memory.	120
	Prevent a Major Fault During a Load.	120
	Use a CompactFlash Reader.	121
	Additional Resources	121
Maintain the Battery	Chapter 12	
	Introduction	123
	Check If the Battery Is Low	124
	Estimate 1756-BA1 Battery Life	124
	Estimate 1756-BA2 Battery Life (1756-L6x series B controllers only)	126
	Estimate Warning Time	127
	Maintain a 1756-BATM Battery Module	128
	Check the BAT LED Indicator.	128
	Store Batteries.	129
	Additional Resources	129
LED Indicators	Appendix A	
	Introduction	131
	Index	

About this Publication

Use this manual to become familiar with the ControlLogix controller and its features. This version of the manual corresponds to controller firmware revision 15.

Who Should Use This Publication

This manual describes the necessary tasks to install, configure, program, and operate a ControlLogix system. In some cases, this manual includes references to additional documentation that provides the more comprehensive details.

Additional Resources

These core documents address the Logix5000 family of controllers:

Catalog Number	Title	Publication
1756-L55Mx 1756-L6x	Logix5000 Controllers Quick Start	1756-QS001
	Logix5000 Controllers Common Procedures Programming Manual	1756-PM001
	Logix5000 Controllers System Reference	1756-QR107
	Logix5000 Process Control and Drives Instructions Reference Manual	1756-RM003
	Logix5000 Process Control and Drives Instructions Reference Manual	1756-RM006
	Logix5000 Controllers Motion Instructions	1756-RM007

To view or download manuals, visit
<http://literature.rockwellautomation.com/literature>.

To obtain a hard copy of a manual, contact your local Rockwell Automation distributor or sales representative.

Notes:

ControlLogix System Overview

Introduction

This chapter provides an overview of the ControlLogix system. The ControlLogix system provides sequential, process, motion, and drive control together with communication and I/O in a chassis-based system. A simple ControlLogix system consists of a stand-alone controller and I/O modules in a single chassis.

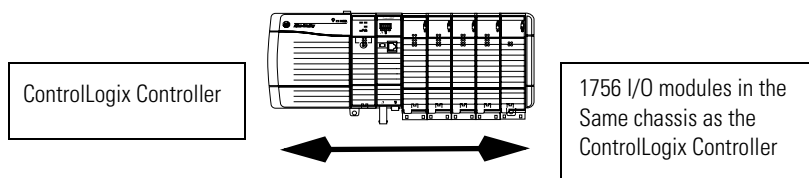

For a more flexible system, use:

- multiple controllers in a single chassis.
- multiple controllers joined across networks.
- I/O from multiple platforms that is distributed in many locations and connected over multiple I/O links.

ControlLogix System Overview

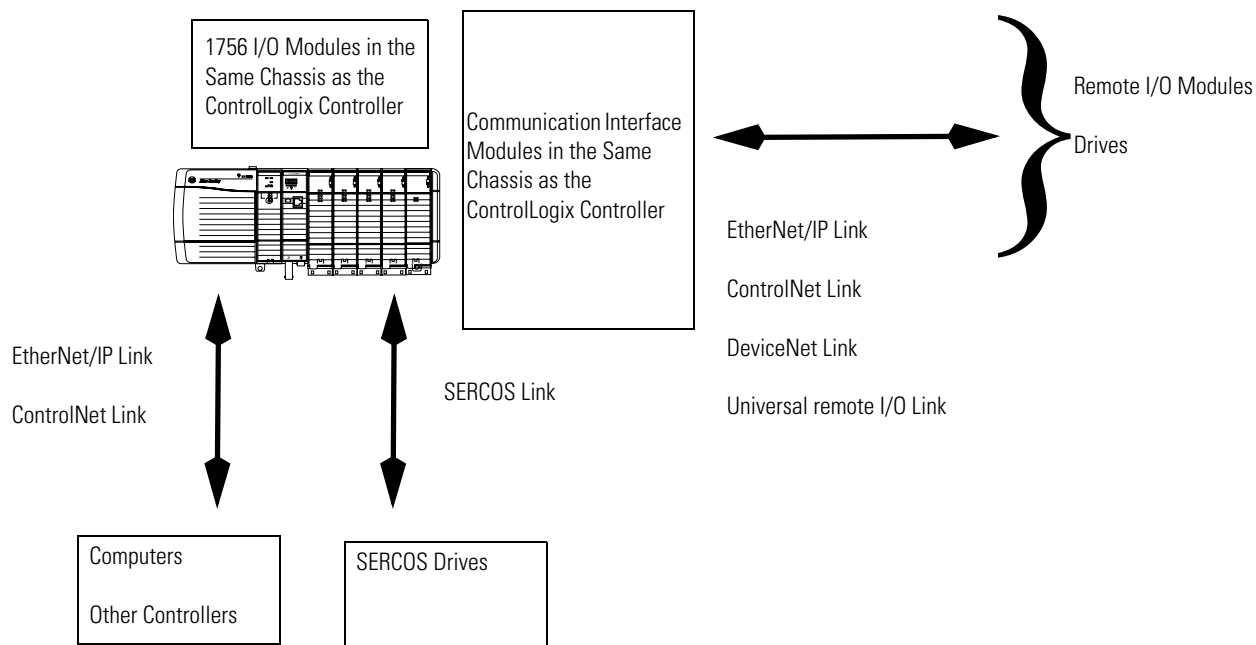

The ControlLogix controller is part of the Logix5000 family of controllers. A ControlLogix system includes:

- the ControlLogix controller is available in different combinations of user memory.

Controller	Memory for Data and Logic	I/O	Nonvolatile Backup Memory
1756-L55M12	750 KB	208 KB	no
1756-L55M13	1.5 MB	208 KB	no
1756-L55M14	3.5 MB	208 KB	no
1756-L55M16	7.5 MB ≤ 3.5 MB of data	208 KB	no
1756-L55M22	750 KB	208 KB	Integrated
1756-L55M23	1.5 KB	208 KB	Integrated
1756-L55M24	3.5 KB	208 KB	Integrated
1756-L61	2 MB	478 KB	CompactFlash ⁽¹⁾ card
1756-L62	4 MB	478 KB	CompactFlash ⁽¹⁾ card
1756-L63	8 MB	478 KB	CompactFlash ⁽¹⁾ card
1756-L64	16 MB	478 KB	CompactFlash ⁽¹⁾ card
1756-L60M03SE	750 KB	478 KB	CompactFlash ⁽¹⁾ card

⁽¹⁾ CompactFlash is optional and does not come with the controller.

- RSLogix 5000 programming software.
- 1756 ControlLogix I/O modules that reside in a 1756 chassis.
- different communication modules for EtherNet/IP, ControlNet, DeviceNet, DH+, and Universal remote I/O networks.
- other networks via third-party devices, such as Foundation Fieldbus and the Highway Addressable Remote Transducer (HART).
- a built-in serial port on every ControlLogix controller.

The ControlLogix controller divides resources between a Logix CPU and a backplane CPU.

Logix CPU and Backplane CPU

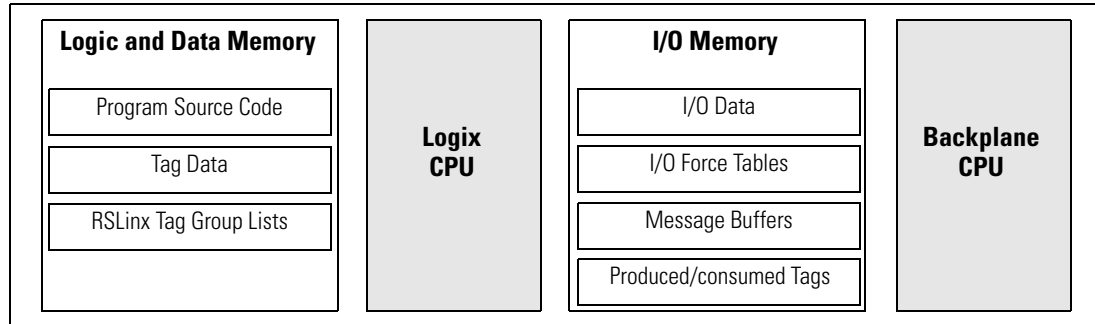

- The Logix CPU executes application code and messages.
- The backplane CPU communicates with I/O and sends and receives data from the backplane. This CPU operates independently from the Logix CPU, so it sends and receives I/O information asynchronous to program execution.

Design

When you design a ControlLogix system, select:

- I/O devices.
- motion control and drives requirements.
- communication modules.
- controllers.
- chassis.
- power supplies.
- software.

Install Hardware

To install a ControlLogix controller:

- install memory options.
 - on a 1756-L55, install a memory board for additional memory.
 - on a 1756-L6x, install a 1784-CF64 CompactFlash card for nonvolatile memory.

See the chapter Maintain Nonvolatile Memory.

- connect the battery.

See the chapter Maintain the Battery.

- install the controller in the chassis.

- make serial connections.

See the chapter *Directly Connect to the Controller via the Serial Port*.

- load controller firmware.
- make additional network connections.

See the chapter *Communicate over Networks*.

Directly Connect to the Controller via the Serial Port

Introduction

This chapter explains how to connect the controller to the serial port and how to upload and download a project to the controller.

Topic	Page
Connect the Controller to via the Serial Port	15
Configure the Serial Driver	17
Select the Controller Path	19

Connect the Controller to via the Serial Port

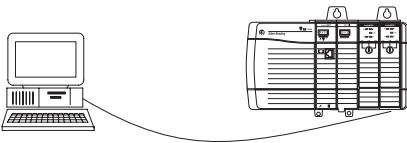

To connect a serial cable, perform this procedure.

1. Obtain a 1756-CP3 serial cable.

You can also use a 1747-CP3 cable from the SLC product family, but once the cable is connected you cannot close the controller door.

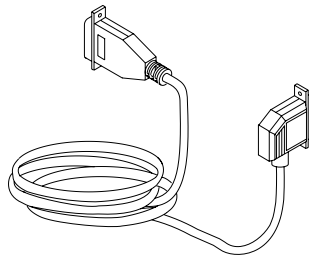

TIP

If you make your own serial cable:

- Limit the length to 15.2m (50 ft).
- Wire the connectors this way.

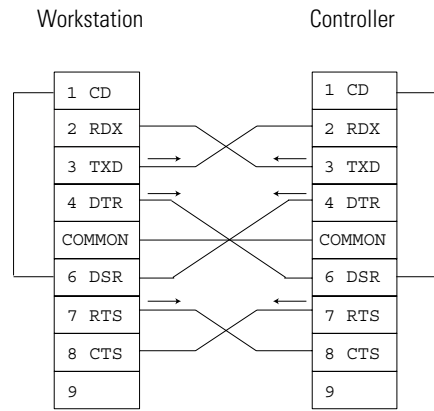

- Attach the shield to both connectors.

2. Connect the cable to the controller and to your workstation.

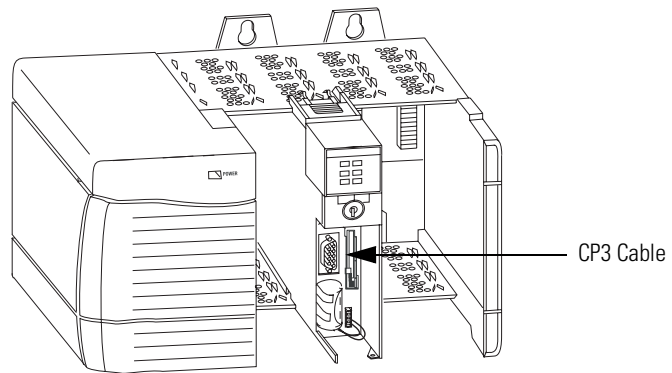

Configure the Serial Driver

Use RSLinx software to configure the RS-232 DF1 Device driver for serial communication.

To configure the driver, perform this procedure.

1. From the Communications pull-down menu in RSLinx software, choose Configure Drivers.



The Configure Drivers dialog appears.

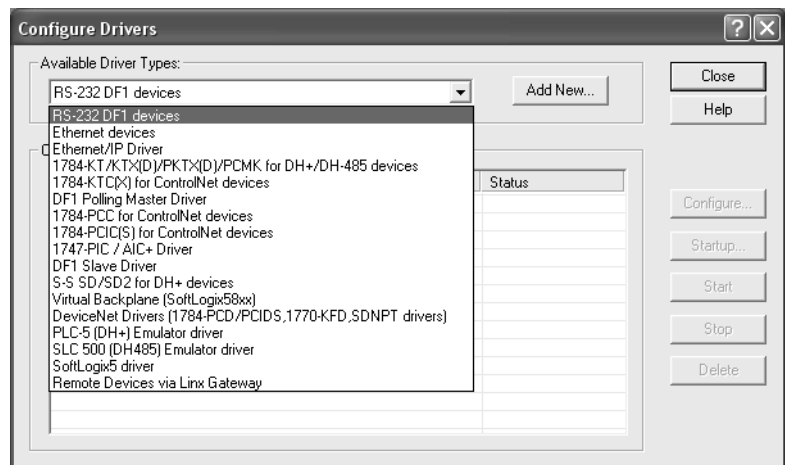

2. From the Available Driver Types pull-down menu, choose the RS-232 DF1 Device driver.
3. Click Add New.

The Add New RSLinx Driver dialog appears.

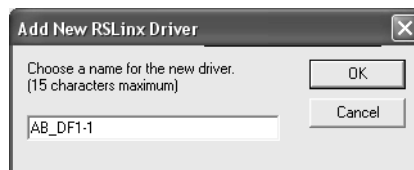

4. Type the driver name and click OK.

5. Specify the serial port settings.
 - a. From the Comm Port pull-down menu, choose the serial port on the workstation to which the cable is connected.
 - b. From the Device pull-down menu, choose Logix 5550-Serial Port.
 - c. Click Auto-Configure.

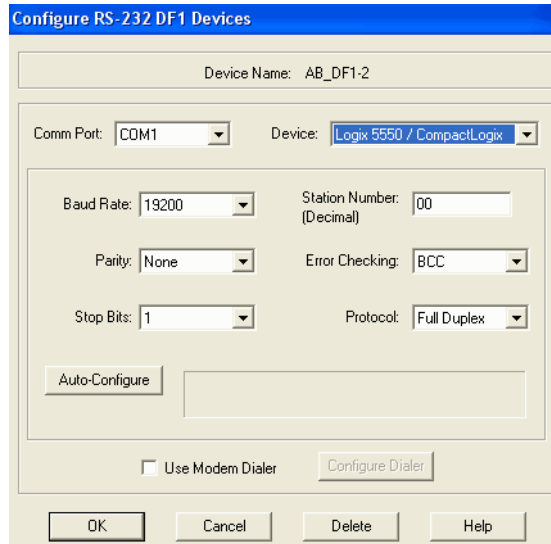

6. Was the auto configuration successful?

If	Then
Yes	Click OK.
No	Go to step 5. and verify that you selected the correct Comm Port.

7. Click Close.

Select the Controller Path

In RSLogix 5000 programming software, to select the controller path, perform this procedure.

1. Open an RSLogix 5000 project for the controller.
2. From the Communications pull-down menu, choose Who Active.
3. Expand the communication driver to the level of the controller.

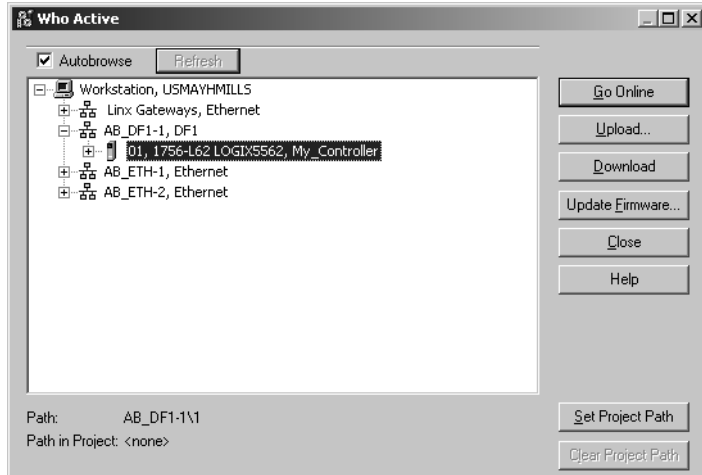

4. Select the controller.

To	Choose
Monitor the project in the controller	Go Online
Transfer a copy of the project from the controller to RSLogix 5000 software	Upload
Transfer the open project to the controller	Download

Notes:

Communicate over Networks

Introduction

This chapter explains over what networks you can communicate.

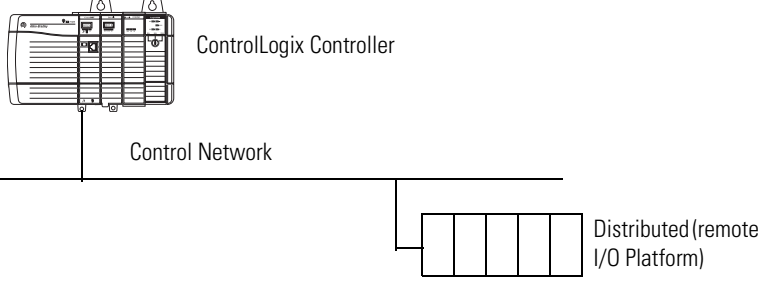
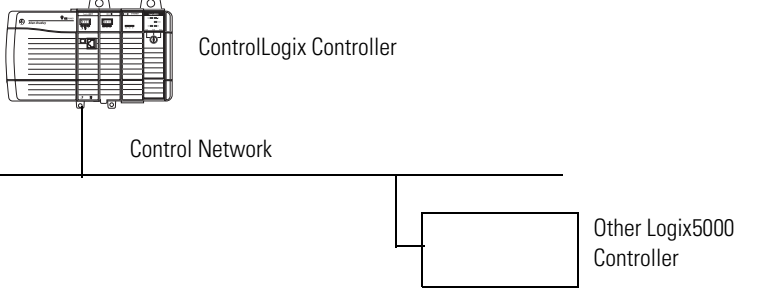
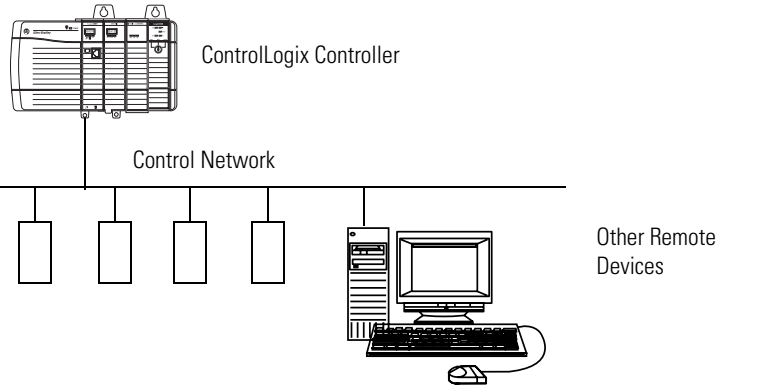
Network Support	Example
<p>Control distributed (remote) I/O</p> <ul style="list-style-type: none"> • EtherNet/IP network • ControlNet network • DeviceNet network • Universal remote I/O network • Foundation Fieldbus network • HART network 	 <p>ControlLogix Controller</p> <p>Control Network</p> <p>Distributed (remote I/O Platform)</p>
<p>Produce/consume (interlock) data between controllers</p> <ul style="list-style-type: none"> • EtherNet/IP network • ControlNet network 	 <p>ControlLogix Controller</p> <p>Control Network</p> <p>Other Logix5000 Controller</p>
<p>Send and receive messages to and from other devices. This includes access to the controller via RSLogix 5000 programming software.</p> <ul style="list-style-type: none"> • EtherNet/IP network • ControlNet network • DeviceNet (to devices only) network • serial network • DH+ network • DH-485 network 	 <p>ControlLogix Controller</p> <p>Control Network</p> <p>Other Remote Devices</p>

Topic	Page
EtherNet/IP Network Communication	22
ControlNet Network Communication	25
DeviceNet Network Communication	28

Topic	Page
Serial Network Communication	31
DH-485 Network Communication	37
DH+ Network Communication	41
Universal Remote I/O Communication	43
Foundation Fieldbus	45
HART	46

EtherNet/IP Network Communication

The EtherNet/IP network offers a full suite of control, configuration, and data collection services by layering the Common Industrial Protocol (CIP) over the standard Internet protocols, such as TCP/IP and UDP. This combination of well-accepted standards provides the capability required to both support information data exchange and control applications.

The EtherNet/IP network also uses commercial, off-the-shelf Ethernet components and physical media, providing you with a cost-effective plant-floor solution.

For EtherNet/IP network communication, you have several communication modules from which to choose.

EtherNet/IP Communication Modules

Functions	Required Module
<ul style="list-style-type: none"> Control I/O modules. Require an adapter for distributed I/O on EtherNet/IP links. Communicate with other EtherNet/IP devices (messages). Share data with other Logix5000 controllers (produce/consume). Bridge EtherNet/IP links to route messages to devices on other networks. 	1756-ENBT
<ul style="list-style-type: none"> Require remote access via Internet browser to tags in a local ControlLogix controller. Communicate with other EtherNet/IP devices (messages). Bridges EtherNet/IP links to route messages to devices on other networks. Does not support I/O or produced/consumed tags. 	1756-EWEB

Required Software for EtherNet/IP Communication

Software	Functions	Requirement
RSLogix 5000	<ul style="list-style-type: none"> • Configure ControlLogix projects. • Define EtherNet/IP communication. 	Yes
RSLogix 5000 BOOTP/DHCP Utility	Assign IP addresses to devices on an EtherNet/IP network.	No
RSNetWorx for EtherNet/IP	<ul style="list-style-type: none"> • Configure EtherNet/IP devices by IP addresses and/or host names. • Provide bandwidth status. 	
RSLinx	<ul style="list-style-type: none"> • Configure communication devices. • Provide diagnostics. • Establish communication between devices. 	Yes

The EtherNet/IP communication modules:

- support messaging, produced/consumed tags, HMI, and distributed I/O.
- encapsulate messages within standard TCP/UDP/IP protocol.
- share a common application layer with ControlNet and DeviceNet networks.
- connect via RJ45 cable.
- support half/full duplex 10 MB or 100 MB operation.
- support standard switches.

In this example:

- The controllers produce and consume tags.
- The controllers initiate MSG instructions that send and receive data or configure devices.
- The personal computer uploads and downloads projects to the controllers.
- The personal computer configures devices on an EtherNet/IP network.

EtherNet/IP Network Overview

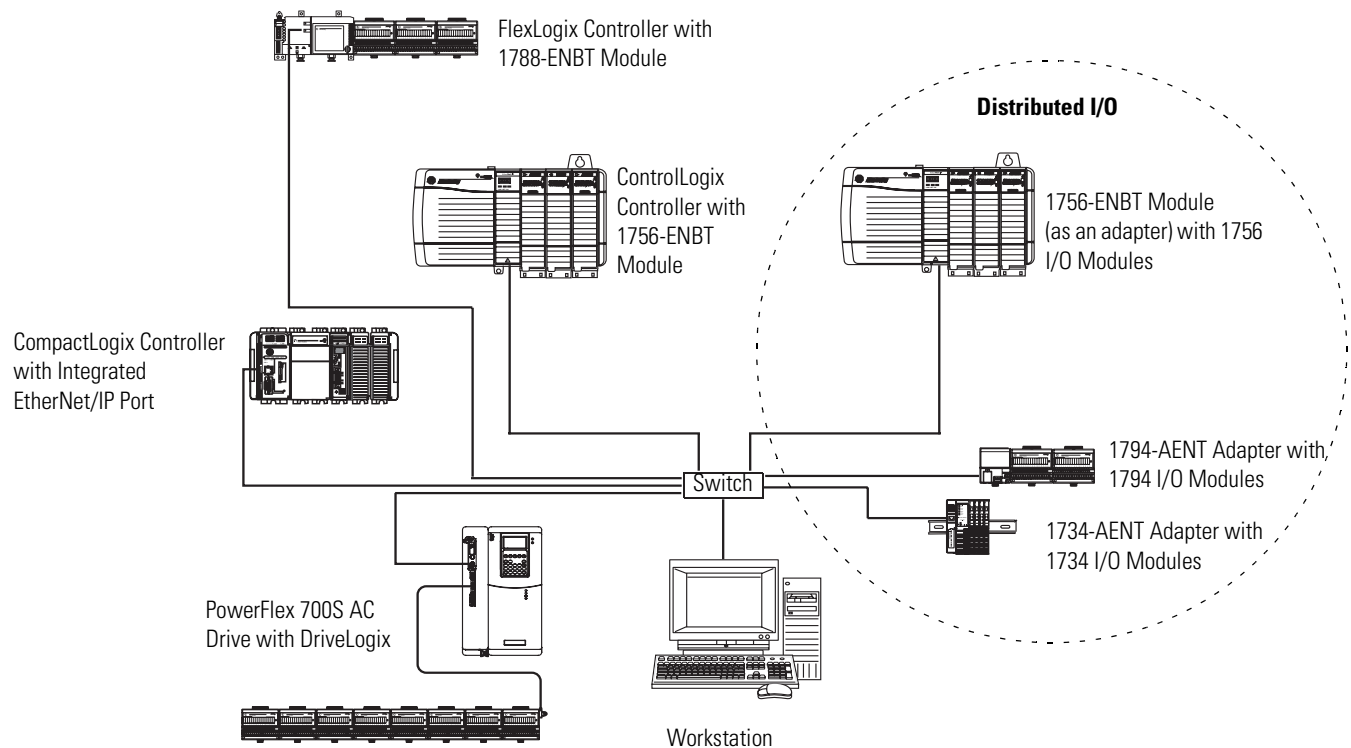

Connections Over an EtherNet/IP Network

You indirectly determine the number of connections the controller uses by configuring the controller to communicate with other devices in the system. Connections are allocations of resources that provide more reliable communication between devices compared to unconnected messages.

All EtherNet/IP connections are unscheduled. An unscheduled connection is triggered by the requested packet interval (RPI) for I/O control or the program, such as a MSG instruction. Unscheduled messaging lets you send and receive data when needed.

The 1756 EtherNet/IP communication modules support 128 CIP (Common Industrial Protocol) connections over an EtherNet/IP network.

Additional Resources

For additional information, consult these publications:

- EtherNet/IP Modules in Logix5000 Control Systems User Manual, publication ENET-UM001
- Logix5000 Controllers Design Considerations Reference Manual, publication 1756-RM094

ControlNet Network Communication

The ControlNet network is a real-time control network that provides high-speed transport of both time-critical I/O and interlocking data and messaging data, including uploading and downloading of programming and configuration data on a single physical-media link. The ControlNet network's highly-efficient data transfer capability significantly enhances I/O performance and peer-to-peer communication in any system or application.

The ControlNet network is highly deterministic and repeatable and remains unaffected as devices are connected or disconnected from the network. This robust quality results in dependable, synchronized, and coordinated real-time performance.

The ControlNet network often functions as:

- a substitute/replacement for the remote I/O (RIO) network because the ControlNet network adeptly handles large numbers of I/O points.
- a backbone to multiple distributed DeviceNet networks.
- a peer interlocking network.

For ControlNet communication, you have two communication modules from which to choose.

ControlNet Communication Modules

Functions	Required Module
<ul style="list-style-type: none"> • Control I/O modules. • Require an adapter for distributed I/O on ControlNet links. • Communicate with other ControlNet devices (messages). • Share data with other Logix5000 controllers (produce/consume). • Bridge ControlNet links to route messages to devices on other networks. 	1756-CNB
<ul style="list-style-type: none"> • Perform same functions as a 1756-CNB module. • Support redundant ControlNet media. 	1756-CNBR

Required Software for ControlNet Communication

Software	Functions	Requirement
RSLogix 5000	<ul style="list-style-type: none"> • Configure ControlLogix projects. • Define ControlNet communication. 	Yes
RSNetWorx for ControlNet	<ul style="list-style-type: none"> • Configure ControlNet devices by IP addresses and/or host names. • Schedule a network. 	
RSLink	<ul style="list-style-type: none"> • Configure communication devices. • Provide diagnostics. • Establish communication between devices. 	

The 1756-CNB and 1756-CNBR ControlNet communication modules:

- support messaging, produced/consumed tags and distributed I/O.
- share a common application layer with DeviceNet and EtherNet/IP networks.
- require no routing tables.
- support the use of coax and fiber repeaters for isolation and increased distance
- support redundant media (1756-CNBR module only)

In this example:

- the controllers produce and consume tags.
- the controllers initiate MSG instructions that send and receive data or configure devices.
- the personal computer uploads and downloads projects to the controllers.
- the personal computer configures devices on a ControlNet network, and it can configure the network itself.

ControlNet Network Overview

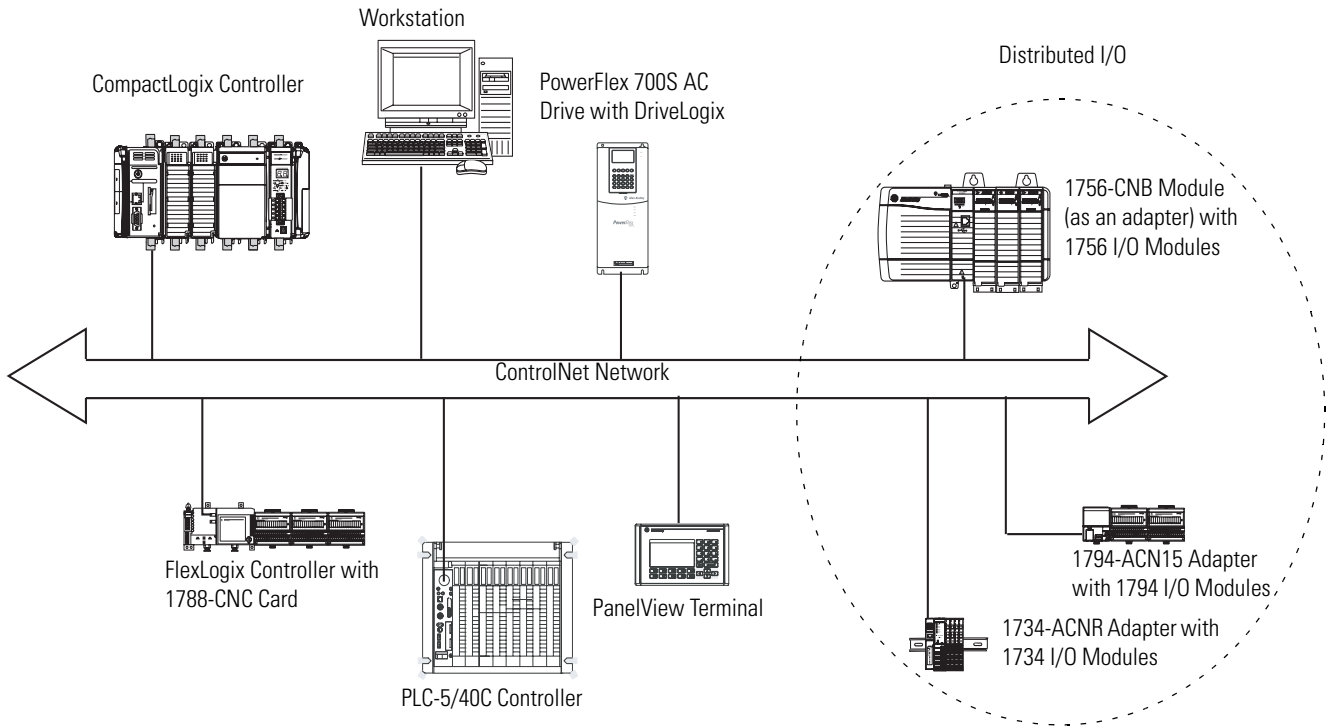

Connections Over a ControlNet Network

You indirectly determine the number of connections the controller uses by configuring the controller to communicate with other devices in the system. Connections are allocations of resources that provide more reliable communication between devices compared to unconnected messages.

ControlNet Connections

Connection	Definition
Scheduled (unique to a ControlNet network)	<p>A scheduled connection is unique to ControlNet communication. A scheduled connection lets you send and receive data repeatedly at a predetermined interval, which is the requested packet interval (RPI). For example, a connection to an I/O module is a scheduled connection because you repeatedly receive data from the module at a specified interval. Other scheduled connections include connections to:</p> <ul style="list-style-type: none"> • communication devices. • produced/consumed tags. <p>On a ControlNet network, you must use RSNetWorx for ControlNet software to enable all scheduled connections and establish a network update time (NUT). Scheduling a connection reserves network bandwidth to specifically handle the connection.</p>
Unscheduled	<p>An unscheduled connection is a message transfer between controllers that is triggered by the requested packet interval (RPI) or the program, such as a MSG instruction. Unscheduled messaging lets you send and receive data when you need to.</p> <p>Unscheduled connections use the remainder of network bandwidth after scheduled connections are allocated.</p>

The 1756-CNB and 1756-CNBR communication modules support 64 CIP connections over a ControlNet network. However, for optimal performance, only configure 48 connections for each module.

Additional Resources

For additional information, consult these publications:

- ControlNet Modules in Logix5000 Control Systems User Manual, publication CNET-UM001
- Logix5000 Controllers Design Guidelines Reference Manual, publication 1756-RM094

DeviceNet Network Communication

The DeviceNet network uses the Common Industrial Protocol (CIP) to provide the control, configuration, and data collection capabilities for industrial devices. The DeviceNet network uses the proven Controller Area Network (CAN) technology, which lowers installation costs and decreases installation time and costly downtime.

A DeviceNet network provides access to the intelligence present in your devices by letting you connect devices directly to plant-floor controllers without having to hard wire each device into an I/O module.

DeviceNet communication requires a 1756-DNB DeviceNet communication module. The DeviceNet network uses the Common Industrial Protocol (CIP) to provide the control, configuration, and data collection capabilities for industrial devices.

Functions	Required Module
<ul style="list-style-type: none"> • Control I/O modules. • Require an adapter for distributed I/O on DeviceNet links. • Communicate with other DeviceNet devices (messages). 	1756-DNB
<ul style="list-style-type: none"> • Link an EtherNet/IP network to a DeviceNet network. • Require multiple networks. 	1788-EN2DN
<ul style="list-style-type: none"> • Link a ControlNet network to a DeviceNet network. • Require multiple networks. 	1788-CN2DN

Required Software for DeviceNet Communication

Software	Functions	Requirement
RSLogix 5000	<ul style="list-style-type: none"> • Configure ControlLogix projects. • Define EtherNet/IP communication. 	Yes
RSNetWorx for DeviceNet	<ul style="list-style-type: none"> • Configure DeviceNet devices. • Define the scan list for those devices. 	
RSLinx	<ul style="list-style-type: none"> • Configure communication devices. • Provide diagnostics. • Establish communication between devices. 	

The DeviceNet communication module:

- supports messaging to devices, not controller to controller.
- shares a common application layer with ControlNet and EtherNet/IP networks.
- offers diagnostics for improved data collection and fault detection.
- requires less wiring than traditional, hardwired systems.

ControlLogix DeviceNet Network Overview

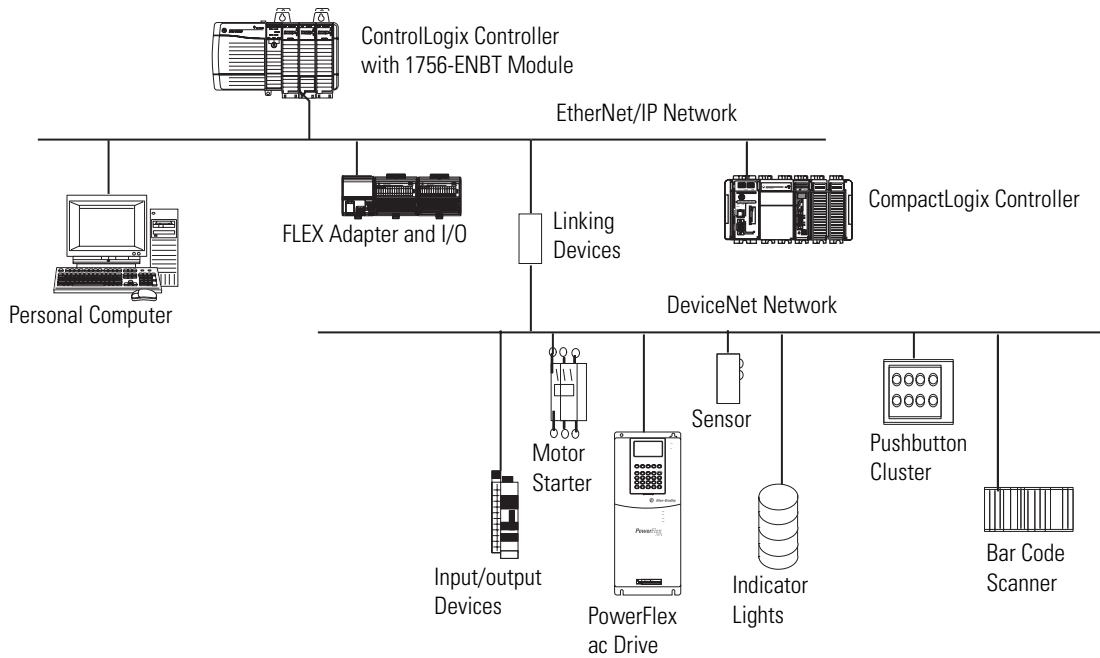

Connections over DeviceNet

The ControlLogix controller requires two connections for each 1756-DNB module. One connection is for module status and configuration. The other connection is a rack-optimized connection for the device data.

The 1756-DNB module has fixed sections of memory for the input and output data of the DeviceNet devices on the network. Each device on your network requires either some input or output memory of the scanner. Some devices both send and receive data, so they need both input and output memory. The 1756-DNB module supports up to:

- 124 DINTs of input data.
- 123 DINTs of output data.

Additional Resources

For more information, consult these publications:

- DeviceNet Modules in Logix5000 Control Systems User Manual, publication DNET-UM004
- Logix5000 Controllers Design Considerations Reference Manual, publication 1756-RM094

Serial Network Communication

The ControlLogix controller has one built-in RS-232 port.

Functions	Required
<ul style="list-style-type: none"> Communicates between a controller and other DF1-compatible devices using DF1 protocols. Uses modems. Controls SCADA applications. Controls ASCII devices. 	Built-in serial port
<ul style="list-style-type: none"> Requires additional RS-232 connections. Requires RS-422 and/or RS-485 connections. 	1756-MVI 1756-MVID

IMPORTANT

Limit the length of RS-232 serial cables to 15.2 m (50 ft).

DF1 Modes for Logix5000 Controllers

Mode	Functions
DF1 point-to-point	<p>Communication between the controller and one other DF1-protocol-compatible device.</p> <p>This is the default system mode. Default parameters are:</p> <ul style="list-style-type: none"> Baud Rate: 19200 Data Bits: 8 Parity: None Stop Bits: 1 Control Line: No Handshake RTS send Delay: 0 RTS Off Delay: 0 <p>This mode is typically used to program the controller through its serial port.</p>
DF1 master mode	<ul style="list-style-type: none"> Control of polling and message transmission between the master and slave nodes. The master/slave network includes one controller configured as the master node and up to 254 slave nodes. Link slave nodes using modems or line drivers. A master/slave network can have node numbers from 0...254. Each node must have a unique node address. Also, at least 2 nodes must exist to define your link as a network, one master and one slave station being the two nodes.
DF1 slave	<ul style="list-style-type: none"> Using a controller as a slave station in a master/slave serial communication network. When there are multiple slave stations on the network, link slave stations using modems or line drivers to the master. When you have a single slave station on the network, you do not need a modem to connect the slave station to the master. You can configure the control parameters for no handshaking. You can connect 2...255 nodes to a single link. In DF1 slave mode, a controller uses DF1 half-duplex protocol. One node is designated as the master and it controls who has access to the link. All the other nodes are slave stations and must wait for permission from the master before transmitting.
User	<ul style="list-style-type: none"> Communication with ASCII devices. This requires your program to use ASCII instructions to read and write data from and to an ASCII device.
DH-485	<p>Communication with other DH-485 devices multi-master, token passing network allowing programming and peer-to-peer messaging.</p>

Communicate with DF1 Devices

You can configure the controller as a master or slave on a serial communication network. Use serial communication to get information to and from remote controllers (stations) when:

- the system contains three or more stations.
- communication occurs on a regular basis and requires leased-line, radio, or power-line modems.

ControlLogix DF1 Device Communication

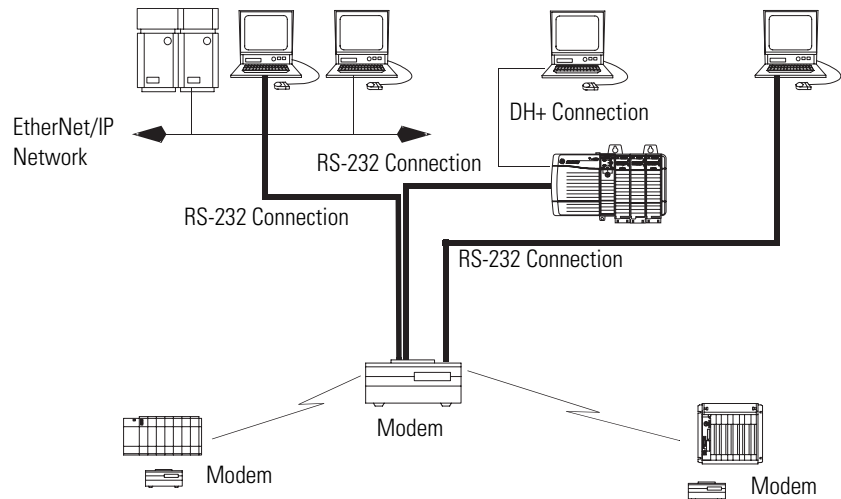

To configure the controller for DF1 communication, perform this procedure.

1. In the Controller Organizer of RSLogix 5000 programming software, right-click your controller and select Properties.

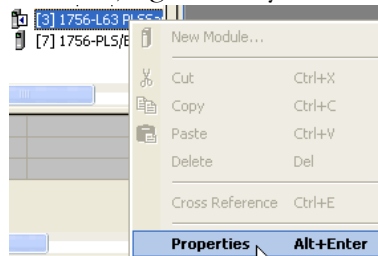

The Controller Properties dialog appears.

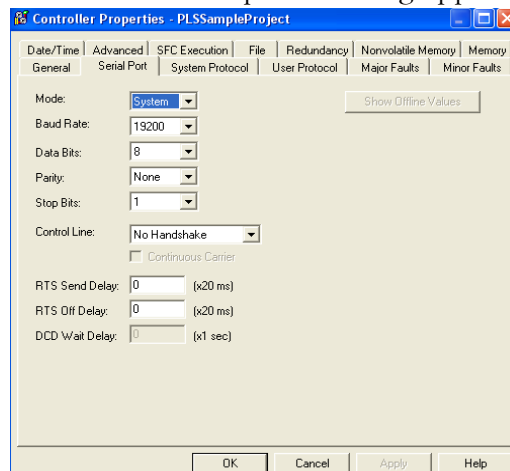

2. Click the Serial Port tab.
3. From the Mode pull-down menu, choose System.
4. Specify DF1 communication settings.
5. Click the System Protocol tab.

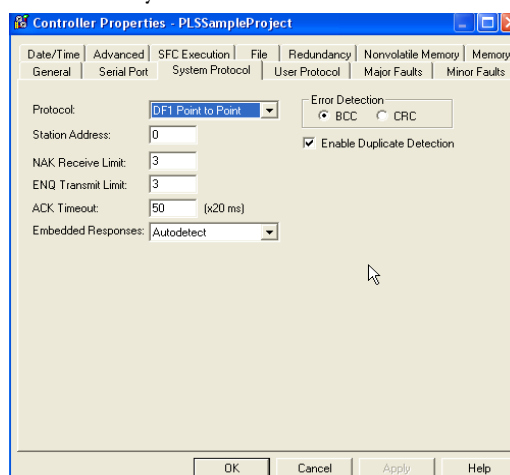

6. From the Protocol pull-down menu, choose DF1 Point-to-Point.
7. Specify DF1 system protocol settings.
8. Click OK.

Additional Resources

For additional information, consult these publications:

- Logix5000 Controllers General Instructions Reference Manual, publication 1756-RM003
- SCADA System Application Guide, publication AG-UM008.

Communicate with ASCII Devices

When you configure the serial port for user mode, you can use it to:

- read ASCII characters from a weigh scale module or bar code reader.
- send and receive messages from an ASCII-triggered device, such as a MessageView terminal.

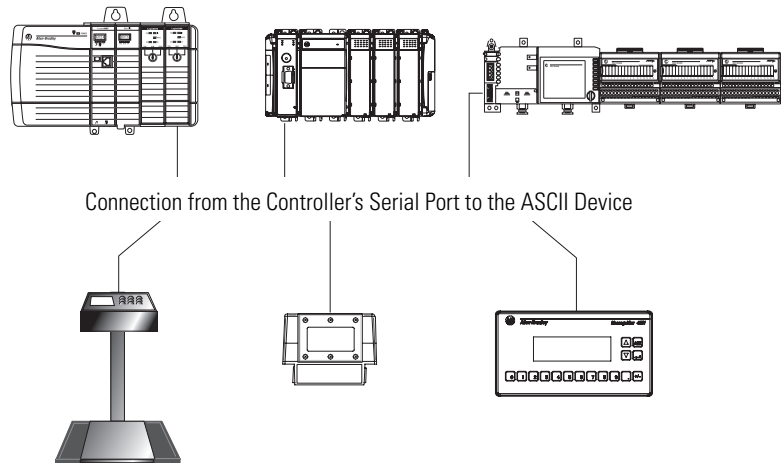

To communicate with ASCII devices, perform this procedure.

1. In the Controller Organizer of RSLogix 5000 programming software, right-click your controller and select Properties.

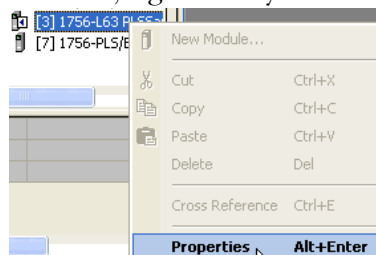

The Controller Properties dialog appears.

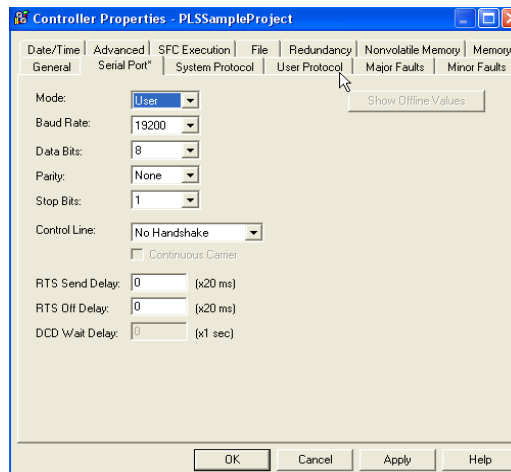

2. Click the Serial Port tab.
3. From the Mode pull-down menu, choose User.
4. Specify ASCII communication settings.
5. Click the User Protocol tab.

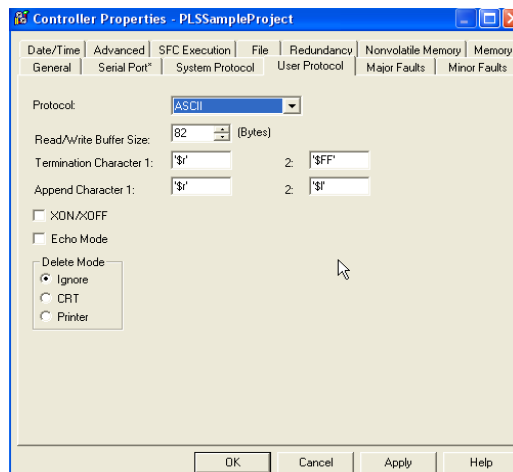

6. Specify ASCII user protocol settings.
7. Click OK.

The controller supports several ladder diagram (LD) and structured text (ST) instructions to manipulate ASCII characters.

Read and Write ASCII Characters

Instruction Code	Command
ABL	Determine when the buffer contains termination characters
ACB	Count the characters in the buffer
ACL	Clear the buffer
	Clear out ASCII Serial Port instructions that are currently executing or are in the queue
AHL	Obtain the status of the serial port control lines
	Turn on or off the DTR signal
	Turn on or off the RTS signal
ARD	Read a fixed number of characters
ARL	Read a varying number of characters, up to and including the first set of termination characters
AWA	Send characters and automatically append one or two additional characters to mark the end of the data
AWT	Send characters

Create and Modify Strings of ASCII Characters

Instruction Code	Command
CONCAT	Add characters to the end of a string
DELETE	Delete characters from a string
FIND	Determine the starting character of a sub-string
INSERT	Insert characters into a string
MID	Extract characters from a string

Convert Data to or from ASCII Characters

Instruction Code	Command
STOD	Convert the ASCII representation of an integer value to a SINT, INT, DINT, or REAL value
STOR	Convert the ASCII representation of a floating-point value to a REAL value
DTOS	Convert a SINT, INT, DINT, or REAL value to a string of ASCII characters
RTOS	Convert a REAL value to a string of ASCII characters
UPPER	Convert the letters in a string of ASCII characters to upper case
LOWER	Convert the letters in a string of ASCII characters to lower case

Additional Resources

For additional information, consult these publications:

- Logix5000 Controllers General Instructions Reference Manual, publication 1756-RM003
- Logix5000 Controllers Common Procedures Programming Manual, publication 1756-PM001

Modbus Support

To use Logix5000 controllers on the Modbus protocol, establish a serial port connection and execute a specific ladder-logic routine. The controller project is available with RSLogix 5000 programming software.

Additional Resources

For additional information, consult Using Logix5000 Controllers as Masters or Slaves on Modbus Application Solution, publication CIG-AP129.

DH-485 Network Communication

For DH-485 communication, use the serial port of the controller. The controller can send and receive messages to and from other controllers on a DH-485 network. The DH-485 connection supports remote programming and monitoring via RSLogix 5000 programming software. However, excessive traffic over a DH-485 connection can adversely affect overall performance and lead to timeouts and decreased RSLogix 5000 configuration performance.

IMPORTANT

Use Logix5000 controllers on DH-485 networks only when you want to add controllers to an existing DH-485 network. For new applications with Logix5000 controllers, we recommend you use networks in the NetLinx open architecture.

The DH-485 protocol uses RS-485 half-duplex as its physical interface. RS-485 is a definition of electrical characteristics, not a protocol. You can configure the RS-232 port of the ControlLogix controller to act as a DH-485 interface. By using a 1761-NET-AIC converter and the appropriate RS-232 cable (1756-CP3 or 1747-CP3), a ControlLogix controller can send and receive data on a DH-485 network.

ControlLogix DH-485 Network Communication Overview

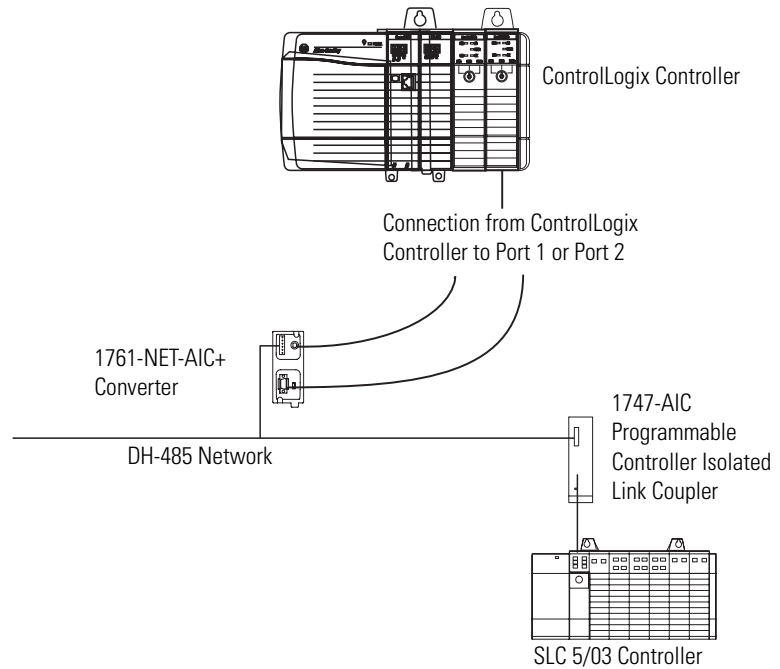

On the DH-485 network, the ControlLogix controller can send and receive messages to and from other controllers.

IMPORTANT

A DH-485 network consists of multiple cable segments. Limit the total length of all the segments to 1219 m (4000 ft).

For the controller to operate on a DH-485 network, you need a 1761-NET-AIC interface converter for each controller you want to put on the DH-485 network.

You can have two controllers for each 1761-NET-AIC converter, but you need a separate cable for each controller. Connect the serial port of the controller to either port 1 or port 2 of the 1761-NET-AIC converter. Use the RS-485 port to connect the converter to the DH-485 network.

Cable Selection

Connection	Required Cable
Port 1 DB-9 RS-232, DTE connection	1747-CP3 or 1761-CBL-AC00
Port 2 Mini-DIN 8 RS-232 connection	1761-CBL-AP00 or 1761-CBL-PM02

To communicate with DH-485 devices, perform this procedure.

1. In the Controller Organizer of RSLogix 5000 programming software, right-click your controller and select Properties.

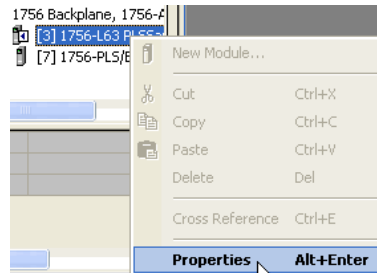

The Controller Properties dialog appears.

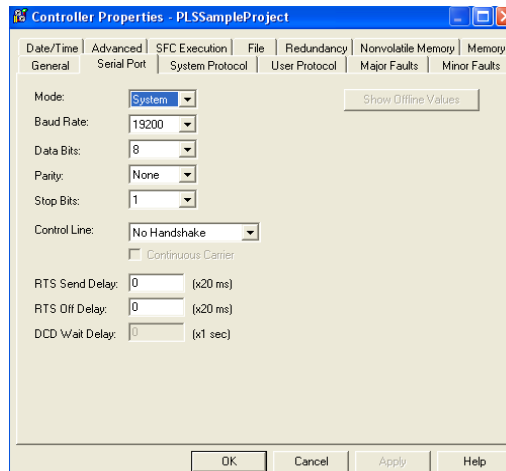

2. Click the Serial Port tab.
3. From the Mode pull-down menu, choose System.
4. Specify DH-485 communication settings.

The baud rate specifies the communication rate for the DH-485 port. All devices on the same DH-485 network must be configured for the same baud rate.

- a. From the Baud Rate pull-down menu, choose 9600 or 19200 kbps.

Click the System Protocol tab.

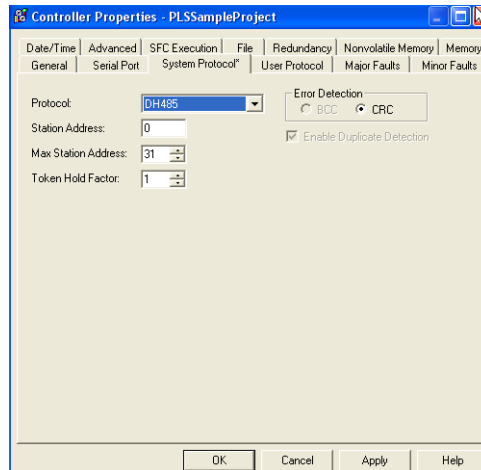

5. Specify system protocol settings.

The station address specifies the node address of the controller on the DH-485 network.

- a. From the Station Address pull-down menu, choose a station address number from 1...31, decimal.

To optimize network performance, assign station addresses in sequential order.

Assign initiators, such as personal computers, the lowest station address numbers to minimize the time required to initialize the network.

The maximum station address specifies the maximum node address of all the devices on the DH-485 network.

- b. From the Max Station Address pull-down menu, choose a maximum station address number from 1...31, decimal.

To optimize network performance, make sure:

- the maximum station address is the highest node number being used on the network.
- that all the devices on the same DH-485 network have the same selection for the maximum station address.

The token hold factor is the number of transmissions (plus retries) that an address holding a token can send onto the data link each time that it receives the token.

- c. In the Token Hold Factor box, enter a token hold factor value from 1...4.

The default is 1.

6. Click OK.

Additional Resources

For more information, consult Data Highway/Data Highway Plus/Data Highway II/Data Highway-485 Cable Installation Manual, publication 1770-6.2.2.

DH+ Network Communication

For DH+ network communication, use a 1756-DHRIO module to exchange information between:

- PLC controllers and SLC controllers.
- ControlLogix controllers and PLC or SLC controllers.
- ControlLogix controllers.

Functions	Required Module
<ul style="list-style-type: none"> • Share data with program maintenance on a plantwide and cell-level basis. • Send data regularly. • Transfer information between controllers. 	1756-DHRIO

You can connect a maximum of 32 stations to a single DH+ link.

- Channel A supports 57.6 Kbps, 115.2 Kbps, and 230.4 Kbps.
- Channel B supports 57.6 Kbps and 115.2 Kbps.

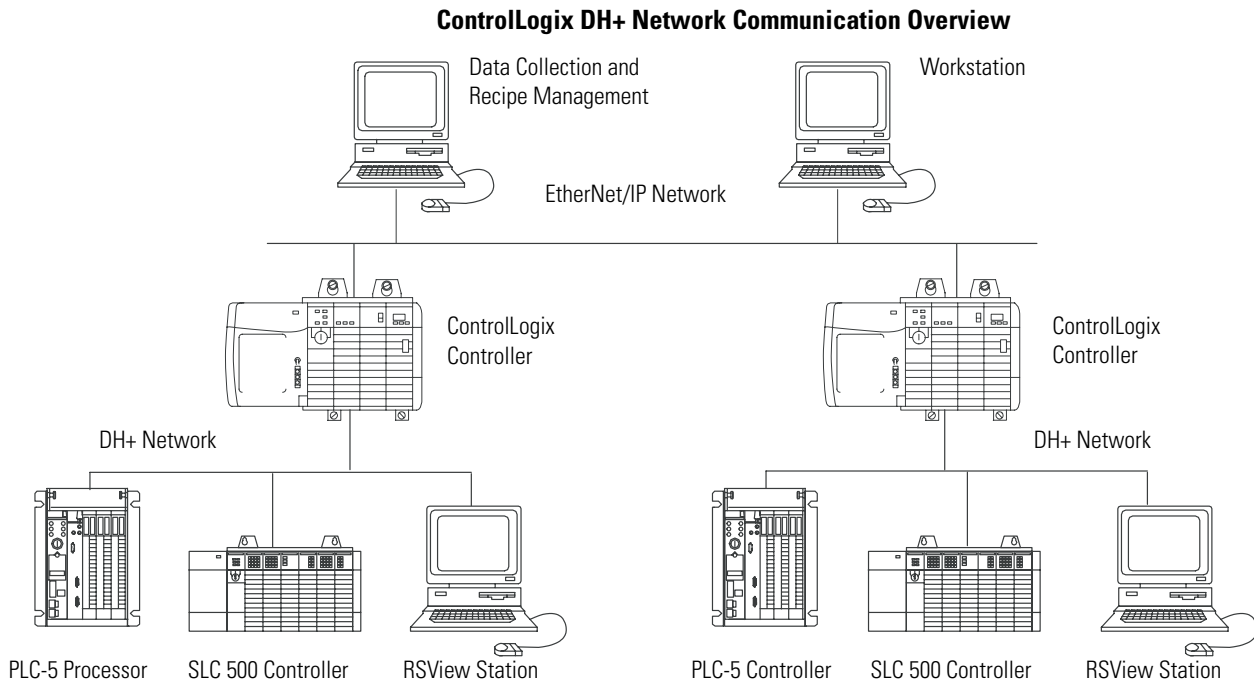

Communicate over a DH+ Network

For the controller to communicate to a workstation or other device over a DH+ network, use RSLinx software to:

- specify a unique link ID for each ControlLogix backplane and additional network in the communication path.
- configure the routing table for the 1756-DHRIO module.

The 1756-DHRIO module can route a message through up to four communication networks and three chassis. This limit applies only to the routing of a message and not to the total number of networks or chassis in a system.

Additional Resources

For additional information, consult the ControlLogix Data Highway Plus - Universal Remote I/O Module User Manual, publication 1756-UM514.

Universal Remote I/O Communication

For universal remote I/O communication, use a 1756-DHRIO module.

Functions	Required Module
<ul style="list-style-type: none"> Establish connections between controllers and I/O adapters. Send data regularly. Distribute control so that each controller has its own I/O. Communicate with a supervisory controller. 	1756-DHRIO
<ul style="list-style-type: none"> Use an RIO scanner. Communicate with as many as 32 RIO adapters. Support HART (Highway Addressable Remote Transducer) devices. Use scheduled connections to update data on a ControlLogix controller. 	1757-ABRIO

When a channel on the 1756-DHRIO module is configured for remote I/O, the module acts as a scanner for a universal remote I/O network. The controller communicates to the module to send and receive the I/O on the universal remote I/O network.

ControlLogix Universal Remote I/O Communication Overview

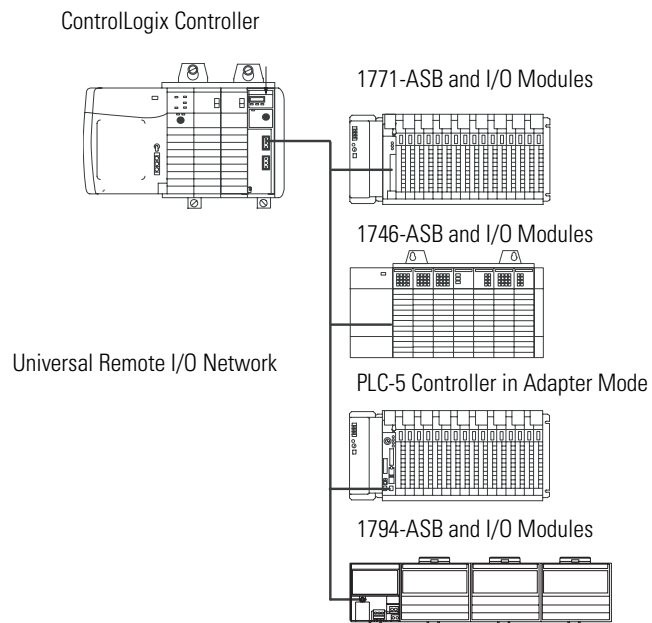

Communicate Over a Universal Remote I/O Network

For the controller to control I/O over a universal remote I/O network, you must perform this procedure.

1. Configure the remote I/O adapter.
2. Lay out the remote I/O network cable.
3. Connect the remote I/O network cable.
4. Configure the scanner channel.

As you design your remote I/O network, remember that:

- all devices connected to a remote I/O network must communicate using the same communication rate. These rates are available for remote I/O:
 - 57.6 Kbps
 - 115.2 Kbps
 - 230.4 Kbps
- you must assign unique partial and full racks to each channel used in remote I/O scanner mode.

Both channels of a 1756-DHRIO module cannot scan the same partial or full rack address. Both module channels can communicate to 00...37 octal or 40...77 octal, but each channel can only communicate with one address at a time in whichever of these two ranges it falls.

- a channel can have up to 32 rack numbers with 32 physical devices connected to it.
- a channel can have a maximum of 16 block-transfer connections.

Additional Resources

For additional information, consult these publications:

- ControlLogix Data Highway Plus - Universal Remote I/O Module User Manual, publication 1756-UM514
- Process Remote I/O Interface Module User Manual, publication 1757-UM007

Foundation Fieldbus

Foundation Fieldbus is an open interoperable fieldbus designed for process control instrumentation.

Application	Required Linking Device
<ul style="list-style-type: none"> • Bridge an EtherNet/IP network to Foundation Fieldbus. • Connect via a low-speed serial (H1) and high-speed Ethernet (HSE) network connections. • Access devices directly via an OPC server. 	1757-FFLD
<ul style="list-style-type: none"> • Connect via low-speed serial (H1) connections. • Bridge a ControlNet network to a Foundation Fieldbus. • Support redundant ControlNet media. 	1788-CN2FF

Foundation Fieldbus distributes and executes control in the device. The Foundation Fieldbus linking device:

- bridges from an Ethernet/IP network to an H1 connection.
- accepts either HSE or EtherNet/IP messages and converts them to the H1 protocol.

Foundation Fieldbus Overview

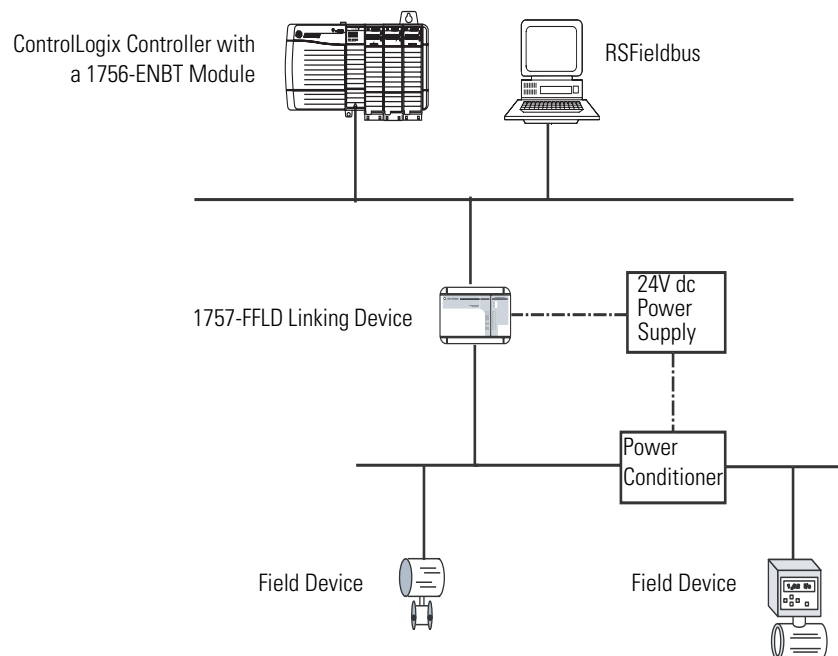

Additional Resources

For additional information, consult these devices:

- RSFieldbus User Manual, publication RSFBUS-UM001
- Foundation Fieldbus Linking Device User Manual, publication 1757-UM010

HART (Highway Addressable Remote Transducer) Protocol

HART is an open protocol designed for process control instrumentation.

Functions	Required Device
<ul style="list-style-type: none"> Acquire data or control application with slow update requirements, such as a tank farm. Does not require external hardware to access HART signal. Does not provide a direct connection to asset management software. 	Prosoft interface MVI56-HART
<ul style="list-style-type: none"> Contain analog and HART in one module. Does not require external hardware to access HART signal. Transmit HART commands as unscheduled messages. Support asset management software to HART device 	Spectrum analog I/O modules <ul style="list-style-type: none"> 1756sc-IF8H 1756sc-OF8H
<ul style="list-style-type: none"> Contain analog and HART in one module. Provide instrumentation in hazardous locations (FLEX Ex). Transmit HART commands as unscheduled messages. Directly connect asset management software to HART devices. 	1794 FLEX I/O modules <ul style="list-style-type: none"> 1794-IE8H 1794-OE8H 1797 FLEX Ex I/O modules <ul style="list-style-type: none"> 1797-IE8H 1797-OE8H

The HART protocol combines digital signals with analog signals to ready the digital signal for the process variable (PV). The HART protocol also provides diagnostic data from the transmitter.

HART Protocol Overview

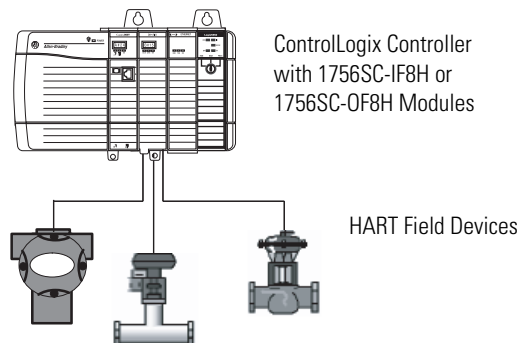

Additional Resources

For additional information, consult these resources:

- FLEX Ex HART Analog Modules User Manual, publication 1797-6.5.3
- Encompass website at <http://automation/rockwell/encompass>

Manage Controller Communication

Introduction

This chapter explains how to manage controller communication.

Topic	Page
Connection Overview	47
Produce and Consume (Interlock) Data	48
Send and Receive Messages	49
Calculate Connection Use	50

Connection Overview

A Logix5000 system uses a connection to establish a communication link between two devices. The types of connections include:

- controller-to-local I/O modules or local communication modules.
- controller-to-remote I/O or remote communication modules.
- controller-to-remote I/O (rack-optimized) modules.
- produced and consumed tags.
- messages.
- controller access by RSLogix 5000 programming software.
- controller access by RSLinx software for HMI or other applications.

Additional Resources

For additional information, consult Logix5000 Controllers Design Considerations Reference Manual, publication 1756-RM094.

Produce and Consume (Interlock) Data

The controller supports the ability to produce (broadcast) and consume (receive) system-shared tags over ControlNet or EtherNet/IP networks. Produced and consumed tags each require connections. Over a ControlNet network, produced and consumed tags are scheduled connections.

Tag Types

Tag Type	Description
Produced	<p>A produced tag lets other controllers to consume the tag, which means that a controller can receive the tag data from another controller. The producing controller uses one connection for the produced tag and one connection for each consumer. The controller's communication device uses one connection for each consumer.</p> <p>As you increase the number of controllers that can consume a produced tag, you also reduce the number of connections the controller and communication device have available for other operations, such as communication and I/O.</p>
Consumed	Each consumed tag requires one connection for the controller that is consuming the tag. The controller's communication device uses one connection for each consumer.

For two controllers to share produced or consumed tags, both must be attached to the same network. You cannot bridge produced and consumed tags over two networks.

The number of available connections limits the number of tags that can be produced or consumed. If the controller uses all of its connections for I/O and communication devices, no connections are left for produced and consumed tags.

Available Connections

Device	Supported Connections
ControlLogix controller	250
<ul style="list-style-type: none"> • 1756-ENBT module • 1756-EWEB module 	128
<ul style="list-style-type: none"> • 1756-CNB module • 1756-CNBR module 	64 48 is the recommended maximum.

Additional Resources

For additional information, consult these publications:

- Logix5000 Controllers Common Procedures Programming Manual, publication 1756-PM001
- Logix5000 Controllers Design Considerations Reference Manual, publication 1756-RM094

Send and Receive Messages

Messages transfer data to other devices, such as other controllers or operator interfaces. Some messages use unscheduled connections to send or receive data. These connected messages can leave the connection open (cache) or close the connection when the message is done transmitting. Each message uses one connection, regardless of how many devices are in the message path. To conserve connections, configure one message to read from or write to multiple devices.

Message Types

Message Type	Communication Method	Connected Message	Message Can Be Cached
CIP data table read or write	N/A	Yes	Yes
PLC-2, PLC-3, PLC-5, or SLC (all types)	CIP	No	No
	CIP with Source ID	No	No
	DH+	Yes	Yes
CIP generic	N/A	Optional ⁽¹⁾	Yes ⁽²⁾
Block-transfer read or write	N/A	Yes	Yes

⁽¹⁾ You can connect CIP generic messages. However, for most applications we recommend you leave CIP generic messages unconnected.

⁽²⁾ Consider caching only if the target module requires a connection.

Each message uses one connection, regardless of how many devices are in the message path. You can programmatically change the target of a MSG instruction to optimize message transfer time.

Determine Whether to Cache Message Connections

When you configure a MSG instruction, you can choose whether or not to cache the connection.

Caching Message Connections

Message Execution	Function
Repeatedly	Cache the connection. This keeps the connection open and optimizes execution time. Opening a connection each time the message executes increases execution time.
Infrequently	Do not cache the connection. This closes the connection upon completion of the message, which frees up that connection for other uses.

Additional Resources

For additional information, consult these publications:

- Logix5000 Controllers General Instructions Reference Manual, publication 1756-RM003
- Logix5000 Controllers Common Procedures Programming Manual, publication 1756-PM001

Calculate Connection Use

The total connection requirements of a ControlLogix system include both local and remote connections.

Local Connections

Local Connection Type	Device Quantity	Connections per Device	Total Connections
Local I/O module (always a direct connection)		1	
1756-M16SE, 1756-M08SE, 1756-M02AE servo module		3	
1756-CNB, 1756-CNBR ControlNet communication module		0	
1756-ENBT EtherNet/IP communication module		0	
1756-EWEB EtherNet/IP web server module		0	
1756-DNET DeviceNet communication module		2	
1756-DHRIO DH+/Universal remote I/O communication module		1	
Total			

The number of connections the module itself supports determines how many remote connections the controller can access through that module.

Remote Connections

Remote Connection Type	Device Quantity	Connections per Device	Total Connections
Remote ControlNet communication module			
I/O configured as direct connection (none)		0 or	
I/O configured as rack-optimized connection		1	
Remote I/O module over a ControlNet network (direct connection)		1	
Remote EtherNet/IP communication module			
I/O configured as direct connection (none)		0 or	
I/O configured as rack-optimized connection		1	
Remote I/O module over a EtherNet/IP network (direct connection)		1	
Remote device over a DeviceNet network (accounted for in rack-optimized connection for local 1756-DNB)		0	
Other remote communication adapter		1	
Produced tag		1	
Each consumer		1	
Consumed tag		1	
Message (depending on type)		1	
Block-transfer message		1	
Total			

Connections Example

In this example system, the 1756 ControlLogix controller:

- controls local digital I/O modules in the same chassis.
- controls remote I/O devices on a DeviceNet network.
- sends and receives messages to and from a CompactLogix controller on an EtherNet/IP network.
- produces one tag that the 1794 FlexLogix controller consumes.
- is programmed via RSLogix 5000 programming software.

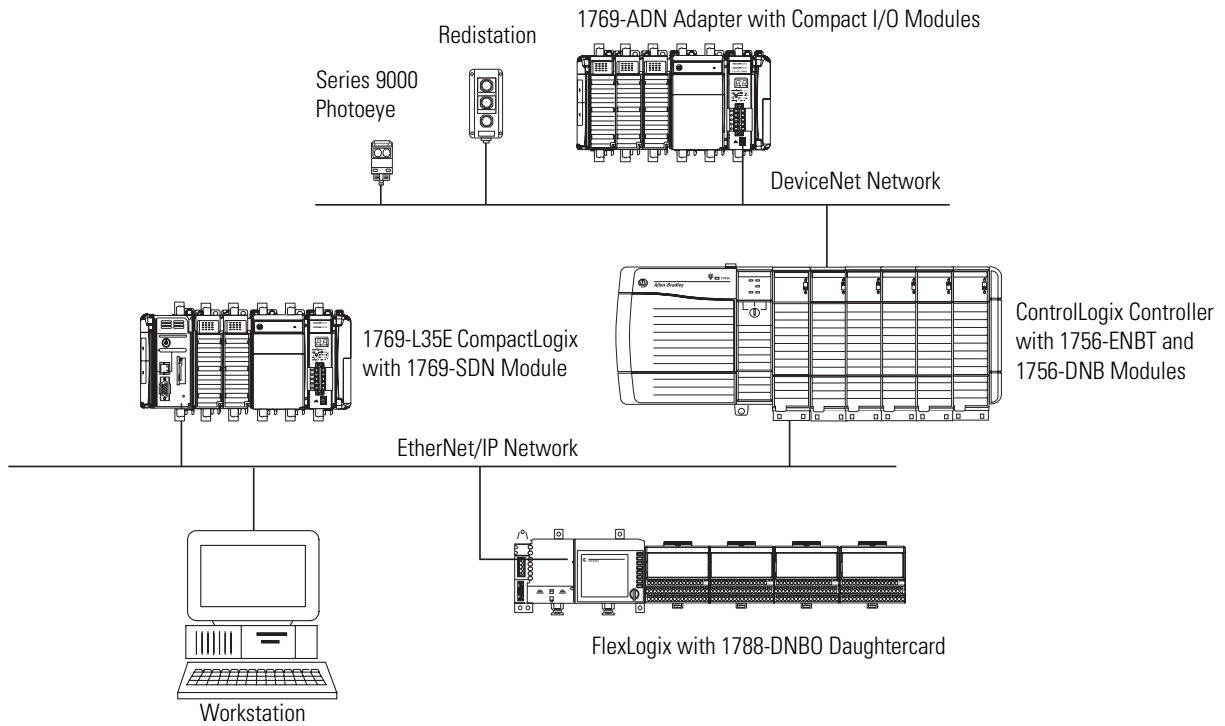

The ControlLogix controller in this example uses these connections:

Example Connection Types

Connection Type	Device Quantity	Connections per Device	Total Connections
Controller to local I/O modules	4	1	1
Controller to 1756-ENBT module	1	0	0
Controller to 1756-DNB module	1	2	2
Controller to RSLogix 5000 programming software	1	1	1
Message to CompactLogix controller	2	1	2
Produced tag	1	1	1
Consumed by FlexLogix controller	1	1	1
Total			8

Place, Configure, and Monitor I/O Modules

Introduction

This chapter explains how to place, configure, and monitor I/O modules.

Topic	Page
Select I/O Modules	53
Place Local I/O Modules	54
Configure I/O	55
Configure Distributed I/O on an EtherNet/IP Network	57
Configure Distributed I/O on a ControlNet Network	58
Configure Distributed I/O on a DeviceNet Network	59
Address I/O Data	60
Add 1756 I/O at Runtime	61
Determine When Data Is Updated	63
Reconfigure an I/O Module	64

Select I/O Modules

When selecting 1756 I/O modules, select:

- specialty I/O modules, when appropriate.

Some modules have field-side diagnostics, electronic fusing, or individually-isolated inputs/outputs.

- 1756 remote terminal blocks (RTBs) or 1492 wiring systems for the I/O modules.
- 1492 PanelConnect modules and cables to connect input modules to sensors.

Additional Resources

For additional information, consult the ControlLogix Selection Guide, publication 1756-SG001.

Place Local I/O Modules

Your choice of 1756 chassis determines how many local I/O modules you can use. You can fill your chassis' slots with any combination of controllers, communication modules, and I/O modules.

Available Chassis Slots

Chassis	Available Slots
1756-A4	4
1756-A7	7
1756-A10	10
1756-A13	13
1756-A17	17

For empty slots, use the 1756-N2 slot-filler module.

The ControlLogix controller also supports distributed (remote) I/O via these networks:

- EtherNet/IP
- ControlNet
- DeviceNet
- Universal remote I/O

Additional Resources

For additional information, consult these publications:

- ControlLogix Digital I/O Modules User Manual, publication 1756-UM058
- ControlLogix Analog I/O Modules User Manual, publication 1756-UM009

Configure I/O

To communicate with an I/O module in your system, add the module to the I/O Configuration folder of the controller in RSLogix 5000 programming software.

Addition of I/O Modules

Add I/O modules to the 1756 backplane.

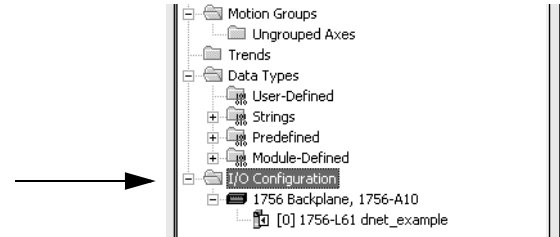

When you add a module, you also define a specific configuration for the module. While the configuration options vary from module to module, there are some common options that you typically configure.

Configuration Options

Configuration Option	Description
Requested Packet Interval (RPI)	<p>The RPI specifies the period at which data updates over a connection. For example, an input module sends data to a controller at the RPI that you assign to the module.</p> <ul style="list-style-type: none"> Typically, you configure an RPI in milliseconds (ms). The range is 0.2...750 ms. If a ControlNet network connects the devices, the RPI reserves a slot in the stream of data flowing across the ControlNet network. The timing of this slot may not coincide with the exact value of the RPI, but the control system guarantees that the data transfers at least as often as the RPI.
Change of State (COS)	<p>Digital I/O modules use COS to determine when to send data to the controller. If a COS does not occur within the RPI, the module multicasts data at the rate specified by the RPI.</p> <p>Because the RPI and COS functions are asynchronous to the logic scan, it is possible for an input to change state during program scan execution. If this is a concern, buffer input data so your logic has a stable copy of data during its scan. Use the Synchronous Copy (CPS) instruction to copy the input data from your input tags to another structure and use the data from that structure.</p>
Communication Format	<p>Many I/O modules support different formats. The communication format that you choose also determines:</p> <ul style="list-style-type: none"> data structure of tags. connections. network usage. ownership. whether the module returns diagnostic information.
Electronic Keying	<p>When you configure a module, you specify the slot number for the module. However, it is possible to purposely or accidentally place a different module in that slot. Electronic keying lets you protect your system against the accidental placement of the wrong module in a slot. The chosen keying option determines how closely any module in a slot must match the configuration for that slot before the controller opens a connection to the module. Keying options differ depending on your application needs.</p>

I/O Connections

A Logix5000 system uses connections to transmit I/O data.

Connection Type	Description
Direct	<p>A direct connection is a real-time, data-transfer link between the controller and an I/O module. The controller maintains and monitors the connection between the controller and the I/O module. Any break in the connection, such as a module fault or the removal of a module while under power, causes the controller to set fault status bits in the data area associated with the module.</p> <p>Typically, analog I/O modules, diagnostic I/O modules, and specialty modules require direct connections.</p>
Rack-optimized	<p>For digital I/O modules, you can select rack-optimized communication. A rack-optimized connection consolidates connection usage between the controller and all of the digital I/O modules on a rack or DIN rail. Rather than having individual, direct connections for each I/O module, there is one connection for the entire rack or DIN rail.</p>

Additional Resources

For additional information, consult these publications:

- Logix5000 Controllers Common Procedures Programming Manual, publication 1756-PM001
- Logix5000 Controllers Design Considerations Reference Manual, publication 1756-RM094

Configure Distributed I/O on an EtherNet/IP Network

To communicate with distributed I/O modules over an EtherNet/IP network, add an EtherNet/IP adapter and I/O modules to the I/O Configuration folder of the controller.

Within the I/O Configuration folder, organize the modules into a hierarchy of tree/branch and parent/child.

Configuring I/O on an EtherNet/IP Network

For a typical distributed I/O network...

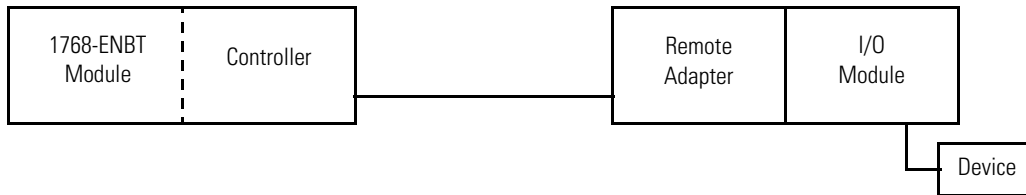

...you build the I/O configuration in this order.

1. Add the remote adapter for the distributed I/O chassis or DIN rail.
2. Add the distributed I/O modules.

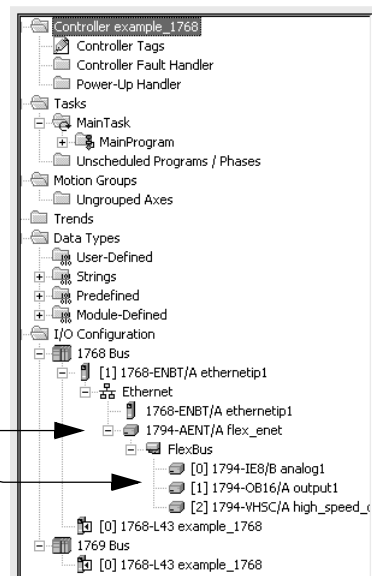

Additional Resources

For additional information, consult EtherNet/IP Communication Modules in Logix5000 Control Systems User Manual, publication ENET-UM001.

Configure Distributed I/O on a ControlNet Network

To communicate with the I/O modules over a ControlNet network, add a ControlNet bridge, ControlNet adapter, and I/O modules to the I/O Configuration folder of the controller.

Within the I/O Configuration folder, organize the modules into a hierarchy of tree/branch and parent/child.

Configuring I/O on a ControlNet Network

For a typical distributed I/O network...

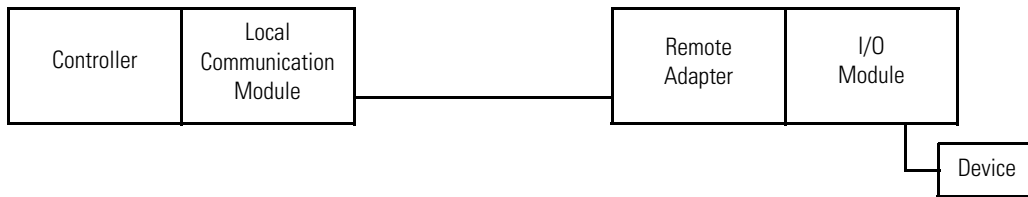

...you build the I/O configuration in this order

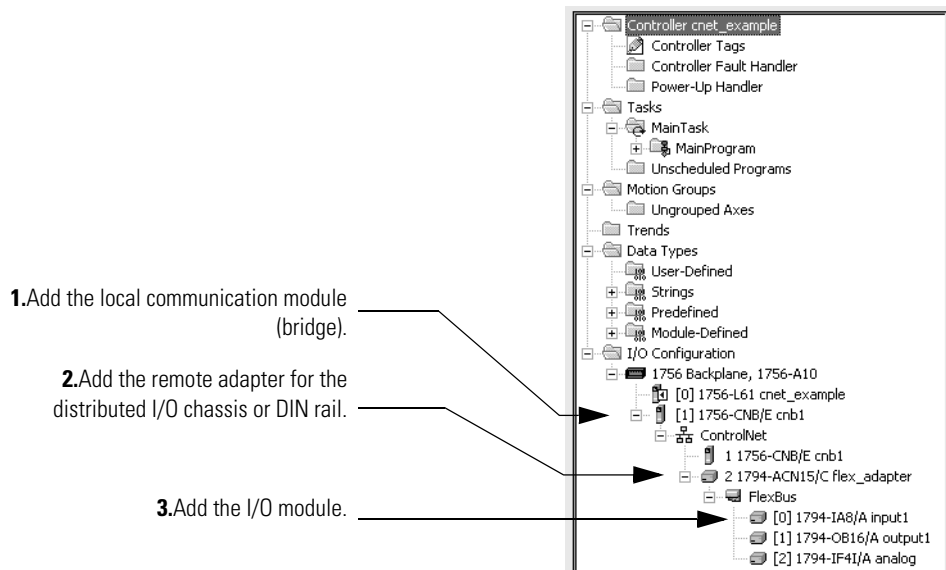

Additional Resources

For additional information, consult ControlNet Modules in Logix5000 Control Systems User Manual, publication CNET-UM001.

Configure Distributed I/O on a DeviceNet Network

To communicate with the I/O modules over a DeviceNet network, add the DeviceNet bridge to the I/O Configuration folder of the controller. You define a scanlist within the DeviceNet scanner to communicate data between devices and the controller.

Configuring Distributed I/O on a DeviceNet Network

For a typical distributed I/O network...

Single Network

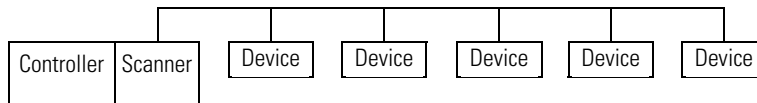

Several Smaller Distributed Networks (subnets)

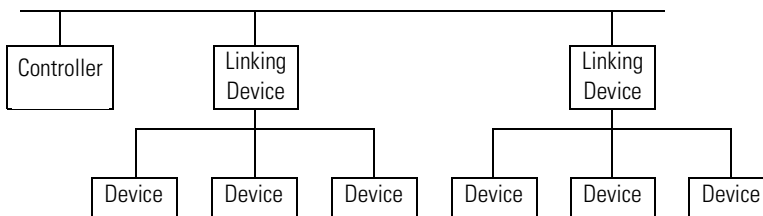

...you build the I/O configuration in this order

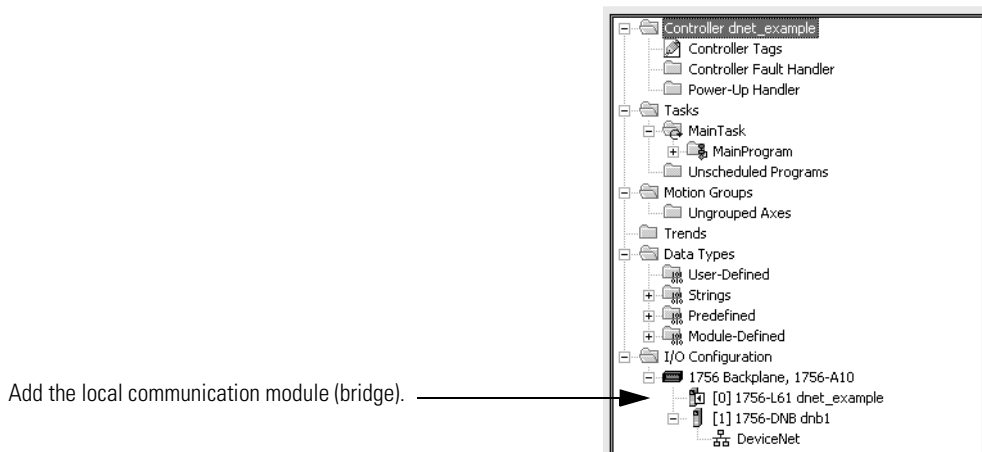

Additional Resources

For additional information, consult DeviceNet Communication Modules in Logix5000 Control Systems User Manual, publication DNET-UM004.

Address I/O Data

I/O information is presented as a set of tags.

- Each tag uses a structure of data. The structure depends on the specific features of the I/O module.
- The name of the tags is based on the location of the I/O module in the system.

An I/O address follows this format.

`Location` `:Slot` `:Type` `.Member` `.SubMember` `.Bit`

= Optional

Where	Definition
<i>Location</i>	Network location LOCAL = same chassis or DIN rail as the controller ADAPTER_NAME = identifies remote communication adapter or bridge module
<i>Slot</i>	Slot number of I/O module in its chassis or DIN rail
<i>Type</i>	Type of data I = input O = output C = configuration S = status
<i>Member</i>	Specific data from the I/O module; depends on what type of data the module can store. <ul style="list-style-type: none"> • For a digital module, a Data member usually stores the input or output bit values. • For an analog module, a Channel member (CH#) usually stores the data for a channel.
<i>SubMember</i>	Specific data related to a Member.
<i>Bit</i>	Specific point on a digital I/O module; depends on the size of the I/O module (0...31 for a 32-point module)

Add 1756 I/O at Runtime

With RSLogix 5000 programming software, version 16, you:

- can only add 1756 I/O modules to the Controller Organizer at runtime.
- can remotely add the 1756 I/O modules to the local chassis via the unscheduled portion of a ControlNet network.
- can remotely add the 1756 I/O modules to the local chassis via the unscheduled portion of an EtherNet/IP network.

ControlNet I/O Considerations

When you add ControlNet I/O at runtime:

- remember that the ControlNet I/O modules you add can be added to existing rack-optimized connections or added as direct connections.

You cannot create new rack-optimized connections when adding ControlNet I/O modules at runtime.

- disable the Change of State (COS) feature on digital input modules because it can cause inputs to be sent more quickly than the RPI.
- dedicate one ControlNet network to I/O communication only. On the dedicated I/O network, make sure there is:
 - no HMI traffic.
 - no MSG traffic.
 - no programming workstations.
- RPIs faster than 25 ms for unscheduled modules will overload the 1756-CNB or 1756-CNBR communication module, so:
 - use a NUT if 10 ms or more.
 - keep the SMAX and UMAX values as small as possible.
- you can add I/O modules until you reach:
 - 75% utilization of the 1756-CNB or 1756-CNBR communication module.
 - a utilization increase of 1...4% for each I/O module you add, depending on the RPI.
 - 48 connections on the 1756-CNB or 1756-CNBR communication module.
 - < 350,000 bytes as the remaining unscheduled bandwidth on the ControlNet network.

EtherNet/IP I/O Considerations

When you add EtherNet/IP I/O at runtime:

- the EtherNet/IP I/O modules you add at runtime use can be:
 - added to existing rack-optimized connections.
 - added to new rack-optimized connections.
 - added as direct connections.

You can create new rack-optimized connections when adding EtherNet/IP I/O modules at runtime.

- you can add I/O modules until you reach the limits of the communication module.

Module Type	Pulses per Second, Max	TCP Connections, Max	CIP Connected Messages, Max	Connected Bridged Messages, Max	Connected End Node Messages, Max	Unconnected Messages, Max
1756-ENBT	4500	64	128	128	32	256
1756-ENET, Series B	810		160			64

Additional Resources

For additional information, consult the EtherNet/IP Performance Application Guide, publication ENET-AP001.

Determine When Data Is Updated

ControlLogix controllers update data asynchronously with the execution of logic. Use this flowchart to determine when a producer, such as a controller, input module, or bridge module, will send data.

Overview - Updating Data

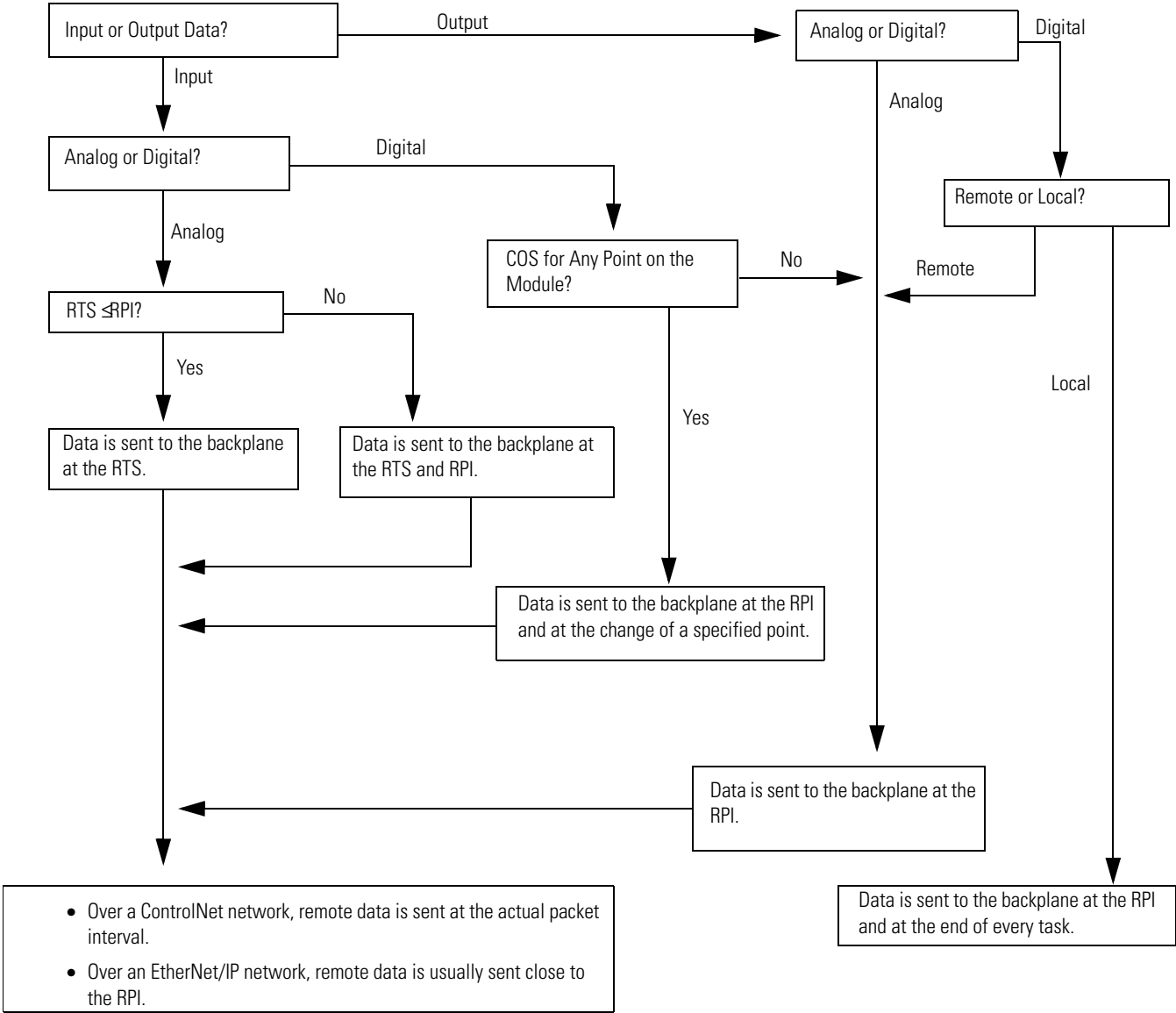

Reconfigure an I/O Module

If an I/O module supports reconfiguration, you can reconfigure the module via:

- RSLogix 5000 programming software.
- a MSG instruction in program logic.

WARNING



Use care when changing the configuration of an I/O module. You could inadvertently cause the I/O module to operate incorrectly.

Reconfigure a Module via RSLogix 5000 Programming Software

To reconfigure a module, perform this procedure.

1. In RSLogix 5000 programming software, right-click a module in the I/O Configuration tree and select Properties.

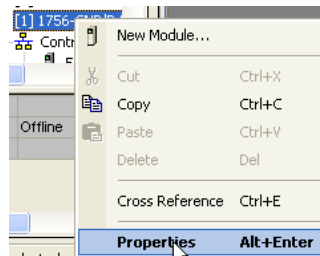

The Module Properties dialog appears.

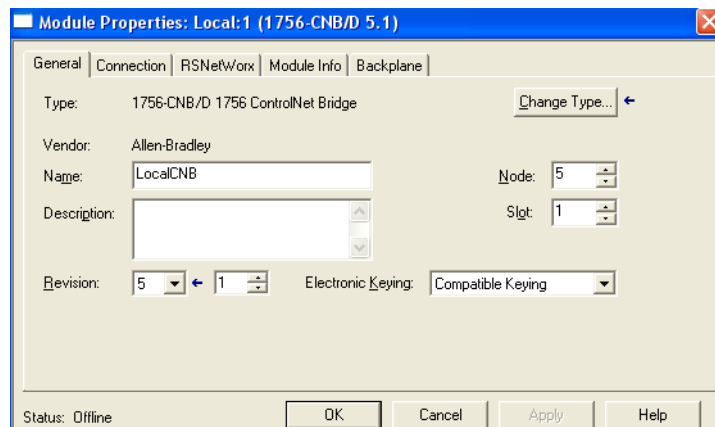

2. Reconfigure the I/O module.
3. Click OK.

Reconfigure an I/O Module via a MSG Instruction

Use a MSG instruction of type Module Reconfigure to send new configuration information to an I/O module. During the reconfiguration:

- input modules continue to send input data to the controller.
- output modules continue to control their output devices.

To reconfigure an I/O module, perform this procedure.

1. Set the required member of the configuration tag of the module to the new value.
2. Send a Module Reconfigure message to the module..

EXAMPLE

Reconfigure an I/O module

When reconfigure[5] is on, the MOV instruction sets the high alarm to 60 for the local module in slot 4. The Module Reconfigure message then sends the new alarm value to the module. The ONS instruction prevents the rung from sending multiple messages to the module while the reconfigure[5] is on.

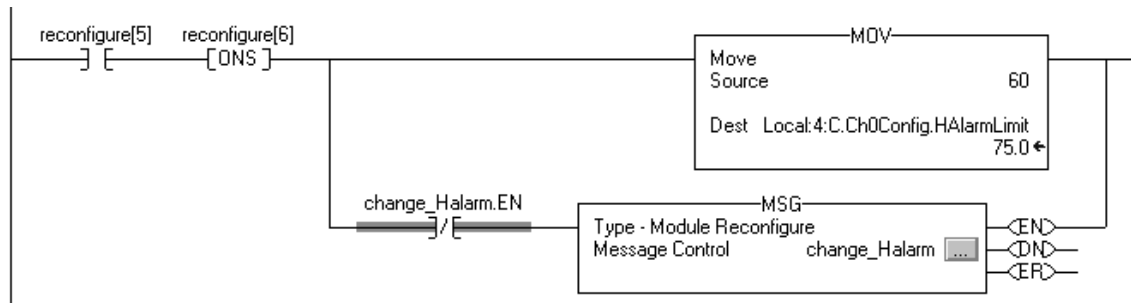

Notes:

Develop Applications

Introduction

This chapter explains how to develop applications.

Topic	Page
Manage Tasks	67
Develop Programs	68
Organize Tags	72
Select a Programming Language	73
Monitor Controller Status	75
Monitor Connections	76
Select a System Overhead Percentage	79

Additional Resources

For additional general information, consult these publications:

- Logix5000 Controllers Common Procedures Programming Manual, publication 1756-PM001.
- Logix5000 Controllers Design Considerations Reference Manual, publication 1756-RM094

Manage Tasks

A Logix5000 controller lets you use multiple tasks to schedule and prioritize the execution of your programs based on specific criteria. This multitasking allocates the controller's processing time among the different operations in your application.

- The controller executes only one task at a time.
- One task can interrupt another execution and take control.
- In any given task, only one program executes at a time.

DevelopPrograms

The controller operating system is a preemptive multitasking system that is IEC 1131-3 compliant. This environment provides:

- tasks to configure controller execution.
- programs to group data and logic.
- routines to encapsulate executable code written in a single programming language.

Program Development Overview

Control Application

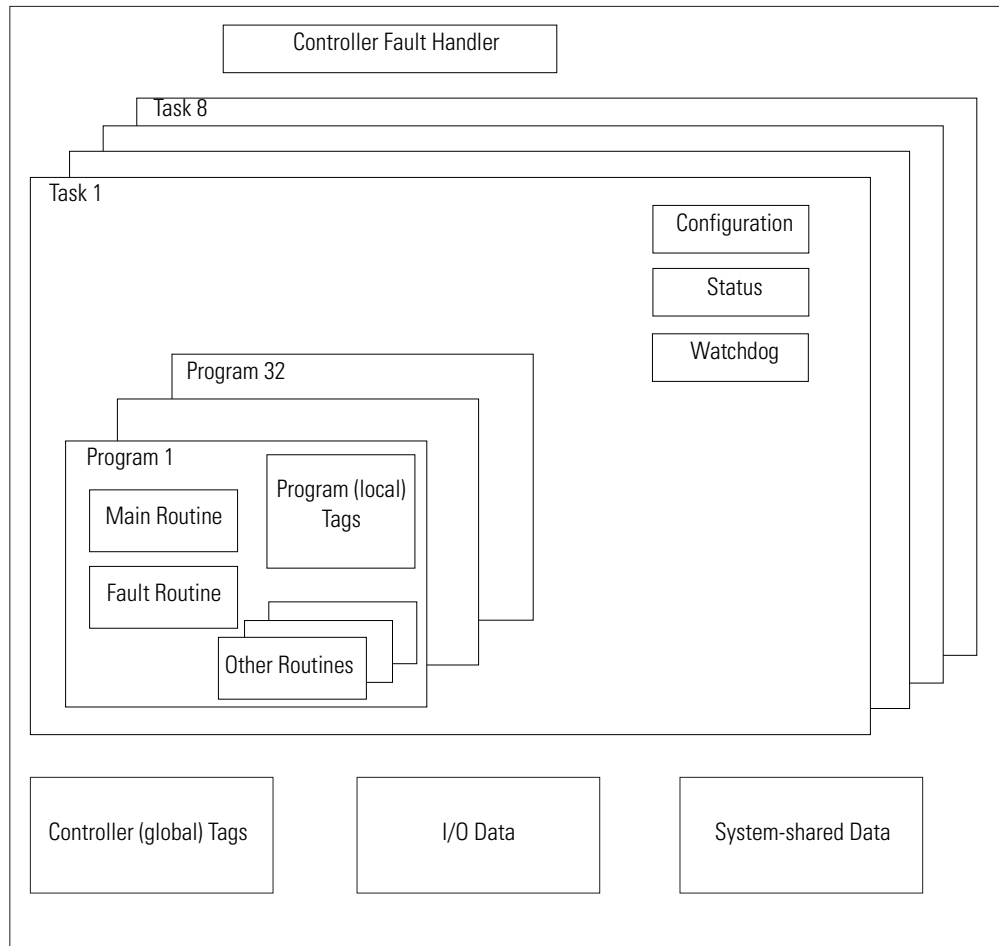

Define Tasks

A task provides scheduling and priority information for a set of one or more programs. You can configure tasks as continuous, periodic, or event.

Types of ControlLogix Controller Tasks

Task Execution	Task Type	Description
All of the time	Continuous	<p>The continuous task runs in the background. Any CPU time not allocated to other operations (such as motion, communication, and other tasks) is used to execute the programs in the continuous task.</p> <ul style="list-style-type: none"> • The continuous task runs constantly. When the continuous task completes a full scan, it restarts immediately. • A project does not require a continuous task. If used, there can be only one continuous task.
<ul style="list-style-type: none"> • At a set interval, such as every 100 ms • Multiple times within the scan of your other logic 	Periodic	<p>A periodic task performs a function at a specific interval.</p> <ul style="list-style-type: none"> • Whenever the time for the periodic task expires, the task interrupts any lower priority tasks, executes once, and then returns control to where the previous task left off. • You can configure the time period from 0.1...2000 μs. The default is 10 ms. It is also controller and configuration dependent. • The performance of a periodic task depends on the type of Logix5000 controller and on the logic in the task.
Immediately when an event occurs	Event	<p>An event task performs a function only when a specific event (trigger) occurs. The trigger for the event task can be:</p> <ul style="list-style-type: none"> • a consumed tag trigger. • an EVENT instruction. • an axis trigger. • a motion event trigger.

The ControlLogix controller supports up to 32 tasks, only one of which can be continuous.

A task can have up to 100 separate programs, each with its own executable routines and program-scoped tags. Once a task is triggered (activated), all the programs assigned to the task execute in the order in which they are grouped. Programs can only appear once in the Controller Organizer and cannot be shared by multiple tasks.

Specify Task Priorities

Each task in the controller has a priority level. The operating system uses the priority level to determine which task to execute when multiple tasks are triggered. You can configure periodic tasks to execute from the lowest priority of 15 up to the highest priority of 1. A higher priority task will interrupt any lower priority task. The continuous task has the lowest priority and is always interrupted by a periodic or event task.

Define Programs

Each program contains program tags, a main executable routine, other routines, and an optional fault routine. Each task can schedule as many as 100 programs.

The scheduled programs within a task execute to completion from first to last. Programs that aren't attached to any task show up as unscheduled programs. You must specify (schedule) a program within a task before the controller can scan the program.

Unscheduled programs within a task are downloaded to the controller with the entire project. The controller verifies unscheduled programs but does not execute them.

Define Routines

A routine is a set of logic instructions in a single programming language, such as Ladder Diagram. Routines provide the executable code for the project in a controller. A routine is similar to a program file or subroutine in a PLC or SLC processor.

Each program has a main routine. This is the first routine to execute when the controller triggers the associated task and calls the associated program. Use logic, such as the Jump to Subroutine (JSR) instruction, to call other routines.

You can also specify an optional program fault routine. The controller executes this routine if it encounters an instruction-execution fault within any of the routines in the associated program.

Sample Controller Projects

RSLogix 5000 Enterprise programming software includes sample projects that you can copy and then modify to fit your application.

To obtain a list of sample projects, perform this procedure.

1. In RSlogix 5000 programming software, from the Help menu, choose Vendor Sample Projects.

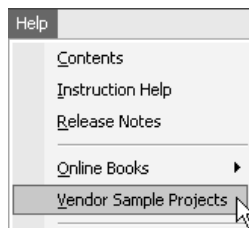

2. Scroll down to select the appropriate set of sample projects.

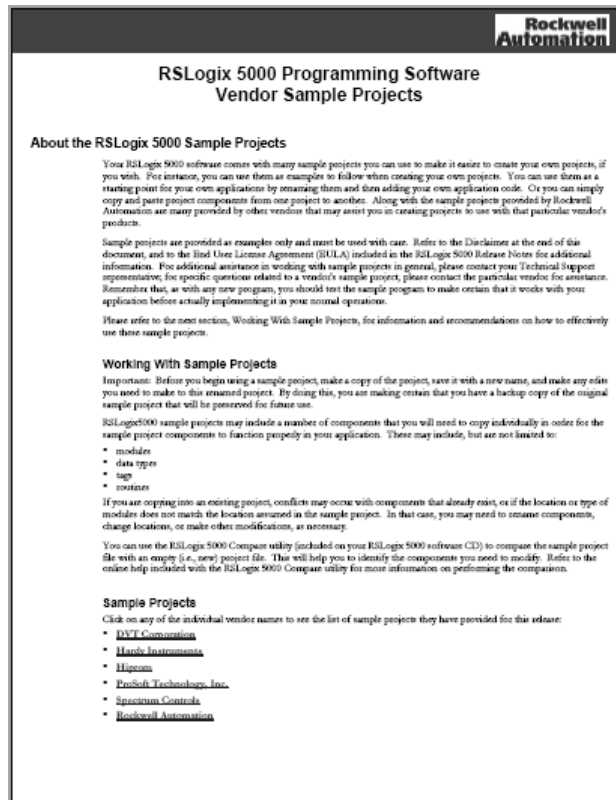

Additional Resources

For more information, consult Logix5000 Controllers Design Considerations Reference Manual, publication 1756-RM094.

Organize Tags

With a Logix5000 controller, you use a tag (alphanumeric name) to address data (variables). In Logix5000 controllers, there is no fixed, numeric format. The tag name itself identifies the data. This lets you:

- organize your data to mirror your machinery.
- document your application as you develop it.

Tag Organization Overview

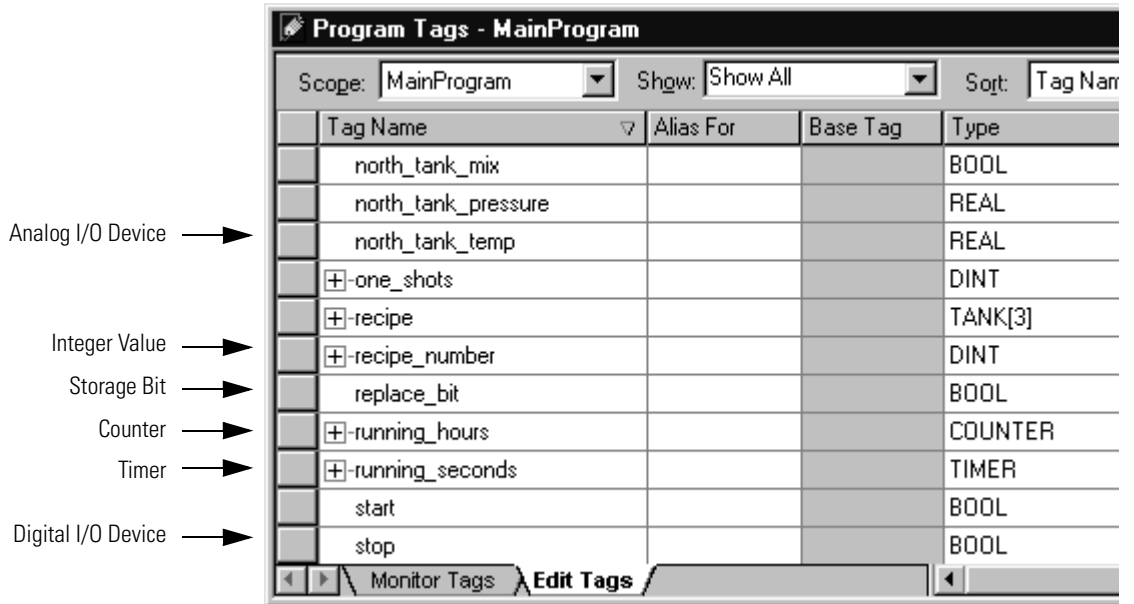

Tag Name	Alias For	Base Tag	Type
north_tank_mix			BOOL
north_tank_pressure			REAL
north_tank_temp			REAL
+one_shots			DINT
+recipe			TANK[3]
+recipe_number			DINT
replace_bit			BOOL
+running_hours			COUNTER
+running_seconds			TIMER
start			BOOL
stop			BOOL

Annotations on the left side of the table:

- Analog I/O Device → REAL
- Integer Value → DINT
- Storage Bit → BOOL
- Counter → COUNTER
- Timer → TIMER
- Digital I/O Device → BOOL

When you create a tag, you assign these properties to the tag:

- tag type
- data type
- scope

Select a Programming Language

The ControlLogix controller supports these programming languages, both online and offline.

Logix5000 Programming Languages

Required Language	Programs
Ladder diagram (LD)	Continuous or parallel execution of multiple operations (not sequenced)
	Boolean or bit-based operations
	Complex logical operations
	Message and communication processing
	Machine interlocking
	Operations that service or maintenance personnel may have to interpret in order to troubleshoot the machine or process
Function block diagram (FBD)	Continuous process and drive control
	Loop control
	Calculations in circuit flow
Sequential function chart (SFC)	High-level management of multiple operations
	Repetitive sequence of operations
	Batch process
	Motion control using structured text
	State machine operations
Structured text (ST)	Complex mathematical operations
	Specialized array or table loop processing
	ASCII string handling or protocol processing

Add-On Instructions

With version 16 of RSLogix 5000 programming software, you can design and configure sets of commonly used instructions to increase project consistency. Similar to the built-in instructions contained in Logix5000 controllers, these instructions you create are called Add-On Instructions. Add-On Instructions reuse common control algorithms. With them, you can:

- ease maintenance by animating logic for a single instance.
- protect intellectual property with locking instructions.
- reduce documentation development time.

You can use Add-On Instructions across multiple projects. You can define your instructions, obtain them from somebody else, or copy them from another project.

Once defined in a project, Add-On Instructions behave similarly to the built-in instructions in Logix5000 controllers. They appear on the instruction tool bar for easy access, as do internal RSLogix 5000 software instructions.

Save Time

With Add-On Instructions, you can combine your most commonly used logic into sets of reusable instructions. You save time when you create instructions for your projects and then share them with others. Add-On Instructions increase project consistency since commonly used algorithms all work in the same manner, regardless of who implements the project.

Use Standard Editors

You create Add-On Instructions by using one of three RSLogix 5000 software programming editors.

- Standard Ladder
- Function Block Diagram
- Structured Text

Once you have created instructions, you can use them in any RSLogix 5000 editor.

Export Add-On Instructions

You can export Add-On Instructions to other projects as well as copy and paste them from one project to another. Give each instruction a unique name so that you don't accidentally overwrite another instruction of the same name.

Use Context Views

Context views let you visualize an instruction's logic for a specific instant, simplifying online troubleshooting of your Add-On Instructions. Each instruction contains a revision, a change history, and an auto-generated help page.

Create Custom Help

When you create an instruction, you enter information for the description fields in software dialogs, information that becomes what is known as Custom Help. Custom Help makes it easier for users to get the help they need when implementing the instructions.

Apply Source Protection

As the creator of Add-On Instructions, you can limit users of your instructions to read-only access, or you can bar access to the internal logic or local parameters used by the instructions. This source protection lets you prevent unwanted changes to your instructions and protects your intellectual property.

Additional Resources

For additional information, consult the Logix5000 Controllers Execution Time and Memory Use Reference Manual, publication 1756-RM087.

Monitor Controller Status

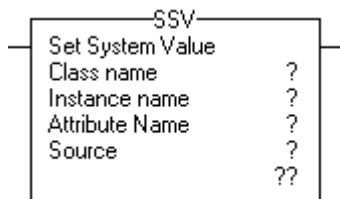
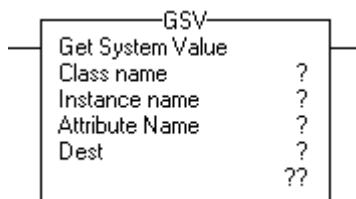

The ControlLogix controller uses Get System Value (GSV) and Set System Value (SSV) instructions to get and set (change) controller data. The controller stores system data in objects. There is no status file, as in the PLC-5 processor.

The GSV instruction retrieves the specified information and places it in the destination. The SSV instruction sets the specified attribute with data from the source.

When you enter a GSV/SSV instruction, the programming software displays the valid object classes, object names, and attribute names for each instruction. For the GSV instruction, you can get values for all the available attributes. For the SSV instruction, the software displays only those attributes you are allowed to set.

Some object types appear repeatedly, so you may have to specify the object name. For example, there can be several tasks in your application. Each task has its own TASK object that you access by the task name.

You can access these object classes:

- AXIS
- CONTROLLER
- CONTROLLERDEVICE
- CST
- DF1
- FAULTLOG
- MESSAGE
- MODULE
- MOTIONGROUP
- PROGRAM
- ROUTINE
- SERIALPORT
- TASK
- WALLCLOCKTIME

Additional Resources

For additional information, consult the Logix5000 Controllers General Instructions Reference Manual, publication 1756-RM003.

Monitor Connections

If communication with a device in the I/O configuration of the controller does not occur for 100 ms or 4 times the RPI, whichever is less, the communication times out and the controller produces these warnings.

- The I/O LED on the front of the controller flashes green.
- A  shows over the I/O configuration folder and over the devices that have timed out.
- A module fault code is produced, which you can access via:
 - the Module Properties dialog.
 - a GSV instruction.

Determine if Communication Has Timed Out with Any Device

If communication times out with at least one device (module) in the I/O configuration of the controller, the I/O LED on the front of the controller flashes green.

- The GSV instruction gets the status of the I/O LED and stores it in the I_O_LED tag.
- If I_O_LED equal 2, the controller has lost communication with at least one device.

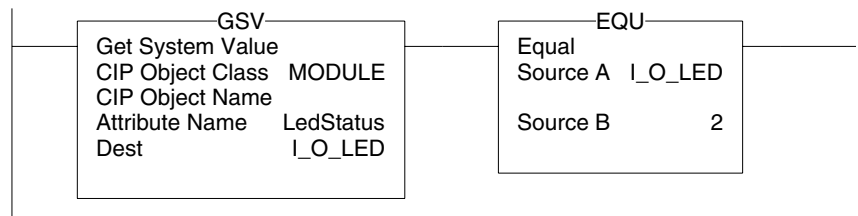

where:

I_O_LED is a DINT tag that stores the status of the I/O LED on the front of the controller.

Determine if Communication Has Timed Out with a Specific I/O Module

If communication times out with a device (module) in the I/O configuration of the controller, the controller produces a fault code for the module.

- The GSV instruction gets the fault code for Io_Module and stores it in the Module_Status tag.
- If Module_Status is any value other than 4, the controller is not communicating with the module.

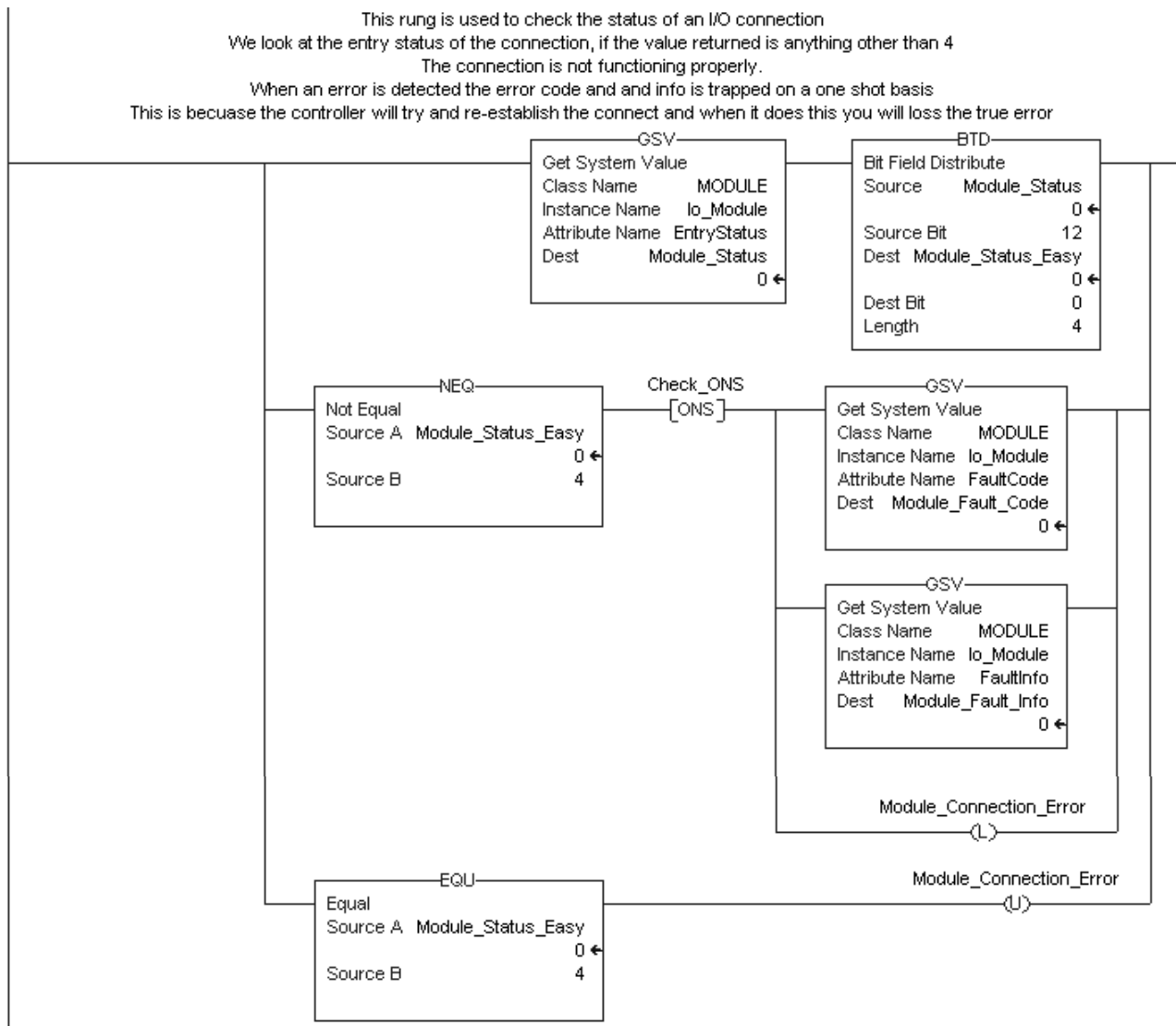

Interrupt the Execution of Logic and Execute the Fault Handler

To interrupt the execution of logic and execute the fault handler, perform this procedure.

1. In the Controller Organizer of RSLogix 5000 programming software, right-click the module and select Properties.

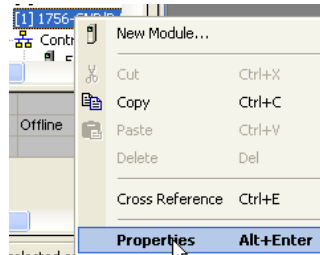

The Module Properties dialog appears.

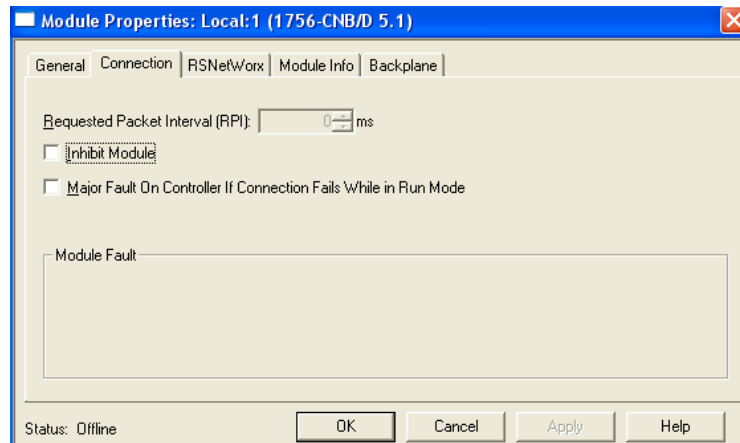

2. Click the Connection tab.
3. Select the Major Fault If Connection Fails While in Run Mode check box.
4. Develop a routine for the Controller Fault Handler.

Select a System Overhead Percentage

The Controller Properties dialog lets you specify a percentage for the system overhead, or time slice. The system overhead time slice specifies the percentage of controller time, excluding the time for periodic and event tasks, devoted to communication and background functions.

To select a system overhead percentage slice, perform this procedure.

1. In the Controller Organizer of RSLogix 5000 programming software, right-click the controller and select Properties.

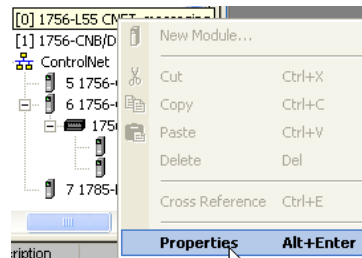

The Controller Properties dialog appears.

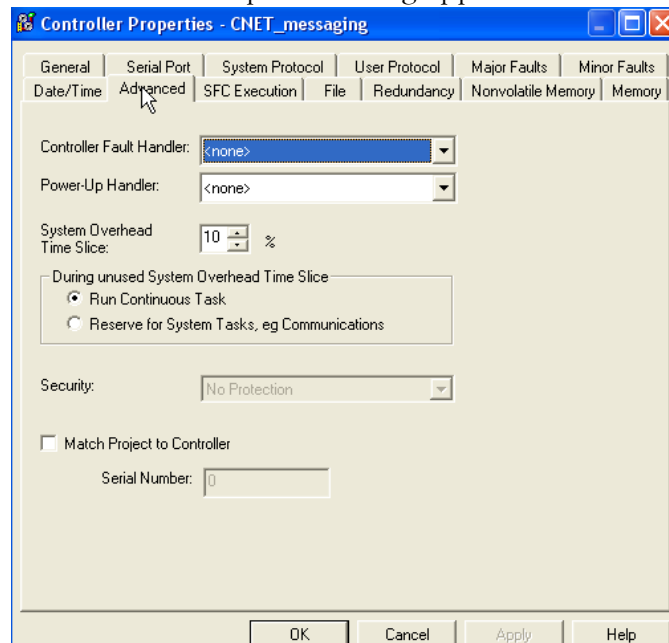

2. Click the Advanced tab.
3. Specify the system overhead settings.

System overhead functions include:

- communication with programming and HMI devices (such as RSLogix 5000 programming software).
- responding to messages.
- transmission of messages.

4. Click OK.

The controller performs system overhead functions for up to 1 ms at a time. If the controller completes the overhead functions in less than 1 ms, it resumes the continuous task.

As the system overhead percentage increases, time allocated to executing the continuous task decreases. If there is no communication for the controller to manage, the controller uses the communication time to execute the continuous task. While increasing the system overhead percentage does increase communication performance, it also increases the amount of time it takes to execute a continuous task, increasing overall scan time.

Ratio between the Continuous Task and System Overhead Functions

Time Slice	Continuous Task Length	Max Overhead Function Time
10%	9 ms	1 ms
20%	4 ms	1 ms
33%	2 ms	1 ms
50%	1 ms	1 ms

At a time slice of 10%, system overhead interrupts the continuous task every 9 ms (of continuous task time).

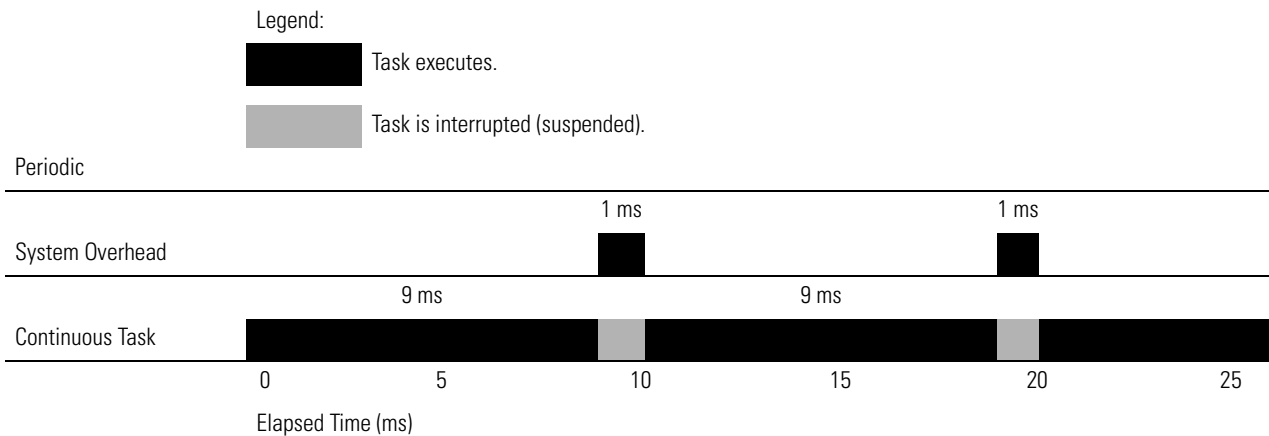

The interruption of a periodic task increases the elapsed time (clock time) between the execution of system overhead functions.

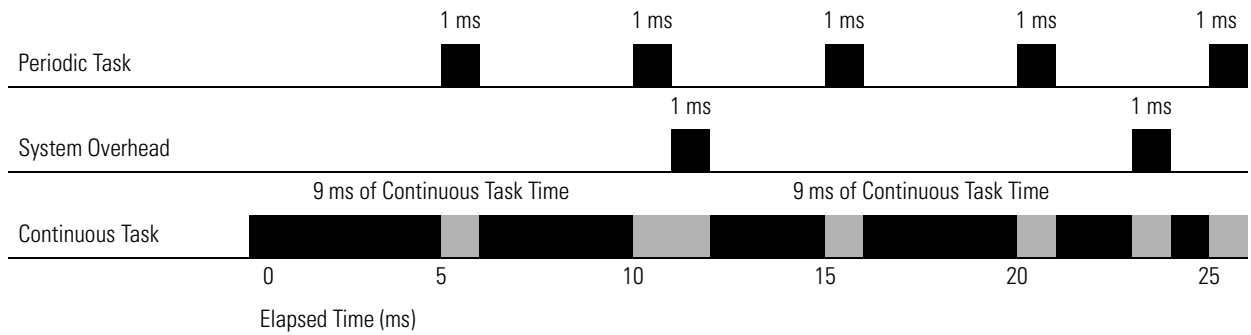

If you use the default time slice of 20%, the system overhead interrupts the continuous task every 4 ms.

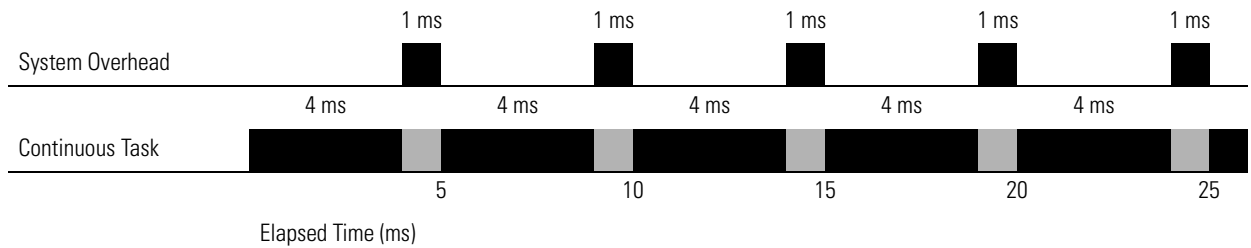

If you increase the time slice to 50%, the system overhead interrupts the continuous task every millisecond.

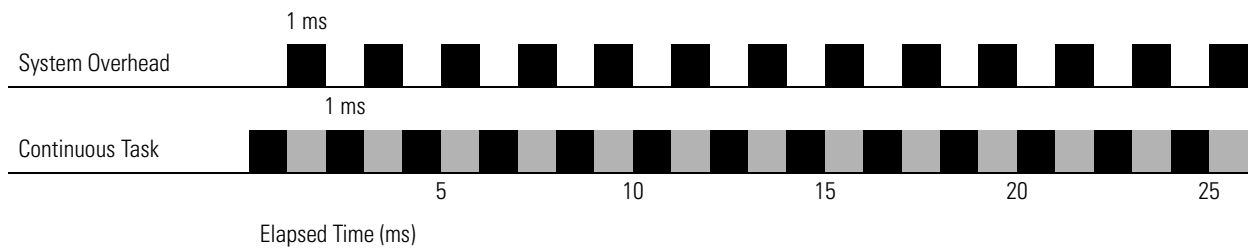

If the controller only contains periodic tasks, the system overhead time slice value has no effect. System overhead runs whenever a periodic task is not running.



Notes:

Configure PhaseManager

Introduction

This chapter explains how to configure PhaseManager.

Within RSLogix 5000 programming software, PhaseManager provides a state model for your equipment.

Topic	Page
PhaseManager Overview	83
State Model Overview	85
Compare PhaseManager to Other State Models	87
Minimum System Requirements	88
Equipment Phase Instructions	88

Additional Resources

For more information consult, PhaseManager User Manual, publication LOGIX-UM001.

PhaseManager Overview

PhaseManager lets you add equipment phases to your controller. An equipment phase helps you lay out your code in sections that are easier to write, find, follow, and change.

PhaseManager Terms

Term	Description
Equipment phase	<ul style="list-style-type: none"> As with a program, an equipment phase is run in a task and is given a set of routines and tags. Unlike a program, an equipment phase runs by a state model and lets you do one activity.
State model	<ul style="list-style-type: none"> A state model divides the operating cycle of your equipment into a series of states. Each state is an instant in the operation of the equipment, the actions, or conditions of the equipment at a given time. The state model of an equipment phase resembles that of the S88 and PackML state models.
State machine	<p>An equipment phase includes an embedded state machine that:</p> <ul style="list-style-type: none"> calls the main routine (state routine) for an acting state. manages the transitions between states with minimal coding. makes sure that the equipment goes from state to state along an allowable path.
PHASE tag	<p>When you add an equipment phase, RSLogix 5000 programming software makes a tag for the equipment phase. The tag uses the PHASE data type.</p>

PhaseManager Overview

A PHASE tag gives you the status of an equipment phase.

Name	Data Type
Add_Water	PHASE
Add_Water.State	DINT
Add_Water.Running	BOOL
Add_Water.Holding	BOOL
Add_Water.Restarting	BOOL

An equipment phase directs one activity of your equipment.
A state model divides the activity into a series of states.

Equipment phase instructions control the transitions between states and handle faults.

PSC POVR PCLF PRNP PATT
PCMD PFL PXRQ PPD PDET

Other code controls the specific actions of your equipment.

Water Feed

Conveyor

Enable Axes

State Model Overview

A state model defines what your equipment does under different conditions, such as run, hold, and stop.

PhaseManager States

State	Description
Acting	Does something or several things for a certain time or until certain conditions are met. An acting state runs once or repeatedly.
Waiting	Shows that certain conditions are met and the equipment is waiting for the signal to go to the next state.

PhaseManager State Transitions

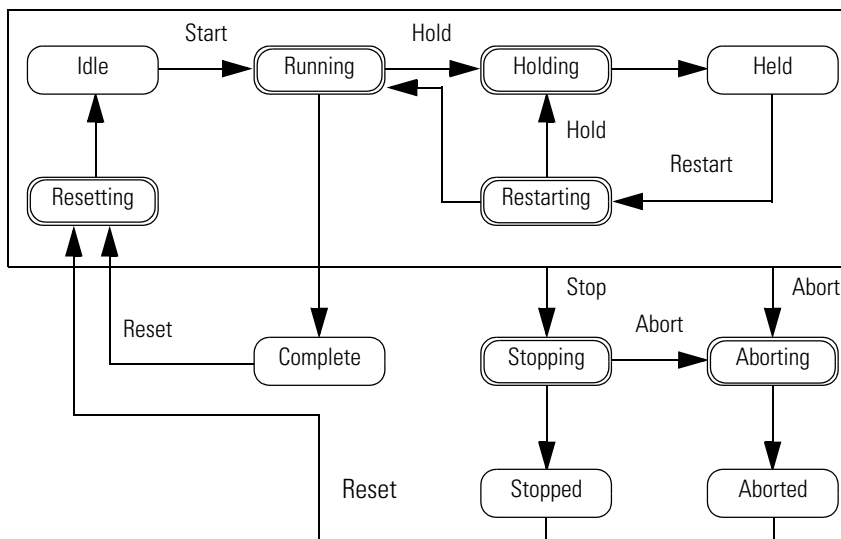

Your equipment can go from any state in the box to the stopping or aborting state.



Acting states represent the things your equipment does at a given time.

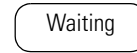

Waiting states represent the condition of your equipment when it is between acting states.

With a state model, you define the behavior of your equipment.

PhaseManager State Models

State	Question to be asked
Stopped	What happens when you turn on power?
Resetting	How does the equipment get ready to run?
Idle	How do you tell that the equipment is ready to run?
Running	What does the equipment do to make product?
Holding	How does the equipment temporarily stop making product without making scrap?
Held	How do you tell if the equipment is safely holding?
Restarting	How does the equipment resume production after holding?
Complete	How do you tell when the equipment is done with what it had to do?
Stopping	What happens during a normal shutdown?
Aborting	How does the equipment shut down if a fault or failure occurs?
Aborted	How do you tell if the equipment is safely shut down?

How Equipment Changes States

The state model's arrows show the states through which your equipment progresses.

- Each arrow is called a transition.
- A state model lets the equipment make only certain transitions. This restriction standardizes the equipment's behavior so that other equipment using the same model will behave the same way.

PhaseManager Transition Commands

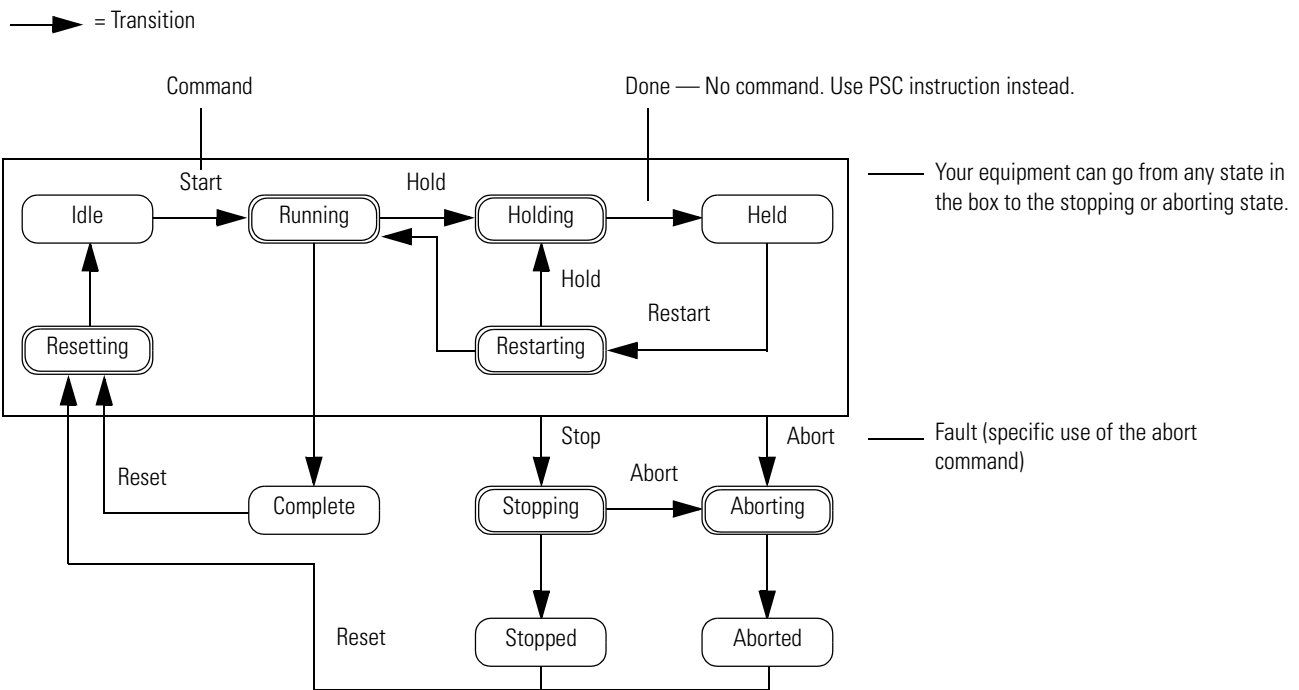

Type of Transition	Description						
Command	<p>A command tells the equipment to do something. For example, the operator pushes the start button to begin production and the stop button to halt production.</p> <p>PhaseManager uses these commands:</p> <table border="1"> <tr> <td>Reset</td> <td>Stop</td> <td>Restart</td> </tr> <tr> <td>Start</td> <td>Hold</td> <td>Abort</td> </tr> </table>	Reset	Stop	Restart	Start	Hold	Abort
Reset	Stop	Restart					
Start	Hold	Abort					
Done	Equipment goes to a waiting state when it is finished with what it is doing. You do not give the equipment a command. Instead, you set up your code to signal when the equipment is finished.						
Fault	A fault tells you that something out of the ordinary has happened. You set up your code to look for faults and take action if it finds any. If you want to shut down your equipment as quickly as possible when it detects a fault, set up your code to look for that fault and give the abort command if it finds it.						

Manually Change States

With RSLogix 5000 programming software, you can manually change an equipment phase.

To manually change a PhaseManager state, perform this procedure.

Current Equipment Phase

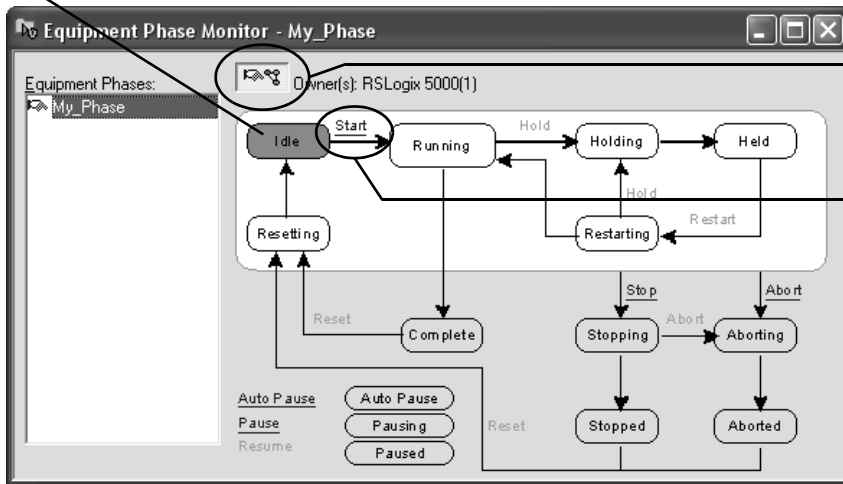

1. Take ownership of the equipment phase.

2. Give a command.

Compare PhaseManager to Other State Models

You can compare PhaseManager state models to other state models.

S88	PackML	PhaseManager
Idle	Starting ⇒ Ready	Reseting ⇒ Idle
Running ⇒ Complete	Producing	Running ⇒ Complete
Pausing ⇒ Paused	Standby	Subroutines or breakpoints
Holding ⇒ Held	Holding ⇒ Held	Holding ⇒ Held
Restarting	None	Restarting
Stopping ⇒ Stopped	Stopping ⇒ Stopped	Stopping ⇒ Stopped
Aborting ⇒ Aborted	Aborting ⇒ Aborted	Aborting ⇒ Aborted

Minimum System Requirements

To develop PhaseManager programs, you need:

- a ControlLogix controller, firmware revision 16.0 or later.
- a communication path to the controller.
- RSLogix 5000 software, version 16.0 or later.

To enable PhaseManager support, you need the full or professional editions of RSLogix 5000 programming software or RSLogix 5000 with PhaseManager software (9324-RLDPMENE).

Equipment Phase Instructions

The controller supports several equipment-phase ladder diagram (LD) and structured text (ST) instructions.

PhaseManager Instructions

Instruction	Instruction Function
PSC	Signal a phase that the state routine is complete and to proceed to the next state.
PCMD	Change the state or substate of a phase.
PFL	Signal a failure for a phase.
PCLF	Clear the failure code of a phase.
PXRQ	Initiate communication with RSBizWare Batch software.
PRNP	Clear the NewInputParameters bit of a phase.
PPD	Set up breakpoints within the logic of a phase.
PATT	Take ownership of a phase to either : <ul style="list-style-type: none"> • prevent another program or RSBizWare Batch software from commanding a phase. • make sure another program or RSBizWare Batch software does not already own a phase.
PDET	Relinquish ownership of a phase.
POVR	Override a command.

Develop Motion Applications

Introduction

This chapter explains how to configure a motion control program.

Topic	Page
Make the Controller the CST Master	90
Add the Motion Modules	91
Add SERCOS Interface Drives	93
Set Up Each SERCOS Interface Module	95
Add the Motion Group	97
Add Your Axes	100
Set Up Each Axis	101
Check the Wiring of Each Drive	104
Tune Each Axis	106
Obtain Axis Information	108
Program Motion Control	109

Overview of Motion Control Configuration

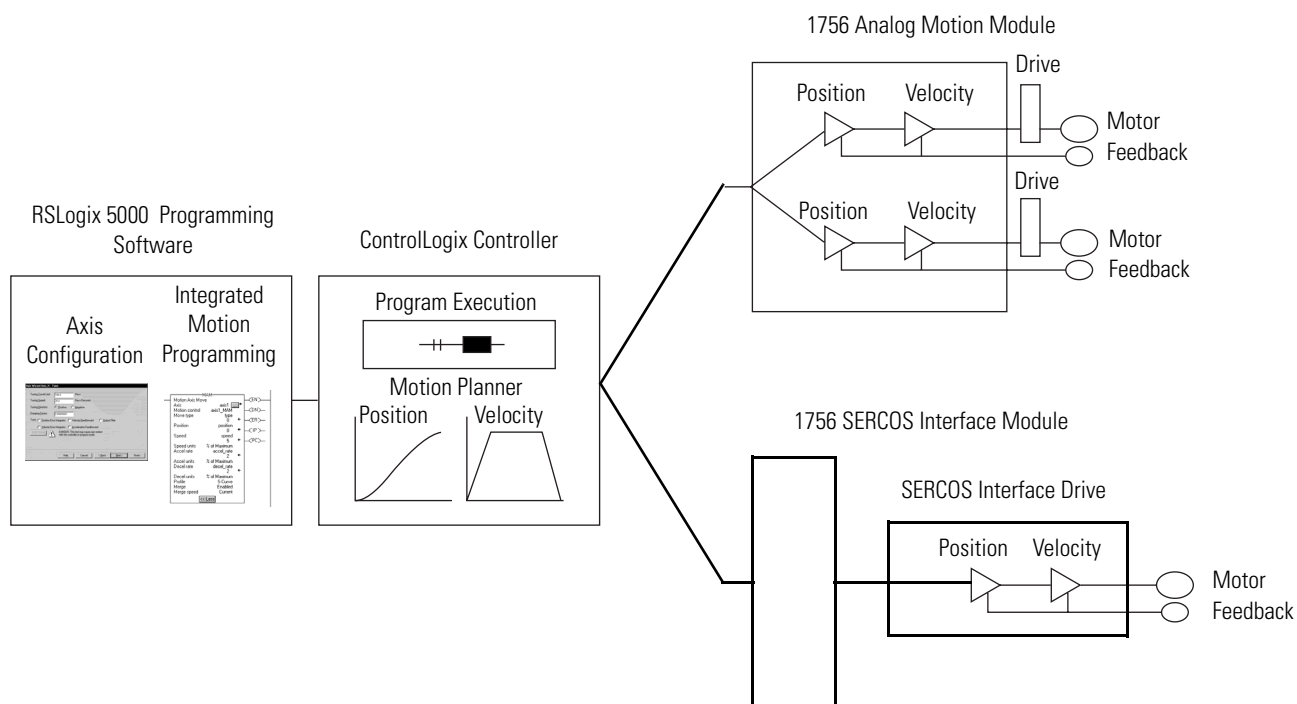

Make the Controller the CST Master

You must make one module in the chassis the master clock for motion control. This module is called the coordinated system time (CST) master. Motion modules set their clocks to the master.

In most cases, make the controller the CST master.

To make the controller the CST master, perform this procedure.

1. In RSLogix 5000 programming software, right-click the controller and select Properties.

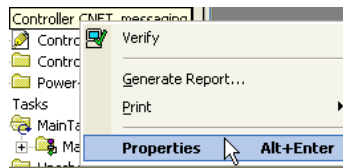

The Controller Properties dialog appears.

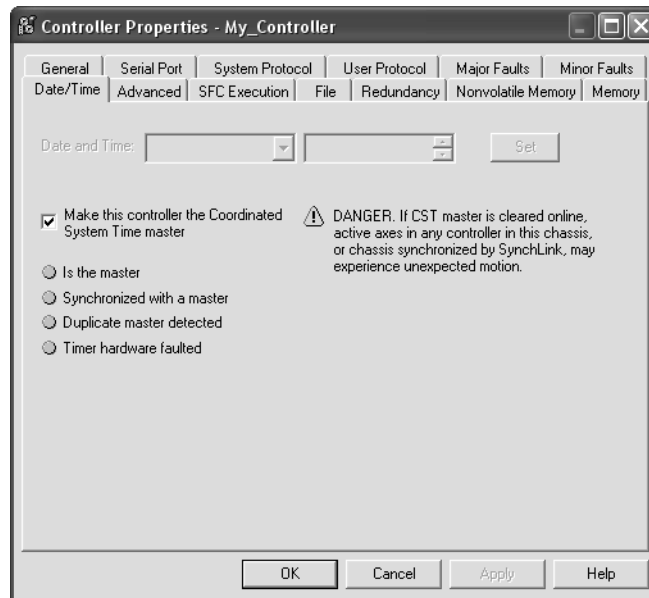

2. Click the Date/Time tab.
3. Select the Make this controller the Coordinated System Time master check box.
4. Click OK.

Multiple Controllers in the Chassis

If you have more than one controller in the chassis, designate one controller as the CST master. You cannot have more than one CST master for the chassis.

Add the Motion Modules

Each ControlLogix controller controls up to 16 motion modules.

IMPORTANT

For your motion modules, use the firmware revision that matches that of your controller. See the release notes for your controller's firmware revision.

Required Motion Modules

Used with Equipment	Feedback Type	Required Motion Module
Rockwell Automation SERCOS interface drives	⇒ ⇒ ⇒ ⇒	1756-M03SE (3 axes)
		1756-M08SE (8 axes)
		1756-M16SE (16 axes)
		1756-L60M03SE (3 axes)
Analog command signal	Quadrature feedback	1756-M02AE
	LDT feedback	1756-HYD02
	SSI feedback	1756-M02AS

To add motion modules, perform this procedure.

1. In the Controller Organizer of RSLogix 5000 programming software, right-click your module and select New Module.

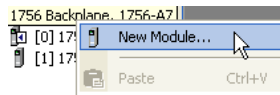

The Select Module dialog appears.

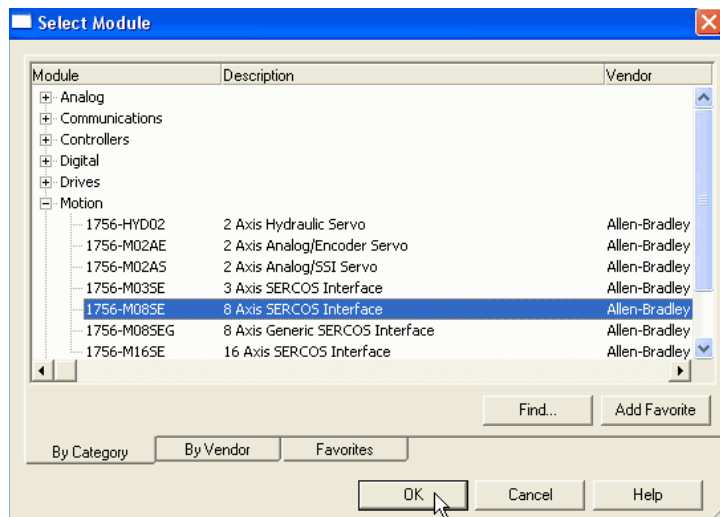

2. Double-click Motion.
3. Select the motion module you want to add.

4. Click OK.

The New Module dialog appears.

5. In the Name box, type the name of the new module
6. In the Slot box, enter the slot the new module will occupy.
7. Leave Open Module Properties unchecked.
8. Click OK.

Additional Information

For additional information, consult these publications:

- Motion Analyzer Selection Guide, publication PST-SG003
- ControlLogix Selection Guide, publication 1756-SG001

Add SERCOS Interface Drives

With the addition of SERCOS interface modules to a controller's I/O configuration, you can use RSLogix 5000 programming software to set up the modules.

To add SERCOS interface modules, perform this procedure.

1. In the I/O configuration tree in RSLogix 5000 programming software, right-click the SERCOS network and select New Module.

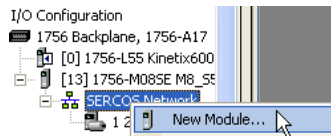

The Select Module dialog appears.

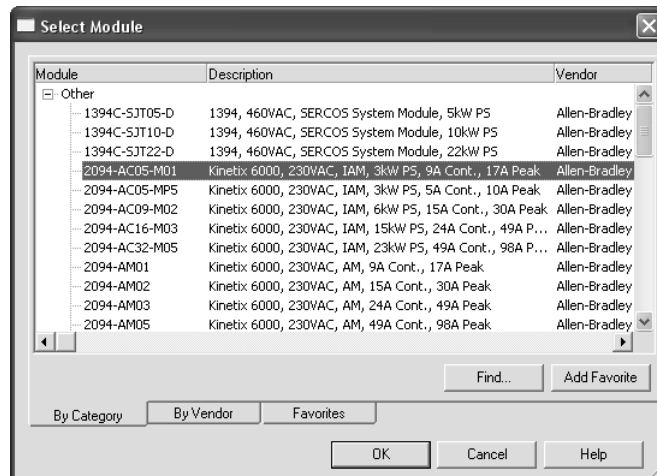

2. Double-click Other.
3. Select your drive.

Choose from these SERCOS interface drives:

- 1394
- Kinetix 6000
- Ultra3000
- 8720MC

4. Click OK.

The New Module dialog appears.

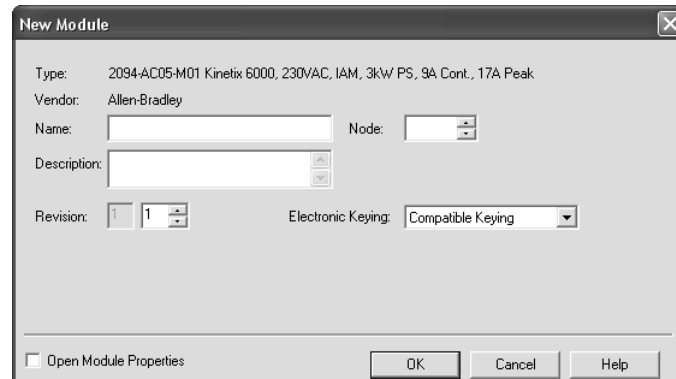

5. In the Name box, type the name of the new drive.
6. In the Node box, select the node number of the drive in the SERCOS ring.
7. Click OK.

Additional Resources

For additional information, consult these publications:

- Motion Analyzer Selection Guide, publication PST-SG003
- ControlLogix Selection Guide, publication 1756-SG001
- Logix5000 Motion Module User Manual, publication 1756-UM006

Set Up Each SERCOS Interface Module

To set the data rate and cycle time for each SERCOS interface module in your project, perform this procedure.

1. In the I/O configuration tree in RSLogix 5000 programming software, right-click your module and select Properties.

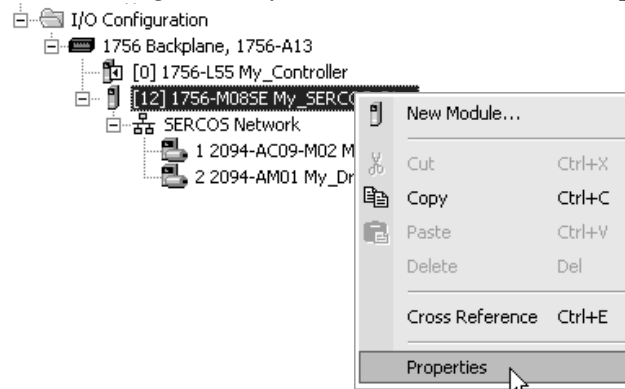

The Module Properties dialog appears.

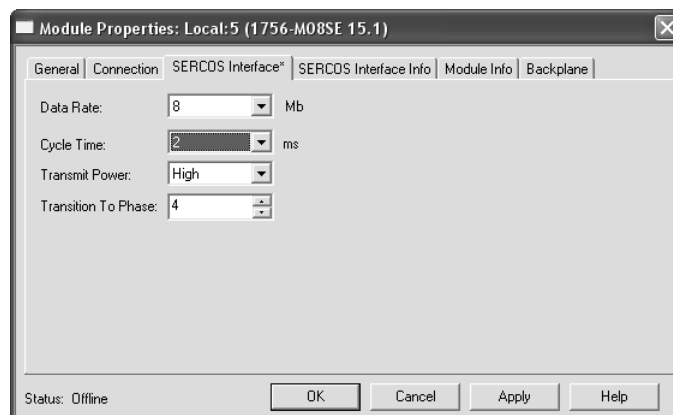

2. Click the SERCOS Interface tab.
3. From the Data Rate pull-down menu, choose Auto Detect.

4. From the Cycle Time pull-down menu, choose the cycle time.

Baud Rate of Drive	Number of Drives on Ring	Type of Drive	Cycle Time
4 MB	1 or 2	Kinetix 6000	0.5 ms
	3 or 4		1 ms
	5...8		2 ms
	9...16		Not possible. You must have 2 motion modules.
	1...4	Not Kinetix 6000	1 ms
	5...8		2 ms
	9...16		Not possible. You must have 2 motion modules.
8 MB	1...4	Kinetix 6000	0.5 ms
	5...8		1 ms
	9...16		2 ms
	1...8	Not Kinetix 6000	1 ms
	9...16		2 ms

5. Click OK.

Add the Motion Group

You can add a motion group to set up the motion planner.

Motion Planner	Part of the controller that takes care of position and velocity information for your axes
Coarse Update Period	How often the motion planner runs. When the motion planner runs, it interrupts all other tasks regardless of their priority.

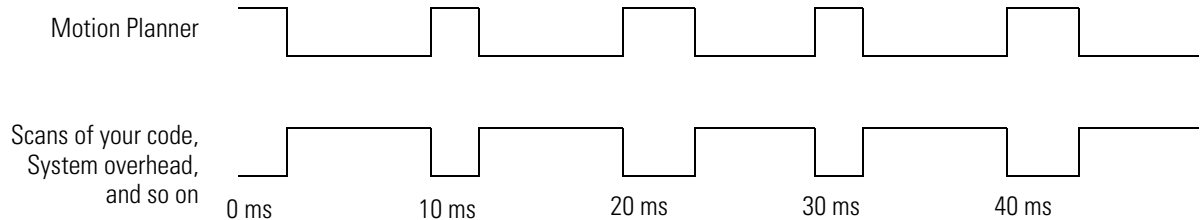

In this example, the coarse update period = 10 ms. Every 10 ms the controller stops scanning your code and whatever else it is doing and runs the motion planner.

IMPORTANT

Add only one motion group for the project. RSLogix 5000 software does not let you add more than one motion group.

To add a motion group to set up the motion planner, perform this procedure.

1. Choose your coarse update period.

IMPORTANT

The coarse update period is the interval between updating your axes' positions and scanning your code.

- a. Set the coarse update period to 10 ms.
- b. Leave at least half the controller's time for the scanning of all your code.
- c. Set the coarse update period to a multiple of the cycle time of the motion module.

Example: If the cycle time is 2 ms, set the coarse update period to 8 ms, 10 ms, 12 ms, and so on.

2. In RSLogix 5000 programming software, right-click Motion Groups and select New Motion Group.

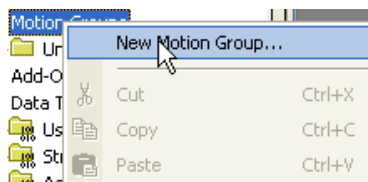

The New Tag dialog appears.

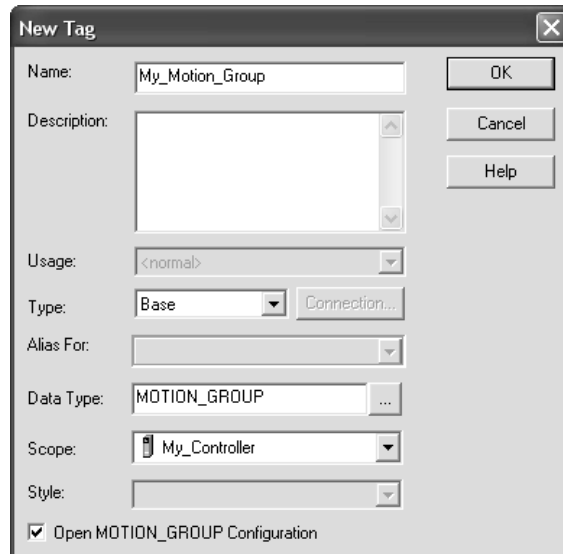

3. In the Name box, enter the tag name.
4. From the Data Type pull-down menu, choose MOTION_GROUP.
5. Click OK.

The Motion Group Wizard dialog appears.



6. Click Next.

The Motion Group Wizard Attributes dialog appears.

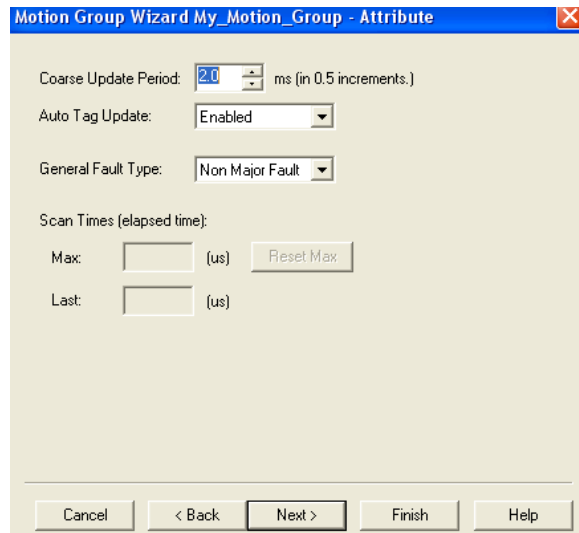

7. In the Coarse Update Period box, enter the intervals at which you want to run your motion planner.
8. Click Finish.

Add Your Axes

To add an axis for each of your drives, perform this procedure.

1. Decide which data type to use.

Motion Module	Data Type
<ul style="list-style-type: none"> • 1756-M03SE • 1756-M08SE • 1756-M16SE • 1756-L60M03SE 	AXIS_SERVO_DRIVE
1756-M08SEG	AXIS_GENERIC_DRIVE

2. In Motion Groups within RSLogix 5000 programming software, right-click My Motion Group and select New Axis and then the type of axis you want to add.

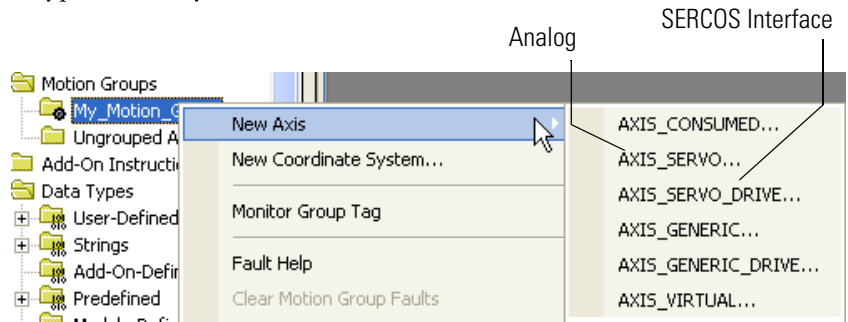

The New Tag dialog appears.

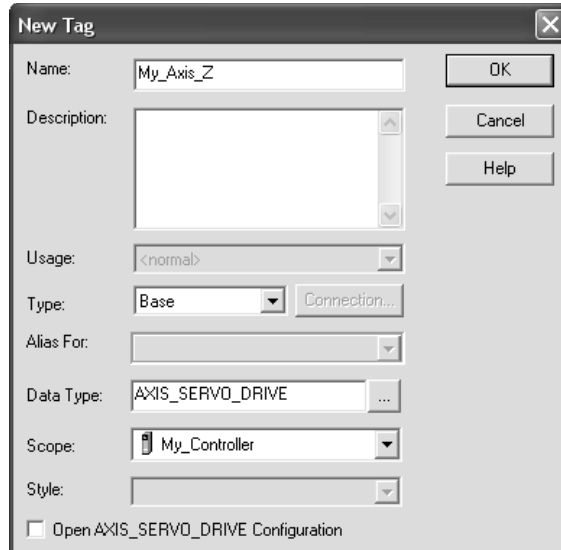

3. In the Name box, enter the name of your new axis.
4. Leave Open AXIS_SERVO_DRIVE Configuration unchecked.
5. Click OK.

Set Up Each Axis

To set up the axis of a SERCOS interface drive, perform this procedure.

1. In Motion Groups within RSLogix 5000 programming software, click motion_group, and then right-click an axis and select Properties.

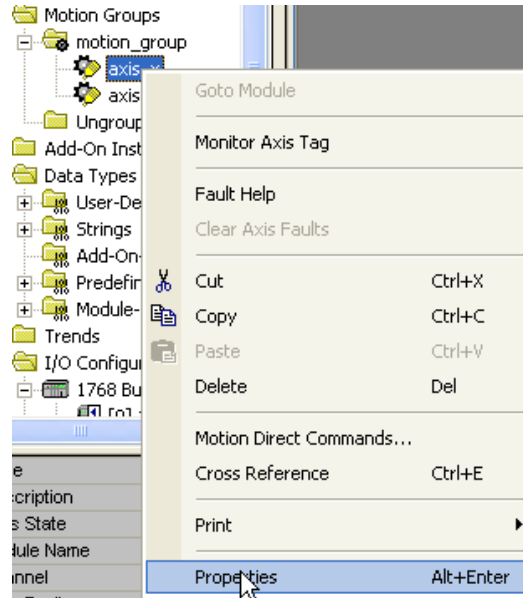

The Axis Properties Dialog appears.

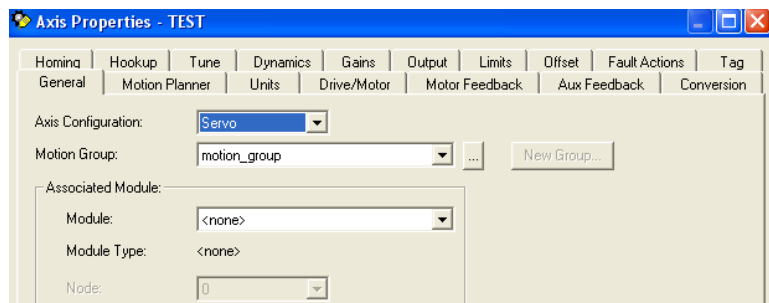

2. From the Module pull-down menu, choose the name that you gave to the drive for this axis.
3. Click the Units tab.

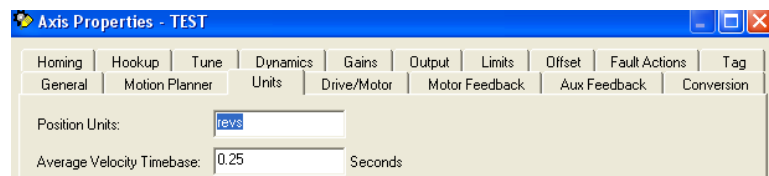

4. In the Position Units box, enter the units of measure, such as revolutions (revs), degrees, inches, or millimeters.

- Click the Drive/Motor tab.

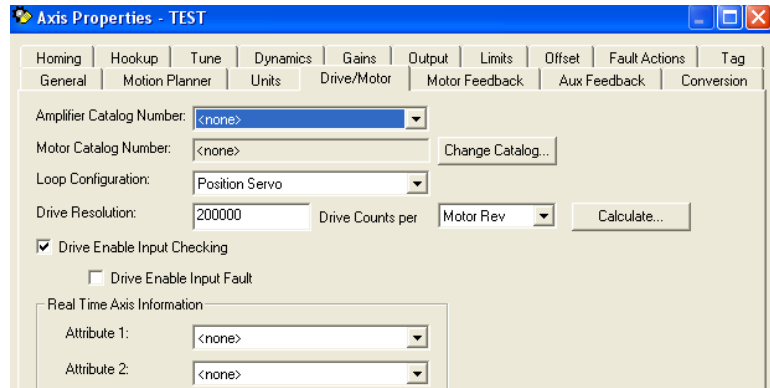

- From the Amplifier Catalog Number pull-down menu, choose the catalog number of your drive.
- To select your motor's catalog number, click Change Catalog.
- Click the Conversion tab.

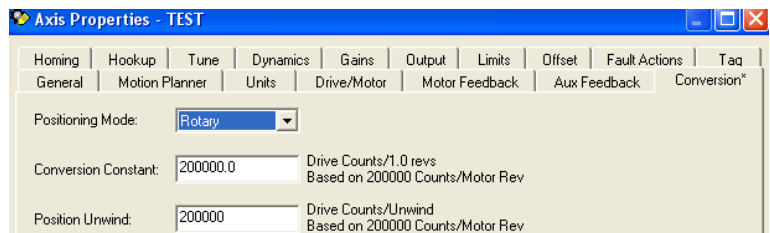

- From the Positioning Mode pull-down menu, choose rotary or linear.
- In the Conversion Constant box, type the number of drive counts per rotary or linear revolution.
- For a rotary axis only, in the Position Unwind box, type the number of feedback counts needed to automatically unwind the axis.

12. Click the Homing tab.

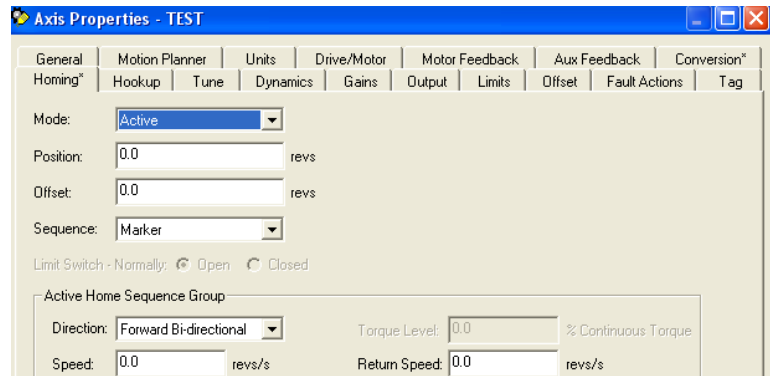

13. From the Sequence pull-down menu, choose one of these types of homing sequences:

- Immediate
- Switch
- Marker
- Switch-Marker

14. Within Active Home Sequence Group, in the Speed and Return Speed boxes, type the homing speeds.

15. Click OK.

Check the Wiring of Each Drive

Use these tests to check a drive's wiring.

Test	Function	Notes
Test marker	Verify that the encoder A, B, and Z channels are connected and phased properly for marker detection.	You must manually move the axis for this test.
Test feedback	Verify the polarity of the feedback.	You must manually move the axis for this test.
Test command and feedback	Verify the polarity of the drive.	

ATTENTION



These tests move the axis even with the controller in Remote Program mode.

- Before you do the tests, make sure no one is in the path of the axis.
- Do not change the polarity after you do the tests, or you may cause an axis-runaway condition.

To check the wiring of each drive, perform this procedure.

1. In Motion Groups within RSLogix 5000 programming software, click motion_group, and then right-click an axis and select Properties.

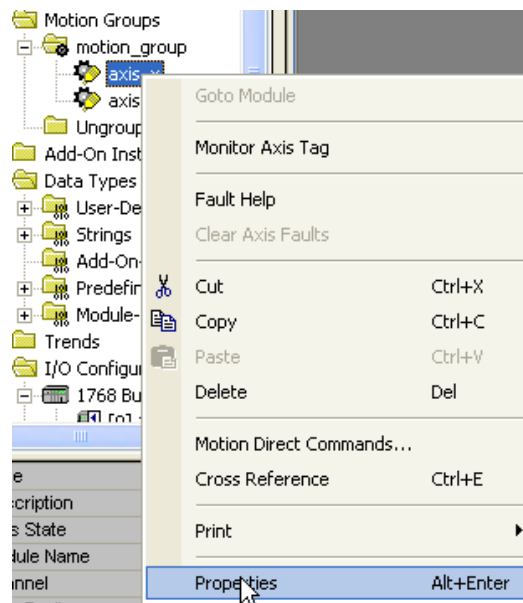

The Axis Properties Dialog appears.

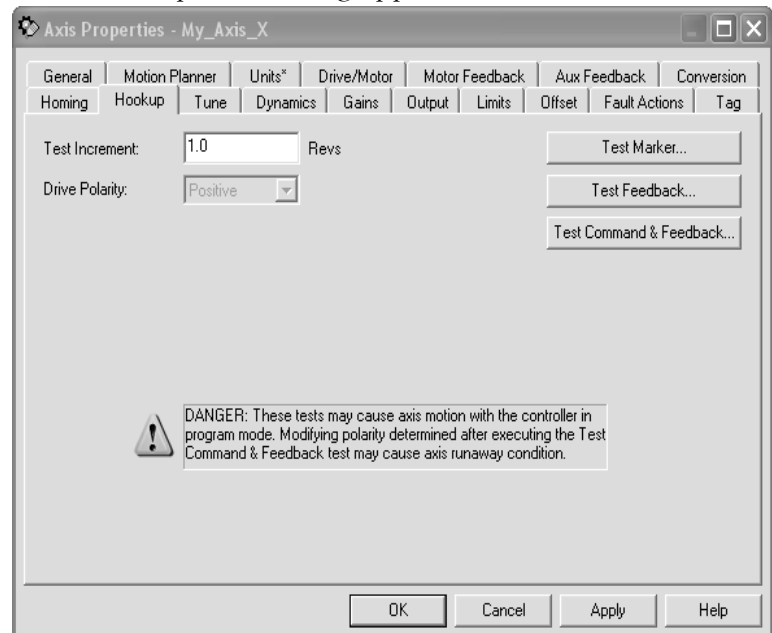

2. Click the Hookup tab.
3. In the Test Increment box, type the number of revolutions you want the axis to turn during each test.
4. Click Test Marker to check the channels for proper connection and phasing.
5. Click Test Feedback to test the polarity of the feedback.
6. Click Test Command & Feedback to test the drive's polarity.
7. Click OK.

Additional Resources

For additional information, consult the Logix5000 Motion Module User Manual, publication 1756-UM006.

Tune Each Axis

You need to tune each axis.

ATTENTION



When you tune an axis, it moves even with the controller in Remote Program mode. In that mode, your code is not in control of the axis.

Before you tune an axis, make sure no one is in its path.

To tune each axis, perform this procedure.

1. In Motion Groups within RSLogix 5000 programming software, click motion_group, and then right-click an axis and select Properties.

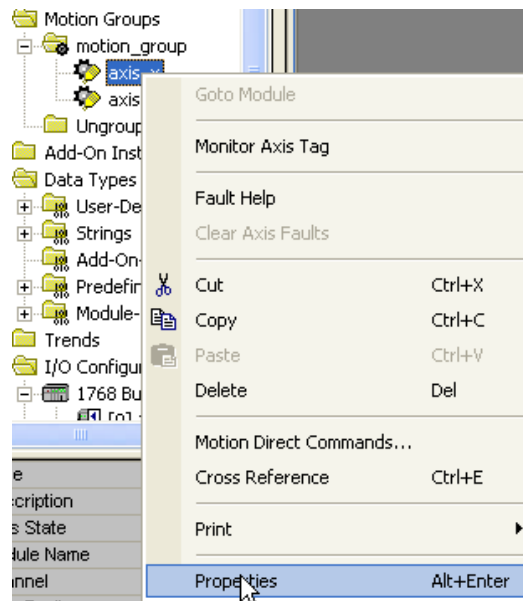

The Axis Properties dialog appears.

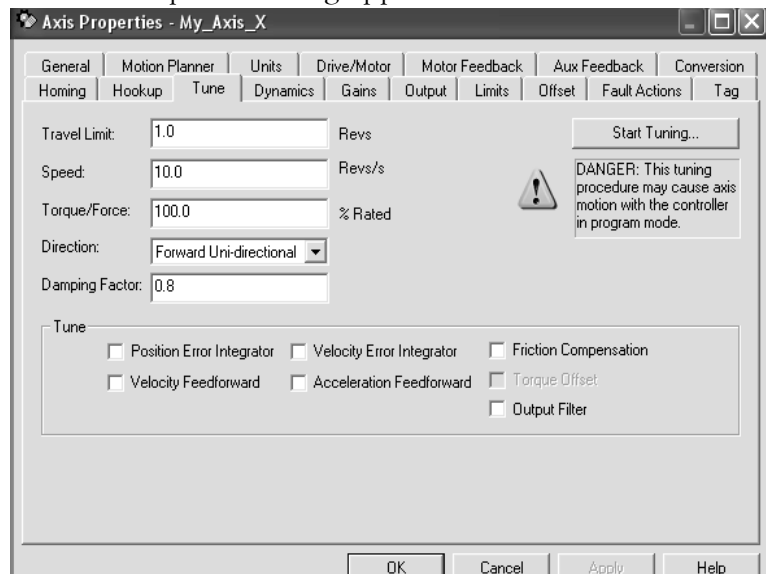

2. Click the Tune tab.
3. In the Travel Limit box, type the number of revolutions to which you want to limit your axis during its tuning.
4. In the Speed box, type the number of revolutions per second to which you want to limit your axis during its tuning.
5. Click Start Tuning.
6. Click OK.

Additional Resources

For additional information, consult the Logix5000 Motion Module User Manual, publication 1756-UM006.

Obtain Axis Information

You can obtain axis information through any one of several methods.

To obtain axis information, take any one, or all, of these steps.

Obtaining Axis Information

Use the Axis Properties dialog window to configure the axis.

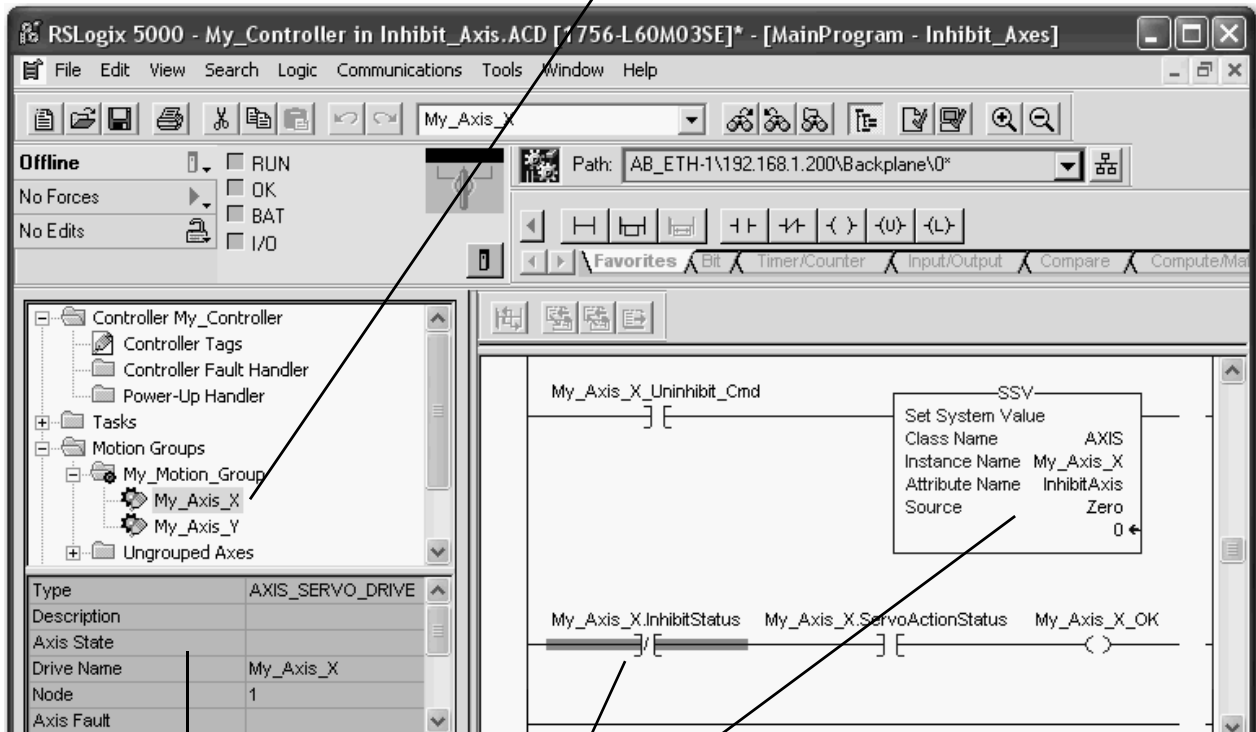

Use the Quick View pane to see the state and faults of an axis.

Use a Get System Value (GSV) instruction or Set System Value (SSV) instruction to read or change the configuration at run-time.

Use the tag of the axis for status and faults.

Program Motion Control

The controller gives you a set of motion control instructions for your axes and:

- uses these instructions just like the rest of the Logix5000 instructions.

You can program motion control in these programming languages:

- Ladder Diagram (LD)
- Structured Text (ST)
- Sequential Function Chart (SFC)
- each motion instruction works on one or more axes.
- each motion instruction needs a motion control tag. The tag uses a MOTION_INSTRUCTION data type and stores the instruction's information status.

Motion Control Instruction

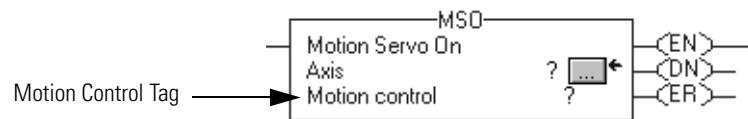

ATTENTION



Use the tag for the motion control operand of motion instruction only once. Unintended operation of the control variables may happen if you reuse of the same motion control tag in other instructions.

Example

Here's an example of a simple ladder diagram that homes, jogs, and moves an axis.

If Initialize_Pushbutton = on and the axis = off (My_Axis_X.ServoActionStatus = off) then

The MSO instruction turns on the axis.



If Home_Pushbutton = on and the axis hasn't been homed (My_Axis_X.AxisHomedStatus = off) then

The MAH instruction homes the axis.

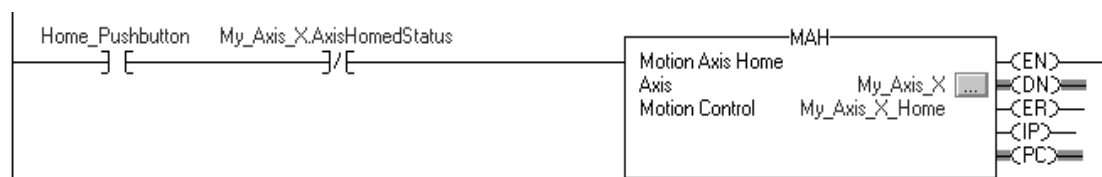

If Jog_Pushbutton = on and the axis = on (My_Axis_X.ServoActionStatus = on) then

The MAJ instruction jogs the axis forward at 8 units/second.

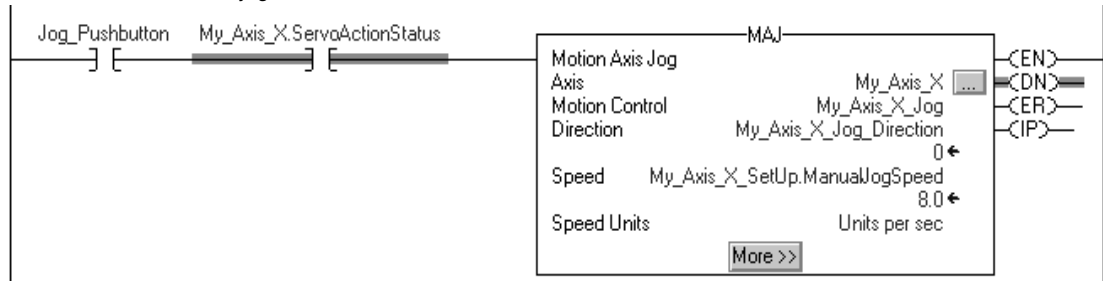

If Jog_Pushbutton = off then

The MAS instruction stops the axis at 100 units/second²

Make sure that Change Decel is Yes. Otherwise, the axis decelerates at its maximum speed.

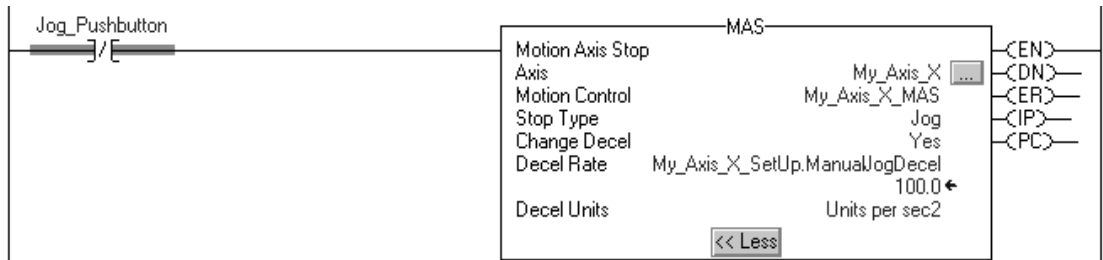

If Move_Command = on and the axis = on (My_Axis_X.ServoActionStatus = on) then

The MAM instruction moves the axis. The axis moves to the position of 10 units at 1 unit/second.

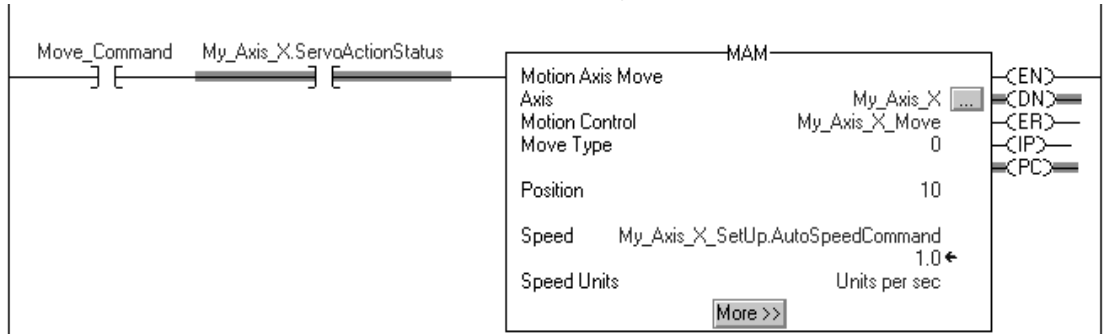

Additional Resources

For additional information, consult these publications:

- Logix5000 Controllers Common Procedures Programming Manual, publication 1756-PM001
- Logix5000 Controllers Motion Instructions Reference Manual, publication 1756-RM007
- Logix5000 Controllers General Instructions Reference Manual, publication 1756-RM003

Configure Redundancy

Introduction

This chapter explains how the ControlLogix redundancy system uses an identical pair of ControlLogix chassis to keep your machine or process running if a problem occurs with any equipment in a redundant chassis.

Topic	Page
ControlLogix Redundancy Overview	111
Build a Redundant System	113
ControlNet Considerations in Redundant Systems	114
EtherNet/IP Considerations in Redundant Systems	115
Redundancy and Scan Time	116
Minimum System Requirements	116

Additional Resources

For additional information consult the ControlLogix Redundancy System User Manual, publication 1756-UM523.

ControlLogix Redundancy Overview

Redundancy provides for higher system availability by switching control to a secondary controller chassis if anything in the primary controller chassis fails. The redundant system switches from primary to secondary due to:

- power loss to primary chassis.
- hardware or firmware failure of any module in the primary chassis.
- a major fault in the user program on the primary controller.
- disconnection of a ControlNet tap or ControlNet cable to a 1756-CNB module in the primary chassis.
- disconnection of an Ethernet patch cable from a 1756-ENBT or 1756-EWEB module in the primary chassis.
- removal of any module in the primary chassis.
- a user command that causes a switchover.

ControlLogix Redundancy System Overview

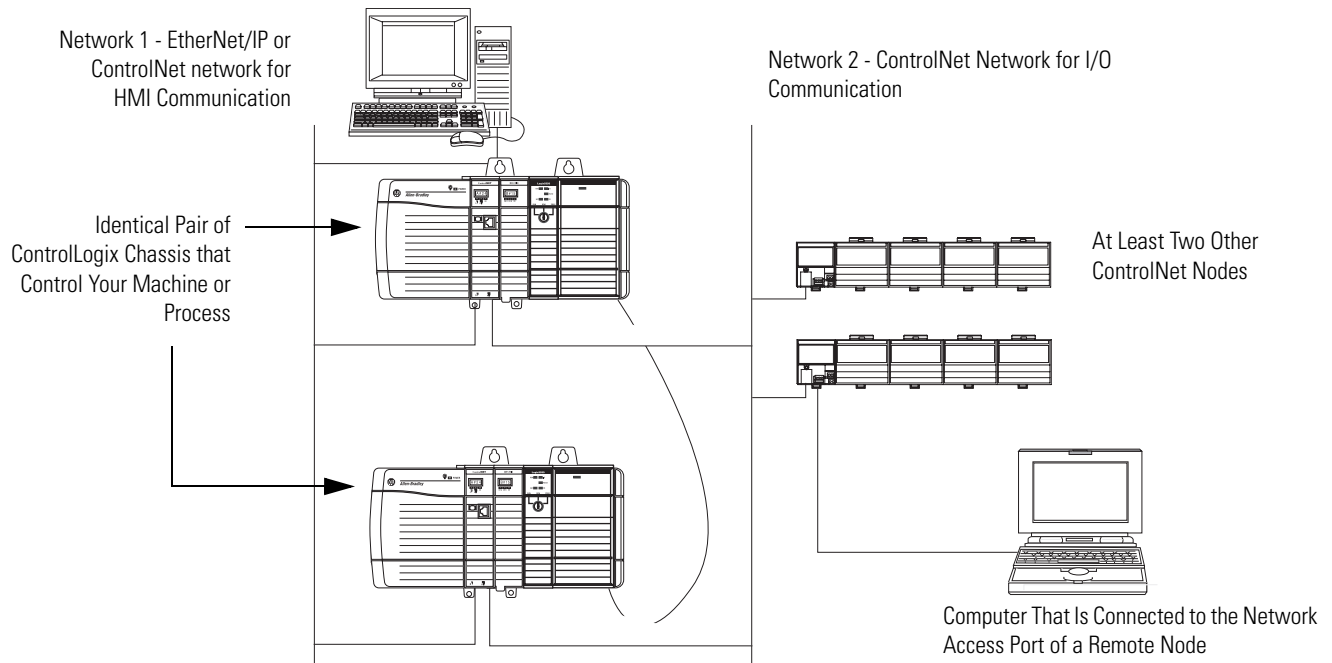

Redundancy requires no additional programming and is transparent to any devices connected over an EtherNet/IP or ControlNet network. It uses 1757-SRM modules to maintain communication between the pair of redundant chassis.

Depending on how you organize your RSLogix 5000 project, outputs may or may not experience a change in state (bump) during a switchover.

- During the switchover, outputs that are controlled by the highest priority task will experience a bumpless switchover. For example, outputs will not revert to a previous state.
- Outputs in lower priority tasks may experience a change of state.

The switchover time of a redundant system depends on the type of failure and the network update time (NUT) of the ControlNet network. For a NUT of 10 ms, the switchover time is approximately 80...220 ms.

Build a Redundant System

To build a typical redundant system, perform this procedure.

1. Start with any ControlLogix chassis.
2. Add a 1756-L55, 1756-L61, 1756-L62, 1756-L63, or 1756-L64 controller.
3. Add one or more ControlNet (1756-CNB, 1756-CNBR) or EtherNet/IP (1756-ENBT) communication modules.
4. Add one 1757-SRM redundancy module.
5. Set up a second chassis that is identical to the first chassis.
6. Connect the 1757-SRM redundancy modules in both chassis.
7. Add I/O modules, operator interfaces, and other devices to the ControlNet network.

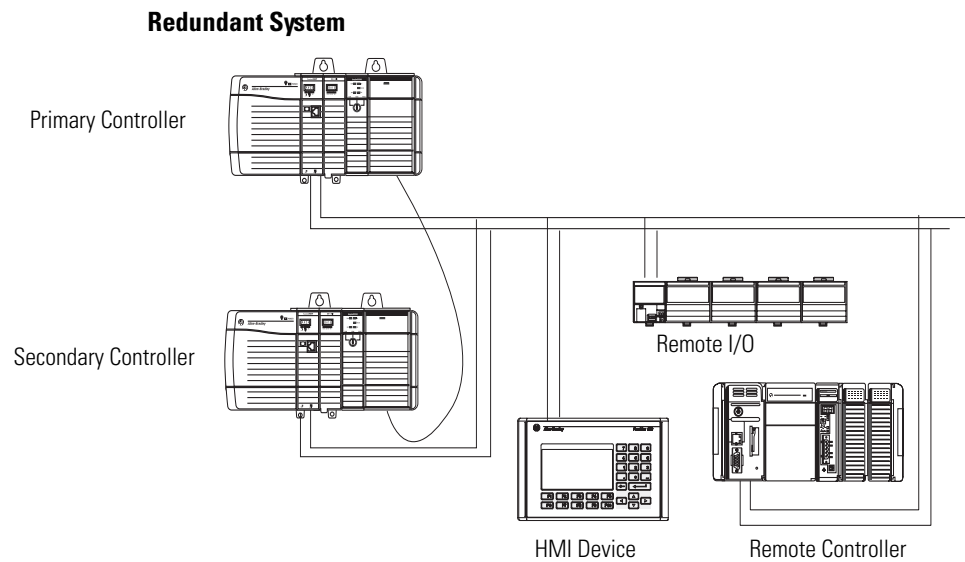

System Considerations

Items in Primary and Secondary Chassis	Consideration
ControlLogix controller	<p>As of firmware revision 13, you can use these combinations of ControlLogix controllers in a redundant chassis:</p> <ul style="list-style-type: none"> • one 1756-L55 controller • two 1756-L55 controllers • one 1756-L6x controller <p>When configured for redundancy, the secondary controller automatically receives and buffers data.</p> <p>A redundant controller uses twice as much data memory and I/O memory space as a nonredundant controller</p> <p>The controllers synchronize data transfers to support a bumpless switchover.</p> <ul style="list-style-type: none"> • A redundant controller has a significantly longer scan time than a nonredundant controller • The scan time can affect high-speed processes requiring fast (<50 ms) program scans. • Minimize the scan time impact by packing data into arrays and structures so the data transfer from primary to secondary controller is more efficient <p>You do not need a special version of RSLogix 5000 software for redundancy</p>
Communication modules	<ul style="list-style-type: none"> • Only controllers, 1756-CNB and 1756-CNBR modules, 1756-ENBT modules, and one 1757-SRM redundancy module can reside in a redundant controller chassis • As many as two EtherNet/IP modules can reside in a redundant chassis. • As many as five communication modules can reside in a redundant chassis, such as two EtherNet/IP modules and three ControlNet modules. • To connect to other networks, bridge through another ControlLogix chassis. • Use a separate network for HMI and I/O communication.
I/O modules	All I/O is remote from the redundant controller chassis.
Redundant power supplies	The 1756-PA75R and 1756-PB75R redundant power supplies provide reliable chassis power.

ControlNet Considerations in Redundant Systems

You can have as many as five ControlNet communication modules in a redundant chassis. You can use 1756-CNB and 1756-CNBR ControlNet Modules.

You must have at least two ControlNet nodes external to the redundant controller chassis to avoid timeouts on switchover.

The lowest ControlNet node must be outside the redundant controller chassis.

EtherNet/IP Considerations in Redundant Systems

You can have as many as two EtherNet/IP modules in the redundant chassis. You can use 1756-ENBT EtherNet/IP and 1756-EWEB EtherNet/IP Web Server modules.

In a redundant system, use EtherNet/IP for HMI communication or inter-controller messaging only. HMI can talk directly to the primary controller. You no longer need RSLinx Alias Topics. Redundancy does not support EtherNet/IP for I/O control or producing and consuming data.

IP Address Swapping

Firmware version 13 supports IP address swapping in redundant systems. Configure the primary and secondary EtherNet/IP modules with the same IP address. The primary EtherNet/IP module takes the IP address; the secondary module takes that address plus one in the last address segment.

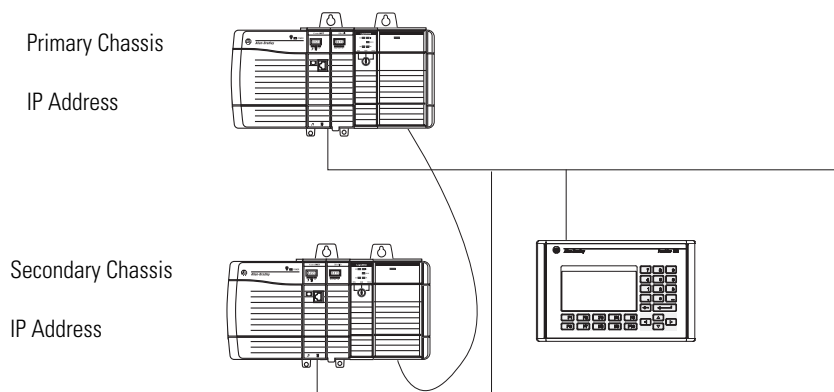

On switchover, the EtherNet/IP modules swap IP addresses. HMI devices automatically continue to communicate with the primary controller. Because of the way EtherNet/IP modules work, during a switchover, communication between the controller and an HMI device halts for several seconds, typically less than a minute, while the IP address propagates.

Use a dedicated ControlNet network instead of an EtherNet/IP network if you need a bumpless HMI connection.

Redundancy and Scan Time

The primary controller stops at the end of every program to crossload fresh data to the secondary controller. This keeps the secondary controller up-to-date and ready to take over. It also increases the scan time when compared to a nonredundant system.

The amount of time a crossload consumes depends on how much data the primary controller has to crossload:

- The primary controller crossloads any tag to which an instruction wrote a value, even the same value, since the last crossload.
- Crossloading also requires a small amount of overhead time to tell the secondary controller which program the primary controller is executing.

Minimum System Requirements

At a minimum, a ControlLogix redundancy system must contain these items.

Quantity	Item	Notes
2	ControlLogix chassis	Both chassis must be the same size.
2	ControlLogix power supply	
2	ControlLogix controller	<ul style="list-style-type: none"> • Use either 1756-L55, 1756-L61, 1756-L62, 1756-L63, or 1756-L64 controllers. • Use the same catalog number and memory size controllers in each chassis.
2	ControlLogix ControlNet communication module	Use series D modules.
2	ControlLogix 10/100 Mbps Ethernet/IP communication module	<ul style="list-style-type: none"> • Optional • You can use a second pair of 1756 ControlNet communication modules for HMI/workstation communication.
2	1757 system redundancy module	
1	1757 system redundancy cable	Standard lengths are available.
2	Additional ControlNet nodes	<ul style="list-style-type: none"> • Place all I/O in remote chassis or din rails. • Use a ControlNet network for all I/O. • Add at least 2 nodes to each ControlNet network in addition to the redundant chassis pair.

SIL 2 Certification

Introduction

This chapter explains how ControlLogix system components are type-approved and certified for use in SIL 2 applications, according to IEC 61508 and AK4 applications in line with DIN V19250. SIL requirements are based on the standards current at the time of certification.

Topic	Page
SIL 2 Overview	117
SIL 2 Application	118

IMPORTANT

For a list of ControlLogix system components that meet SIL 2 requirements, see Using ControlLogix in Sil 2 Applications Reference Manual, publication 1765-RM001

SIL 2 Overview

A Safety Integration Level (SIL) is a numeric designator assigned to a safety system that indicates that system's ability to perform its safety function. The SIL 2 TYPE certification of ControlLogix products by TUV, an internationally recognized and accredited test laboratory certification center, assures the suitability of ControlLogix products for use in up to a SIL 2 safety application. TUV certification is based primarily on compliance with IEC 61508 Functional Safety of Electrical/Electronic/Programmable Electronic Safety-Related Systems requirements. It also includes a number of application-independent standards, DIN V 19250 and VDE 0801, application-dependent standards, prEN 50156 for ESD applications, DIN EN 54 for fire and gas application, and environmental and electrical safety standards, IEC 61131-2, EN 50178, EN 50081-2, and EN 61000-2:2000.

These requirements consist of mean time between failures (MTBF), probability of failure, failure rates, diagnostic coverage and safe failure fractions that fulfill SIL 2 criteria. The results make the ControlLogix system suitable up to, and including, SIL 2. When the ControlLogix system is in maintenance or programming mode, the user is responsible for maintaining a safe state.

For support in the creation of programs, the PADT (Programming and Debugging Tool) is required. The PADT for ControlLogix is RSLogix 5000 programming software, per IEC 61131-3, and this Safety Reference Manual.

SIL 2 Application

In obtaining SIL 2 certification for a ControlLogix system, Rockwell Automation did not need to create a special line of products to meet stringent SIL 2 requirements. Sophisticated diagnostics and high levels of reliability are standard in ControlLogix processors, I/O modules, and communication products. It is that same standard design that readily provides the reliability needed to achieve SIL 2 certification.

A typical ControlLogix SIL loop includes:

- the overall safety loop.
- the ControlLogix portion of the safety loop.
- how other devices (for example, HMI) connect to the loop, while operating outside the loop.

SIL 2 Application Overview

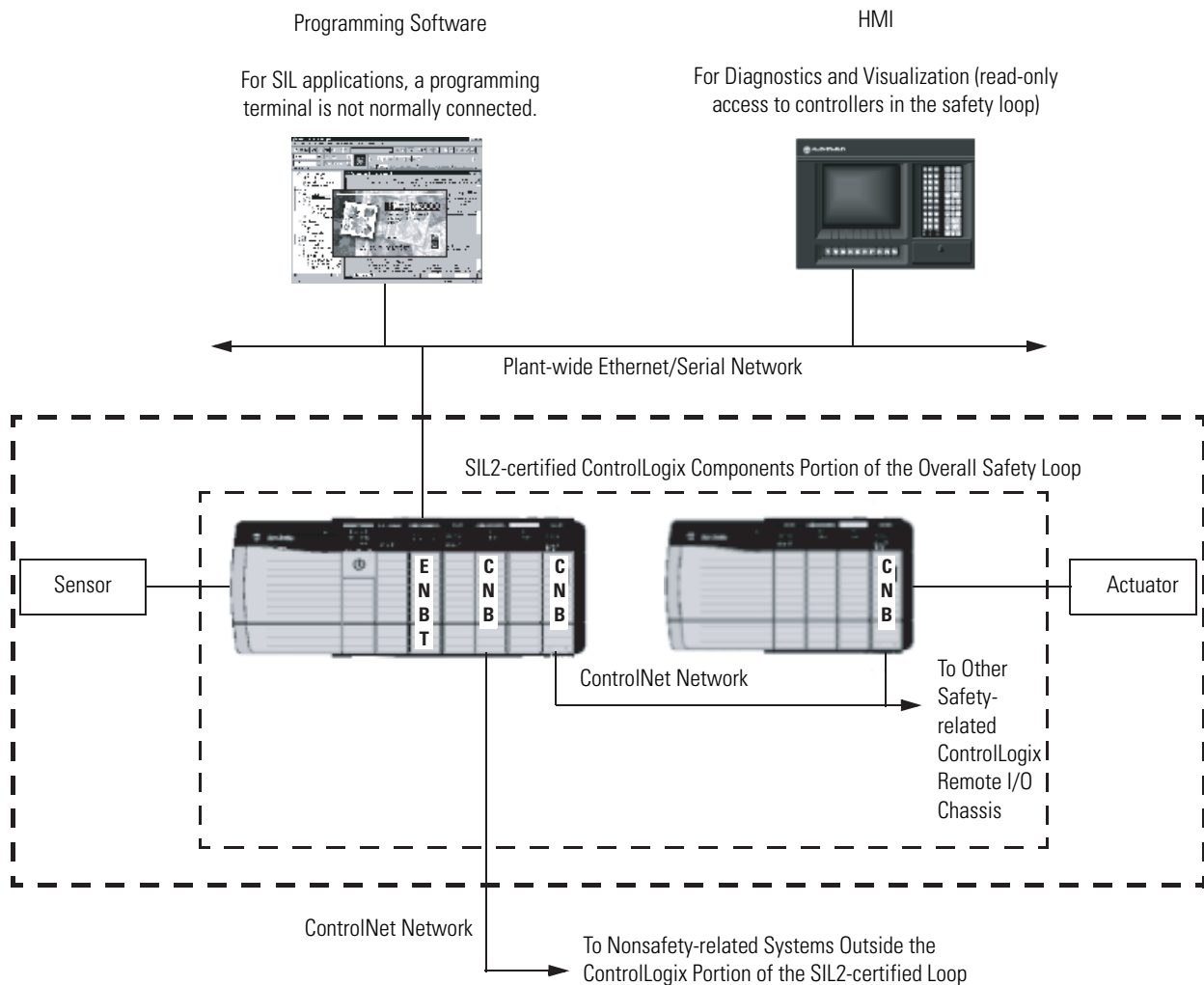

Maintain Nonvolatile Memory

Introduction

This chapter explains how to maintain nonvolatile memory.

The 1756-L6x controllers support the 1784-CF64 CompactFlash card for nonvolatile memory. The 1756-L55M22, 1756-M23, and 1756-M24 controllers have built-in nonvolatile memory.

Nonvolatile memory lets you keep a copy of your project on the controller. The controller does not need power to keep this copy.

You can load the copy from nonvolatile memory to the controller's user memory:

- each time you apply power.
- whenever there is no project in the controller and you apply power.
- at any time via RSLogix 5000 programming software.

Topic	Page
Choose a Controller That Has Nonvolatile Memory	120
Use a CompactFlash Reader	121

IMPORTANT

Nonvolatile memory stores the contents of the user memory when you store the project.

- Changes made after storing a project are not reflected in nonvolatile memory.
 - If you change to the project but do not store those changes, you overwrite them when you load the project from nonvolatile memory. If this occurs, you have to upload or download the project to go online.
 - If you want to store changes such as online edits, tag values, or a ControlNet network schedule, store the project again after you make the changes.
-

Choose a Controller That Has Nonvolatile Memory

These ControlLogix controllers have nonvolatile memory.

ControlLogix Controllers and Nonvolatile Memory

Controller	Cat. Number	Firmware Revision	Requires a 1784-CF64 Industrial CompactFlash memory card
ControlLogix5555	1756-L55M22	10.x or later	No
	1756-L55M23	8.x or later	No
	1756-L55M24	8.x or later	No
ControlLogix5560M03SE	1756-L60M03SE	13.x or later	Yes
ControlLogix5561	1756-L61	12.x or later	Yes
ControlLogix5562	1756-L62	12.x or later	Yes
ControlLogix5563	1756-L63	11.x or later	Yes
ControlLogix5564	1756-L64	16 or later	Yes

Prevent a Major Fault During a Load

If the major and minor revisions of the project in nonvolatile memory do not match the major and minor revisions of the controller, a major fault may occur during a load.

Controller	Consequences
Does not use a CompactFlash card	<p>Make sure that the major and minor revisions of the project in nonvolatile memory match the major and minor revisions of the controller.</p> <p>The nonvolatile memory of the controller stores only the project. It does not store the firmware for the controller.</p>
Uses a CompactFlash card	<p>The CompactFlash card stores the firmware for projects ≥ 12.0. Depending on the current revision of the controller, you may be able to use the CompactFlash card to update the firmware of the controller and load the project.</p>

Use a CompactFlash Reader

If the revision of the project or projects on your CompactFlash card are ≥ 12 , then the card is formatted using the FAT16 file system.

You do not have to manage the files on a CompactFlash card. The card automatically loads the project that you most recently stored. For additional flexibility, the file system also lets you:

- manually change which project loads from the CompactFlash card.
- manually change the load parameters for a project.

A sample controller project that reads and writes a CompactFlash card is available with RSLogix 5000 Enterprise programming software. See the section Sample Controller Projects on pg. 71.

Additional Resources

For additional information, consult the Logix5000 Controllers Common Procedures Programming Manual, 1756-PM001

Notes:

Maintain the Battery

Introduction

This chapter explains how to maintain the batteries supported by ControlLogix controllers.

Controller	Series	Supported Battery
ControlLogix5550 ControlLogix5555 ControlLogix5560M03SE	⇒	1756-BA1
ControlLogix5561 ControlLogix5562 ControlLogix5563	A	1756-BA1
ControlLogix5561 ControlLogix5562 ControlLogix5563 ControlLogix5564	B	1756-BA2

Topic	Page
Check If the Battery Is Low	124
Estimate 1756-BA1 Battery Life	124
Estimate 1756-BA2 Battery Life (1756-L6x series B controllers only)	126
Maintain a 1756-BATM Battery Module	128
Store Batteries	129

Check If the Battery Is Low

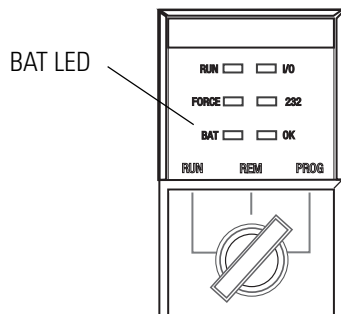

When the battery is about 95% discharged, the controller gives these low-battery warnings:

- Solid red BAT LED.
- Minor fault (type 10, code 10).

ATTENTION



To prevent possible battery leakage, even if the BAT LED is off, replace a battery according to this schedule.

If the temperature 2.54 cm. (1 in.) below the chassis is	Replace the battery within
0...35 °C (32...95 °F)	3 years
36...40 °C (96.8...104 °F)	3 years
41...45 °C (105.8...113 °F)	2 years
46...50 °C (114.8...122 °F)	16 months
51...55 °C (123.8...131 °F)	11 months
56...60 °C (132.8...140 °F)	8 months

Estimate 1756-BA1 Battery Life

To estimate how long a 1756-BA1 battery will support controller memory on 1756-L55Mx (all series) and 1756-L6x, series A controllers, perform this procedure.

1. Determine the temperature 2.54 cm. (1 in.) below the chassis.
2. Determine the weekly percentage of time that the controller is turned on.

EXAMPLE

If a controller is off **either**:

- 8 hr/day during a 5-day work week.
- all day Saturday and Sunday.

Then the controller is off 52% of the time:

- Total hours per week = 7 x 24 = 168 hours
- Total off hours per week = (5 days x 8 hr/day) + Saturday + Sunday = 88 hours
- Percentage off time = 88/168 = 52%

3. Determine the estimated worst-case battery life before and after the BAT LED turns on.
4. For each year of battery life, decrease the time before the BAT LED turns on by the percentage that is shown in the table.

Do not decrease the time after the BAT LED turns on.

IMPORTANT

If the BAT LED turns on when you apply power to the controller, the remaining battery life may be less than this table indicates. Some of the battery life may have been used up while the controller was off and unable to turn on the BAT LED.

Worst-case Estimates of 1756-BA1 Battery Life

Controller	Temperature	Time Before BAT LED Turns On			Time after BAT LED turns on and Power Is Cut Off
		Power off 100%	Power off 50%	Yearly decrease	
1756-L55M12 1756-L55M13	60 °C (140 °F)	57 days	110 days	23%	69 hours
	25 °C (77 °F)	63 days	123 days	17%	76 hours
	0 °C (32 °F)	60 days	118 days	17%	73 hours
1756-L55M14	60 °C (140 °F)	29 days	57 days	23%	35 hours
	25 °C (77 °F)	30 days	61 days	17%	37 hours
	0 °C (32 °F)	24 days	48 days	17%	30 hours
1756-L55M16	60 °C (140 °F)	15 days	30 days	23%	18 hours
	25 °C (77 °F)	13 days	27 days	17%	16 hours
	0 °C (32 °F)	6 days	12 days	36%	7 hours
1756-L55M22 1756-L55M23	Use the values for the 1756-L55M13 controller.				
1756-L55M24	Use the values for the 1756-L55M14 controller.				
1756-L63	60 °C (140 °F)	22 days	43 days	23%	6 hours
	25 °C (77 °F)	21 days	42 days	17%	28 hours
	0 °C (32 °F)	14 days	28 days	17%	2.5 days

Worst-case Estimates of 1756-BATM Battery Life

Controller	Temperature	Time Before BAT LED Turns On			Time after BAT LED turns on and Power Is Cut Off
		Power off 100%	Power off 50%	Yearly decrease	
1756-L55M12	60 °C (140 °F)	190 days	396 days	11%	190 days
1756-L55M13	25 °C (77 °F)	299 days	562 days	5%	299 days
	0 °C (32 °F)	268 days	562 days	6%	268 days
1756-L55M14	60 °C (140 °F)	130 days	270 days	11%	139 days
	25 °C (77 °F)	213 days	391 days	5%	228 days
	0 °C (32 °F)	180 days	381 days	6%	193 days
1756-L55M16	60 °C (140 °F)	71 days	160 days	13%	76 days
	25 °C (77 °F)	133 days	253 days	5%	142 days
	0 °C (32 °F)	105 days	220 days	6%	112 days
1756-L55M22	Use the values for the 1756-L55M13 controller.				
1756-L55M23					
1756-L55M24	Use the values for the 1756-L55M14 controller.				
1756-L63	60 °C (140 °F)	98 days	204 days	11%	104 days
	25 °C (77 °F)	146 days	268 days	5%	157 days
	0 °C (32 °F)	105 days	222 days	6%	113 days

Estimate 1756-BA2 Battery Life

(1756-L6x series B controllers only)

Use this table to estimate how much time will elapse before the battery becomes low (BAT LED = solid red) on 1756-L6x, series B controllers.

Worst-case Estimates of 1756-BA2 Battery Life

Temperature 2.54 cm. (1 in.) Below the Chassis, Max	Power Cycles	Battery Life Before the BAT LED Turns Red				
		Project Size				
		1 MB	2 MB	4 MB	8 MB	16 MB
0...40 °C (32...104 °F)	3 per day	3 years	3 years	26 months	20 months	10 months
	2 per day or less	3 years	3 years	3 years	31 months	16 months
41...45 °C (105.8...113 °F)	3 per day	2 years	2 years	2 years	20 months	10 months
	2 per day or less	2 years	2 years	2 years	2 years	16 months
46...50 °C (114.8...122 °F)	3 per day or less	16 months	16 months	16 months	16 months	10 months
51...55 °C (123.8...131 °F)	3 per day or less	11 months	11 months	11 months	11 months	10 months
56...60 °C (132.8...140 °F)	3 per day or less	8 months	8 months	8 months	8 months	8 months

Estimate Warning Time

Use this table to estimate the battery life after the low-battery warning (BAT LED = solid red). Use these times whether or not the controller has power. There is always a small drain on the battery.

IMPORTANT

When you power up the controller, see if there is a low-battery warning. If you get a low-battery warning for the first time, you have less battery life than this table shows. While powered down, the controller still drains the battery but it cannot give the low-battery warning.

Temperature 2.54 cm. (1 in.) Below the Chassis, Max	Power Cycles	Battery Life After the BAT LED Turns Red (Worst Case)				
		Project Size				
		1 MB	2 MB	4 MB	8 MB	16 MB
0...20 °C (32...68 °F)	3 per day	26 weeks	18 weeks	12 weeks	9 weeks	5 weeks
	1 per Day	26 weeks	26 weeks	26 weeks	22 weeks	13 weeks
	1 per Month	26 weeks	26 weeks	26 weeks	26 weeks	26 weeks
21...40 °C (69.8...104 °F)	3 per day	18 weeks	14 weeks	10 weeks	8 weeks	5 weeks
	1 per Day	24 weeks	21 weeks	18 weeks	16 weeks	11 weeks
	1 per Month	26 weeks	26 weeks	26 weeks	26 weeks	26 weeks
41...45 °C (105.8...113 °F)	3 per day	12 weeks	10 weeks	7 weeks	6 weeks	4 weeks
	1 per Day	15 weeks	14 weeks	12 weeks	11 weeks	8 weeks
	1 per Month	17 weeks	17 weeks	17 weeks	17 weeks	16 weeks
46...50 °C (114.8...122 °F)	3 per day	10 weeks	8 weeks	6 weeks	6 weeks	3 weeks
	1 per Day	12 weeks	11 weeks	10 weeks	9 weeks	7 weeks
	1 per Month	12 weeks	12 weeks	12 weeks	12 weeks	12 weeks
51...55 °C (123.8...131 °F)	3 per day	7 weeks	6 weeks	5 weeks	4 weeks	3 weeks
	1 per Day	8 weeks	8 weeks	7 weeks	7 weeks	5 weeks
	1 per Month	8 weeks	8 weeks	8 weeks	8 weeks	8 weeks
56...60 °C (132.8...140 °F)	3 per day	5 weeks	5 weeks	4 weeks	4 weeks	2 weeks
	1 per Day	6 weeks	6 weeks	5 weeks	5 weeks	4 weeks
	1 per Month	6 weeks	6 weeks	6 weeks	6 weeks	6 weeks

EXAMPLE

Under these conditions the battery will last at least 20 months before the BAT light turns red.

- The maximum temperature 2.54 cm. (1 in.) below the chassis = 45 °C (113 °F)
- You cycle power to the controller 3 times per day.
- The controller contains an 8 MB project.

Maintain a 1756-BATM Battery Module

Use the 1756-BATM battery module with any 1756-L55Mx or 1756-L6x, series A controller. The battery module is highly recommended for the higher-memory controllers.

Controller	Project	1756-BATM Battery Module
1756-L55M12	—————▶	Permitted
1756-L55M13	—————▶	Permitted
1756-L55M14	—————▶	Highly recommended
1756-L55M16	—————▶	Highly recommended
1756-L55M22	Stored in nonvolatile memory	Not required but permitted
	Not stored in nonvolatile memory	Permitted
1756-L55M23	Stored in nonvolatile memory	Not required but permitted
	Not stored in nonvolatile memory	Permitted
1756-L55M24	Stored in nonvolatile memory	Not required but permitted
	Not stored in nonvolatile memory	Highly recommended
1756-L63	Stored in nonvolatile memory—requires a 1784-CF64 Industrial CompactFlash card	Not required but permitted
	Not stored in nonvolatile memory	Highly recommended

When the 1756-BATA battery is about 50% discharged, the controller provides these warnings:

- Solid red BAT LED
- Minor fault (type 10, code 10).

Check the BAT LED Indicator

To check the BAT LED indicator, perform this procedure.

1. Turn on the chassis power.

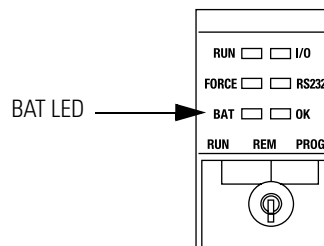

2. Is the BAT LED off?

If	Then
Yes	The battery module is correctly installed.
No	Go to step 3.

3. Check that the battery module is correctly connected to the controller.
4. Check that the battery assembly is correctly connected to the battery module.
5. If the BAT LED remains on, install another battery assembly (catalog number 1756-BATA).
6. If the BAT LED remains on after you complete step 5, contact your Rockwell Automation representative or local distributor.

Store Batteries

ATTENTION



Follow these general rules to store your batteries:

- Store batteries in a cool, dry environment. We recommend 25 °C (77 °F) with 40...60% relative humidity.
- You may store batteries for up to 30 days in temperatures from -45...85 °C (-49...185 °F), such as during transportation.
- To avoid leakage or other hazards, do not store batteries above 60 °C (140 °F) for more than 30 days.

Additional Resources

For detailed guidelines on how to store batteries, see Guidelines for Handling Lithium Batteries, publication AG 5-4, which comes with the battery.

Notes:

LED Indicators

Introduction

This appendix explains the LED indicators for ControlLogix controllers.

Topic	Page
RUN LED Indicator	131
I/O LED Indicator	131
FORCE LED Indicator	132
RS232 LED Indicator	132
BAT LED Indicator	132
OK LED Indicator	133

RUN LED Indicator

Condition	Indicates	Recommended Action
Off	The controller is in Program or Test mode.	Change the controller mode.
Solid green	The controller is in Run mode.	

I/O LED Indicator

Condition	Indicates	Recommended Action
Off	<ul style="list-style-type: none"> Either there are no devices in the I/O configuration of the controller. The controller does not contain a project (controller memory is empty). 	<ul style="list-style-type: none"> Add the required devices to the I/O configuration of the controller. Download the project to the controller.
Solid green	The controller is communicating with all the devices in its I/O configuration.	None
Flashing green	One or more devices in the I/O configuration of the controller are not responding.	Go online with RSLogix 5000 programming software and check the I/O configuration of the controller.
Flashing red	The chassis is bad.	Replace the chassis.

FORCE LED Indicator

Color	Description	Recommended Action
Off	<ul style="list-style-type: none"> No tags contain I/O force values. I/O forces are inactive (disabled). 	None
Solid amber	<ul style="list-style-type: none"> I/O forces are active (enabled). I/O force values may or may not exist. 	Use caution if you install (add) a force. If you install (add) a force, it immediately takes effect.
Flashing amber	One or more input or output addresses have been forced to an On or Off state, but the forces have not been enabled.	Use caution if you enable I/O forces. If you enable I/O forces, ALL existing I/O forces also take effect.

RS232 LED Indicator

Color	Description	Recommended Action
Off	There is no activity.	No action is required.
Solid green	Data is being received or transmitted	No action is required.

BAT LED Indicator

Color	Description		Recommended Action
Off	The battery supports memory.		None
Solid green	If the controller is	Then	
	Series A	The controller does not show this indication.	None
	Series B	During power-down, the controller is saving the project to its internal nonvolatile memory. If the BAT LED is solid red before you turn off the power, the BAT LED remains solid red even during the save.	None
Solid red	Either the battery is:		
	<ul style="list-style-type: none"> not installed. 		Install a battery.
	<ul style="list-style-type: none"> 95% or more discharged. 		Replace the battery.

OK LED Indicator

Color	Description		Recommended Action
Off	No power is applied.		When ready, turn on power to the controller.
Flashing red	If the controller is	Then	
	a new controller (just out of the box)	The controller requires a firmware update.	Update the controller with the correct firmware.
	NOT a new controller (previously in operation)	Major fault occurred.	Clear the fault.
Solid red	The controller detected a non-recoverable fault, so it cleared the project from memory.		Clear the fault.
Solid green	The controller is OK		None
Flashing green	The controller is storing or loading a project to or from nonvolatile memory.		If the controller has a CompactFlash card, leave the card in the controller until the OK LED turns solid green.

Notes:

Numerics

- 1756-HYD02**
 - add to controller 91
- 1756-M02AE**
 - add to controller 91
- 1756-M02AS**
 - add to controller 91
- 1756-M03SE**
 - add to controller 91
 - set up 95
- 1756-M08SE**
 - add to controller 91
 - set up 95
- 1756-M16SE**
 - add to controller 91
 - set up 95

A

- add**
 - axes 100
- add motion group** 97
- add motion modules** 91
- add SERCOS drives** 93
- Add-On Instructions** 73
- add-on instructions** 73
- address data** 60
- AOI** 73
- ASCII characters** 36
- axis**
 - check wiring 104
 - set up 101
- axis information**
 - obtain 108

B

- battery**
 - catalog number 123
 - check if low 124
 - estimate 1756-BA1 124
 - estimate 1756-BA2 126
 - maintain 1756-BATM 128
 - storage 129
- build redundant system** 113

C

- cable, serial** 15
- cache message** 49
- calculate connection use** 50
- catalog number** 12

change

equipment phase 87

change of state 55

chassis 54

coarse update period

set 97

communication

ControlNet network 25
 determine timeout with any device 76
 determine timeout with I/O module 77
 DeviceNet network 28
 DH+ network 41
 DH-485 network 37
 EtherNet/IP network 22
 format 55
 Foundation Fieldbus 45
 HART 46
 serial 31
 universal remote I/O 43

CompactFlash

load considerations 120
 overview 119
 reader 121
 supported controller 120

configuration folder 55

configure

ControlNet I/O module 58
 DeviceNet I/O module 59
 I/O module 55
 SERCOS interface modules 95
 serial driver 17

configure PhaseManager 83

connect

DeviceNet network 28
 DH+ network 41
 DH-485 network 37
 EtherNet/IP network 22
 Foundation Fieldbus 45
 HART 46
 RIO 43
 serial 15, 31

connection

calculate use 50
 consume data 48
 ControlNet network 27
 determine timeout with any device 76
 determine timeout with I/O module 77
 DeviceNet network 30
 EtherNet/IP network 24
 I/O module 56
 monitor 76
 produce data 48

connections

example 52

consume data

connection use 48

overview 21

control distributed I/O

overview 21

controller

battery module 128

catalog number 12

check battery 124

communication 47

CompactFlash 120

consume data 21

control distributed I/O 21

design 13

estimate battery life 124, 126

fault handler 78

install 13

message 21

monitor status 75

nonvolatile memory 120

path 19

produce data 21

redundancy 111

serial connection 15

status 75

ControlLogix redundancy 111**ControlLogix system overview 11****ControlNet**

module capability 26

ControlNet network

connection use 27

distributed I/O 58

overview 25

redundancy considerations 114

required software for communication 26

scheduled 27

unscheduled 27

coordinated system time master

set 90

COS 55**CST master 90**

See coordinated system time master

D**define**

programs 70

routines 70

tasks 69

define programs 70**design 13****develop**

applications 67

motion applications 89

programs 68

develop application

fault handler 78

monitor connection 76

monitor status 75

overview 67

programming language 73

tag 72

task 67

DeviceNet

distributed I/O 59

DeviceNet network

connection use 30

overview 28

DF1 device 32**DH+**

module capability 42

network overview 41

DH+ network

example configuration 42

DH-485 network

example configuration 37

overview 37

direct connection 56**distributed I/O**

ControlNet network 58

DeviceNet 59

overview 21

drive

add SERCOS interface drive 93

check wiring 104

E**electronic keying 55****EtherNet/IP network**

connection use 24

overview 22

redundancy considerations 115

example configuration

DH-485 network 37

F**fault handler 78****FBD 73****Foundation Fieldbus 45****function block diagram 73**

G**GSV instruction** 75**H****HART** 46**Highway Addressable Remote Transducer, see HART** 46**I****I/O**

address data 60
 chassis 54
 communication format 55
 configuration folder 55
 configure 53
 connection use 56
 COS 55
 determine update 63
 direct connection 56
 distributed via ControlNet 58
 distributed via DeviceNet 59
 electronic keying 55
 module capability 53
 monitor 53
 monitor connection 77
 place 53
 rack-optimized 56
 reconfigure module 64
 RPI 55

install 13**L****ladder diagram** 73**language** 73**LED Indicators** 131

BAT 132
 FORCE 132
 I/O 131
 OK 133
 RS232 132
 RUN 131

M**maintain**

battery 123

make controller CST master 90**manage**

controller communication 47
 tasks 67

message

cache 49
 overview 21
 reconfigure I/O module 65

Modbus support 37**monitor**

connections 76
 controller status 75

motion applications 89**motion control**

choose a motion module 91
 coarse update period 97
 execution 97
 overview 89
 program 109
 set the coordinated system time master 90

motion group

set up 97

motion instructions

overview 109

motion planner

set period 97

N**network communication** 21**networks**

overview 21

nonvolatile memory

load considerations 120
 overview 119
 supported controller 120

O**obtain**

axis information 108

organize tags 72**P****PhaseManager** 83

change states 87
 compare to other state models 87
 equipment phase instructions 88
 minimum system requirements 88
 state models 85

produce data

connection use 48
 overview 21

program

motion control 109

programming language 73

R

rack-optimized connection 56

receive

messages 49

reconfigure I/O module 64

redundancy

considerations 114
ControlNet network 114
EtherNet/IP network 115
example system 112
overview 111
requirements 113
switchover 112

redundant media 111

relay ladder 73

requested packet interval 55

RIO, see universal remote I/O 43

RPI 55

RS-232 DF1 Device driver 17

S

safety integration level, see SIL 2 117

sample controller projects 71

scheduled connections 27

select

programming language 73
system overhead percentage 79

send

messages 49

sequential function chart 73

SERCOS interface drive

add to controller 93

SERCOS interface modules

choose 91
set up 95

serial

cable 15

communicate with ASCII device

ASCII device 34

communicate with DF1 device 32

controller communication 31

controller connection 15

DH-485 network configuration 37

driver 17

Modbus support 37

select controller path 19

set up

axis 101

SERCOS module 95

SFC 73

SIL 2 certification

example application 118

overview 117

SSV instruction 75

ST 73

state model 85

overview 85

status 75

structured text 73

system overhead percentage 79

system requirements

PhaseManager 88

T

tag

organize 72

task 67

tune axis 106

U

universal remote I/O

module capability 44

overview 43

unscheduled connections 27

update 63



How Are We Doing?

Your comments on our technical publications will help us serve you better in the future. Thank you for taking the time to provide us feedback.

You can complete this form and mail (or fax) it back to us or email us at RADocumentComments@ra.rockwell.com

Pub. Title/Type ControlLogix Controllers Firmware Revision 15 User Manual

Cat. No. 1756-L55Mx, 1756-L6x Pub. No. 1756-UM001G-EN-P Pub. Date January 2007 Part No. 953014-93

Please complete the sections below. Where applicable, rank the feature (1=needs improvement, 2=satisfactory, and 3=outstanding).

Overall Usefulness 1 2 3	How can we make this publication more useful for you?		
Completeness (all necessary information is provided) 1 2 3	Can we add more information to help you?		
	procedure/step	illustration	feature
	example	guideline	other
	explanation	definition	
Technical Accuracy (all provided information is correct) 1 2 3	Can we be more accurate?		
	text	illustration	
Clarity (all provided information is easy to understand) 1 2 3	How can we make things clearer?		
Other Comments	You can add additional comments on the back of this form.		

Your Name _____
 Your Title/Function _____
 Location/Phone _____

Would you like us to contact you regarding your comments?
 No, there is no need to contact me
 Yes, please call me
 Yes, please email me at _____
 Yes, please contact me via _____

Return this form to: Rockwell Automation Technical Communications, 1 Allen-Bradley Dr., Mayfield Hts., OH 44124-9705
 Fax: 440-646-3525 Email: RADocumentComments@ra.rockwell.com

PLEASE FASTEN HERE (DO NOT STAPLE)

Other Comments

PLEASE FOLD HERE

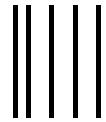

NO POSTAGE
NECESSARY
IF MAILED
IN THE
UNITED STATES

PLEASE REMOVE

BUSINESS REPLY MAIL

FIRST-CLASS MAIL PERMIT NO. 18235 CLEVELAND OH

POSTAGE WILL BE PAID BY THE ADDRESSEE



**Rockwell
Automation**

1 ALLEN-BRADLEY DR
MAYFIELD HEIGHTS OH 44124-9705

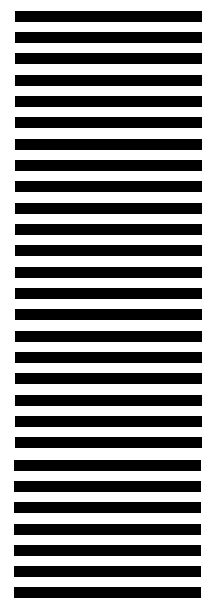

ASCII Character Codes

Character	Dec	Hex	Character	Dec	Hex	Character	Dec	Hex	Character	Dec	Hex
[ctrl-@] NUL	0	\$00	SPACE	32	\$20	@	64	\$40	'	96	\$60
[ctrl-A] SOH	1	\$01	!	33	\$21	A	65	\$41	a	97	\$61
[ctrl-B] STX	2	\$02	"	34	\$22	B	66	\$42	b	98	\$62
[ctrl-C] ETX	3	\$03	#	35	\$23	C	67	\$43	c	99	\$63
[ctrl-D] EOT	4	\$04	\$	36	\$24	D	68	\$44	d	100	\$64
[ctrl-E] ENQ	5	\$05	%	37	\$25	E	69	\$45	e	101	\$65
[ctrl-F] ACK	6	\$06	&	38	\$26	F	70	\$46	f	102	\$66
[ctrl-G] BEL	7	\$07	'	39	\$27	G	71	\$47	g	103	\$67
[ctrl-H] BS	8	\$08	(40	\$28	H	72	\$48	h	104	\$68
[ctrl-I] HT	9	\$09)	41	\$29	I	73	\$49	i	105	\$69
[ctrl-J] LF	10	\$1 (\$0A)	*	42	\$2A	J	74	\$4A	j	106	\$6A
[ctrl-K] VT	11	\$0B	+	43	\$2B	K	75	\$4B	k	107	\$6B
[ctrl-L] FF	12	\$0C	,	44	\$2C	L	76	\$4C	l	108	\$6C
[ctrl-M] CR	13	\$r (\$0D)	-	45	\$2D	M	77	\$4D	m	109	\$6D
[ctrl-N] SO	14	\$0E	.	46	\$2E	N	78	\$4E	n	110	\$6E
[ctrl-O] SI	15	\$0F	/	47	\$2F	O	79	\$4F	o	111	\$6F
[ctrl-P] DLE	16	\$10	0	48	\$30	P	80	\$50	p	112	\$70
[ctrl-Q] DC1	17	\$11	1	49	\$31	Q	81	\$51	q	113	\$71
[ctrl-R] DC2	18	\$12	2	50	\$32	R	82	\$52	r	114	\$72
[ctrl-S] DC3	19	\$13	3	51	\$33	S	83	\$53	s	115	\$73
[ctrl-T] DC4	20	\$14	4	52	\$34	T	84	\$54	t	116	\$74
[ctrl-U] NAK	21	\$15	5	53	\$35	U	85	\$55	u	117	\$75
[ctrl-V] SYN	22	\$16	6	54	\$36	V	86	\$56	v	118	\$76
[ctrl-W] ETB	23	\$17	7	55	\$37	W	87	\$57	w	119	\$77
[ctrl-X] CAN	24	\$18	8	56	\$38	X	88	\$58	x	120	\$78
[ctrl-Y] EM	25	\$19	9	57	\$39	Y	89	\$59	y	121	\$79
[ctrl-Z] SUB	26	\$1A	:	58	\$3A	Z	90	\$5A	z	122	\$7A
ctrl-[ESC	27	\$1B	;	59	\$3B	[91	\$5B	{	123	\$7B
[ctrl-\] FS	28	\$1C	<	60	\$3C	\	92	\$5C		124	\$7C
ctrl-] GS	29	\$1D	=	61	\$3D]	93	\$5D	}	125	\$7D
[ctrl-^] RS	30	\$1E	>	62	\$3E	^	94	\$5E	~	126	\$7E
[ctrl-_] US	31	\$1F	?	63	\$3F	_	95	\$5F	DEL	127	\$7F

Rockwell Automation Support

Rockwell Automation provides technical information on the web to assist you in using our products. At <http://support.rockwellautomation.com>, you can find technical manuals, a knowledge base of FAQs, technical and application notes, sample code and links to software service packs, and a MySupport feature that you can customize to make the best use of these tools.

For an additional level of technical phone support for installation, configuration and troubleshooting, we offer TechConnect Support programs. For more information, contact your local distributor or Rockwell Automation representative, or visit <http://support.rockwellautomation.com>.

Installation Assistance

If you experience a problem with a hardware module within the first 24 hours of installation, please review the information that's contained in this manual. You can also contact a special Customer Support number for initial help in getting your module up and running:

United States	1.440.646.3223 Monday – Friday, 8am – 5pm EST
Outside United States	Please contact your local Rockwell Automation representative for any technical support issues.

New Product Satisfaction Return

Rockwell tests all of our products to ensure that they are fully operational when shipped from the manufacturing facility. However, if your product is not functioning and needs to be returned:

United States	Contact your distributor. You must provide a Customer Support case number (see phone number above to obtain one) to your distributor in order to complete the return process.
Outside United States	Please contact your local Rockwell Automation representative for return procedure.

www.rockwellautomation.com

Power, Control and Information Solutions Headquarters

Americas: Rockwell Automation, 1201 South Second Street, Milwaukee, WI 53204-2496 USA, Tel: (1) 414.382.2000, Fax: (1) 414.382.4444

Europe/Middle East/Africa: Rockwell Automation, Vorstlaan/Boulevard du Souverain 36, 1170 Brussels, Belgium, Tel: (32) 2 663 0600, Fax: (32) 2 663 0640

Asia Pacific: Rockwell Automation, Level 14, Core F, Cyberport 3, 100 Cyberport Road, Hong Kong, Tel: (852) 2887 4788, Fax: (852) 2508 1846