

SIEMENS

SIMATIC

Application Module FM 458-1 DP

User Manual

Edition 04.2011
A5E01078222-03

Contents

Definitions and support **1**

Product description **2**

Mounting **3**

Configuring **4**

Assembly guidelines **5**

Index

Safety guidelines

This manual contains notices you have to observe in order to ensure your personal safety, as well as to prevent damage to property. The notices referring to your personal safety are highlighted in the manual by a safety alert symbol, notices referring to property damage only have no safety alert symbol. The notices shown below are graded according to the degree of danger.



Danger

indicates that death or severe personal injury **will** result if proper precautions are not taken.



Warning

indicates that death or severe personal injury **may** result if proper precautions are not taken.



Caution

with a safety alert symbol indicates that minor personal injury can result if proper precautions are not taken.

Caution

without a safety alert symbol indicates that property damage can result if proper precautions are not taken.

Attention

indicates that an unintended result or situation can occur if the corresponding notice is not taken into account.

If more than one degree of danger is present, the warning notice representing the highest degree of danger will be used. A notice warning of injury to persons with a safety alert symbol may also include a warning relating to property damage.

Qualified Personnel

The device/system may only be set up and used in conjunction with this documentation. Commissioning and operation of a device/system may only be performed by **qualified personnel**. Within the context of the safety notices in this documentation qualified persons are defined as persons who are authorized to commission, ground and label devices, systems and circuits in accordance with established safety practices and standards.

Prescribed Usage

Note the following:



Warning

This device and its components may only be used for the applications described in the catalog or the technical description, and only in connection with devices or components from other manufacturers which have been approved or recommended by Siemens. Correct, reliable operation of the product requires proper transport, storage, positioning and assembly as well as careful operation and maintenance.

Trademarks

All names identified by ® are registered trademarks of the Siemens AG. The remaining trademarks in this publication may be trademarks whose use by third parties for their own purposes could violate the rights of the owner.

(A)

가

Copyright Siemens AG 2011 All rights reserved

The distribution and duplication of this document or the utilization and transmission of its contents are not permitted without express written permission. Offenders will be liable for damages. All rights, including rights created by patent grant or registration of a utility model or design, are reserved

Disclaimer of Liability

We have reviewed the contents of this publication to ensure consistency with the hardware and software described. Since variance cannot be precluded entirely, we cannot guarantee full consistency. However, the information in this publication is reviewed regularly and any necessary corrections are included in subsequent editions.

Siemens AG
Automation and Drives
Geschäftsgebiet Industrial Automation Systems
Postfach 4848, D- 90327 Nürnberg

Siemens AG 2011
Technical data subject to change.

Contents

1	Definitions and Support.....	1-1
1.1	Definitions.....	1-1
1.2	Support.....	1-2
2	Product description	2-1
2.1	Application module FM 458-1 DP	2-1
2.1.1	Updating the Firmware of FM 458-1 DP	2-2
2.1.2	Application and design	2-3
2.1.3	Performance features.....	2-6
2.1.4	Supplementary components.....	2-8
2.1.5	Connections.....	2-9
2.1.6	Status displays	2-12
2.1.7	Behavior of the FM458-1 DP from the perspective of the S7-400 CPU when the operating state changes.....	2-13
2.1.8	Technical data	2-15
2.2	I/O expansion module EXM 438-1	2-16
2.2.1	Application and design	2-16
2.2.2	Performance features.....	2-17
2.2.3	Supplementary components.....	2-18
2.2.4	Connection possibilities.....	2-19
2.2.5	Incremental encoder settings	2-26
2.2.6	Cables for SSI and incremental encoders.....	2-27
2.2.7	Analog inputs.....	2-27
2.2.8	Technical data	2-28
2.3	Communications expansion module EXM 448	2-33
2.3.1	Application and design	2-33
2.3.2	Performance features.....	2-34
2.3.3	PROFIBUS	2-34
2.3.4	Connection possibilities.....	2-35
2.3.5	Status displays	2-37
2.3.6	Technical data	2-38
2.4	Communications expansion module EXM 448-2	2-39
2.4.1	Application and design	2-39
2.4.2	Performance features.....	2-40
2.4.3	Connection possibilities.....	2-41
2.4.4	Status displays	2-42
2.4.5	Technical data	2-42
3	Mounting	3-1
3.1	Mounting the expansion modules	3-1
3.2	Installing the assembly into the SIMATIC subrack.....	3-7
3.3	Application information and noise immunity.....	3-8

4	Configuring	4-1
4.1	Freely configuring the FM 458-1 DP application module	4-1
4.2	Configuring and parameterizing the components	4-3
4.3	Coupling to the SIMATIC S7-CPU	4-6
4.3.1	Overview of the 3 data transfer types, FM 458-1 DP ↔ SIMATIC-CPU	4-7
4.3.2	Initiating a process interrupt on SIMATIC-CPU	4-8
4.3.3	Data transfer via I/O accesses	4-9
4.3.4	Transferring data sets	4-12
4.4	PROFIBUS DP coupling	4-15
4.4.1	General basics	4-15
4.4.2	Configuring	4-15
4.4.2.1	Configuring the DP master system on FM 458-1 DP	4-15
4.4.2.2	Configuring the communications in CFC	4-16
4.4.3	Equidistance and clock synchronism	4-18
4.4.4	SYNC/FREEZE commands	4-19
4.4.4.1	Configuring versions of SYNC/FREEZE	4-19
4.4.5	Commissioning/diagnostics	4-24
4.4.5.1	Diagnostics function block	4-24
4.4.5.2	Error class (ECL) and error code (ECO)	4-27
4.4.6	Application example - PROFIBUS DP coupling	4-27
4.5	Introduction "Pointer-based communication blocks"	4-28
4.5.1	Principle mode of operation	4-28
4.5.2	Applications	4-28
4.5.3	Features of pointer-based communications	4-29
4.5.4	Associated function blocks	4-30
4.5.5	Pointer interface	4-31
4.5.6	Configuring information and instructions	4-31
4.5.7	Examples of CFC screenshots	4-32
4.6	SIMOLINK drive coupling	4-37
4.6.1	Basic information	4-37
4.6.2	Application with master-slave process data transfer	4-39
4.6.3	Applications and modes which should be set	4-40
4.6.4	Configuring - first steps	4-44
4.6.4.1	Configuring the SIMOLINK coupling under STEP 7	4-44
4.6.4.2	SIMOLINK function blocks	4-49
4.6.4.3	Parameterizing the MASTERDRIVES MC	4-50
4.6.5	Coupling diagnostics	4-52
4.6.6	Synchronizing individual SIMOLINK rings	4-54
4.6.7	Options and accessories	4-55
4.7	Table function	4-56
4.7.1	Introduction	4-56
4.7.1.1	Overview, "Manual mode"	4-57
4.7.1.2	Overview, "Automatic mode: Communications"	4-57
4.7.1.3	Function block WR_TAB	4-59
4.7.2	Manual mode	4-62
4.7.2.1	Application	4-62
4.7.2.2	Configuring	4-63
4.7.3	Automatic mode: Communications	4-64
4.7.3.1	Application with an S7 control and SIMATIC FM 458-1 DP application module	4-64
4.7.3.2	Configuring for S7 control and SIMATIC FM 458-1 DP application module	4-66

4.7.3.3	Inserting tabular values in the data block.....	4-67
4.7.3.3.1	Manually entering tabular values	4-67
4.7.3.3.2	Importing tabular values	4-71
4.7.3.3.3	Subsequently downloading tabular values into a DB.....	4-81
4.7.3.4	Structure of the data telegram for TCP/IP or DUST1 connection	4-83
4.7.4	Automatic mode: Memory card	4-84
4.7.4.1	Generating a table file in the csv format.....	4-84
4.7.4.2	Working with the D7-SYS additionalComponentBuilder	4-86
4.7.4.3	Downloading.....	4-89
4.7.4.4	Configuring the function blocks	4-91
4.8	Parameter access technique for D7-SYS	4-93
4.8.1	General description of the parameter functionalityinformation	4-93
4.8.1.1	Parameters	4-93
4.8.1.2	BICO technology for SIMADYN D.....	4-96
4.8.1.3	Status-dependent parameter changes.....	4-100
4.8.1.4	Identifying SIMADYN D components	4-100
4.8.1.5	Units and unit texts.....	4-102
4.8.2	Parameterizing on the Application module FM 458-1 DP	4-105
4.8.2.1	Terminology.....	4-105
4.8.2.2	Communications behavior.....	4-105
4.8.2.3	Generating the hardware configuration.....	4-106
4.8.2.4	Functional scope	4-106
4.8.2.5	Operator devices which can be connected	4-107
4.9	WinCC connection to FM458-1 DP channel (SIMATIC S7 Protocol Suite.CHN).....	4-108
4.9.1	Coupling via TCP/IP with "OCM" functions.....	4-109
4.9.1.1	Configuring the coupling-relevant S7 hardware.....	4-109
4.9.1.2	Configuring the CFC, marking the function block connections and creating the address book.....	4-110
4.9.1.3	Configuring WinCC.....	4-115
4.9.2	"S7DB" configuration version	4-122
4.9.3	MPI and PROFIBUS DP coupling versions.....	4-124
4.9.3.1	Hardware configuration	4-124
4.9.3.2	Configuring the CFC.....	4-128
4.9.3.3	Configuring WinCC.....	4-128
4.9.4	Configuring using the D7-SYS-OS engineering tool "Mapper"	4-131
5	Assembly guidelines.....	5-1
5.1	Installation and EMC guidelines.....	5-1
5.1.1	Definitions.....	5-1
5.1.1.1	Qualified personnel	5-1
5.1.1.2	Danger and warning information	5-2
5.1.2	Introduction.....	5-3
5.1.3	Standards and certifications	5-4
5.1.3.1	FM 458-1 DP outputs	5-4
5.1.3.2	Professionally-trained and knowledgeable personnel	5-4
5.1.3.3	Connecting external voltages	5-4
5.1.4	Mounting and operation.....	5-4
5.1.5	Subrack	5-5
5.1.6	Cables	5-5
5.1.7	Potential bonding.....	5-6
5.1.8	Principle when connecting components.....	5-6
5.1.9	Potential bonding rail.....	5-6
5.1.10	Protective grounding	5-7
5.1.11	Cabinet	5-7

5.1.12	Mounting clearances	5-8
5.1.13	Ground connection for configurations which are not isolated	5-8
5.1.14	Air guidance.....	5-8
5.1.15	Power loss in the cabinet.....	5-8
5.1.16	Power supply	5-8
5.2	ESD guidelines	5-10
5.3	Ambient conditions	5-10
Index		I-1

1 Definitions and Support

1.1 Definitions

General information

These Operating Instructions do not contain all of the detailed information for all product types for reasons of transparency. This means that they cannot take into account all conceivable situations regarding the configuration, operation or service. If you require additional information, or if specific problems occur, which are not handled in sufficient detail in the Operating Instructions, then you can request the necessary information from your local Siemens Office.

We would also like to point-out, that the contents of the operating instructions are neither part of an earlier or existing agreement, statement or legal relationship, nor do they change this. All of the contractual responsibilities of Siemens AG are specified in the purchase contract which includes the complete and exclusively valid warranty. The contractual warranty is neither expanded nor restricted by the information provided in these Operating Instructions.

Qualified personnel

For the purpose of these Operating Instructions and product labels, a „Qualified person“ is someone who is familiar with the installation, mounting, start-up and operation of the equipment and the hazards involved. He or she must have the following qualifications:

1. Trained and authorized to energize, de-energize, clear, ground and tag circuits and equipment in accordance with established safety procedures.
2. Trained in the proper care and use of protective equipment in accordance with established safety procedures.
3. Trained in rendering first aid



CAUTION

The boards contain components which can be destroyed by electrostatic discharge. Prior to touching any electronics board, your body must be electrically discharged. This can be simply done by touching a conductive, grounded object immediately beforehand (e.g. bare metal cabinet components, socket protective conductor contact).

1.2 Support

Service & Support im Internet

In addition to our paper documentation, our complete knowledge base is available to you on the Internet at:

<http://www.siemens.com/automation/service&support>

There, you will find the following information:

- Newsletters providing the latest information on your products
- A search engine in Service & Support for locating the documents you need
- A forum where users and experts from all over the world exchange ideas
- Your local contact partner for Automation & Drives in our Contact Partners database
- Information about on-site service, repairs, spare parts, and much more under "Services"

2 Product description

2.1 Application module FM 458-1 DP

Designation	Order No.
Application module FM 458-1 DP	6DD1607-0AA1 or 6DD1607-0AA2

The application module FM458-1 DP with the order number 6DD1607-0AA1 is replaced through the module with the order number 6DD1607-0AA2 (100 % compatible).

NOTE

Where two different values are specified for a feature (separated by „ / ”) in the manual, the first is valid for the module with the order number 6DD1607-0AA1 and the second for the module with the order number 6DD1607-0AA2.

The following CPUs (from V3.1.0) have been released for operation with the FM 458-1 DP application module.

Designation	Order No.
CPU412-1	6ES7 412-1XF03-0AB0
CPU412-2	6ES7 412-2XG00-0AB0
CPU414-2	6ES7 414-2XG03-0AB0
CPU414-3	6ES7 414-3XJ00-0AB0
CPU416-2	6ES7 416-2XK02-0AB0
CPU416F-2	6ES7 416-2FK02-0AB0
CPU416-3	6ES7 416-3XL00-0AB0
CPU417-4	6ES7 417-4XL00-0AB0
CPU414-4H	6ES7 414-4HJ00-0AB0
CPU417-4H	6ES7 417-4HL01-0AB0

2.1.1 Updating the Firmware of FM 458-1 DP

In which situations should I update the firmware?

After (compatible) function expansions the firmware should be upgraded to the latest version (update).

Where do I get the latest version of the firmware?

You can obtain the latest firmware versions from your Siemens partner or from the Internet (Siemens home page; Automation and Drives, Customer Support).

Updating the firmware

How to update the firmware (FW):

Step	Action required	CPU Response
1.	Transfer update files to a blank MMC using STEP 7 and your programming device.	-
2.	De-energize the FM458-1 DP and insert an MMC containing the FW update.	-
3.	POWER ON.	<ul style="list-style-type: none"> • The FM458-1 DP detects the MMC with the FW update automatically and starts the FW update. • All LEDs are lit during FW update. • After completion of the FW update, the STOP LED flashes.
4.	De-energize the FM458-1 DP and remove the MMC containing the FW update.	-

Table 2-1 Updating the firmware with MMC

2.1.2 Application and design

Application

The FM 458-1 DP application module has been designed for high-performance closed-loop control and technological applications (e.g. Motion Control) which can be freely configured using CFC and optionally SFC. It is designed for use in a SIMATIC S7-400 station.

Together with two additional plug-in expansion modules, the FM 458-1 DP allows a large number of high-dynamic applications, especially drive-related applications to be implemented.

These include, for example, closed-loop torque, speed and position controls for:

- Converter-fed DC and three-phase drives,
- Winder with closed-loop tension/dancer roll controls, coilers
- Multi-motor drives, "breakproof" electronic shaft
- Complex setpoint inputs for e.g. crosscutters/flying saws, gearbox/motor test stands
- High dynamic performance hydraulic drives in presses.

Expansion modules

Designation	Order No.
Input/output expansion module EXM 438-1	6DD1607-0CA1
Communications expansion module EXM 448	6DD1607-0EA0
Communications expansion module EXM 448-2	6DD1607-0EA2

The FM can be supplemented by the following expansion modules for fast process coupling:

- The I/O expansion module EXM 438-1 provides binary and analog I/O as well as incremental and absolute value encoders.
- The EXM 448 communications expansion module offers an additional PROFIBUS-DP interface (master or slave). Optionally, MASTERDRIVES plug-in modules, e.g. SLB for SIMOLINK and SBM2 for higher-resolution multi-turn encoders can be used to increase their functionality.

A maximum of two expansion modules can be used together with the FM 458-1 DP application. The following combinations are possible:

All of the possible combinations are permitted.

NOTES

The following restrictions exist when using the FM 458-1 DP application module in an S7-400 expansion controller (EC):

- Rack number of the EC 1..6
- EC is a UR1/UR2
- The coupling is realized through a K-bus capable IM pair: IM460-/461-0, or IM460-/461-3

The S7-CPU module must read-in signals from the SIMATIC I/O and send these to the FM 458-1 DP.

When configuring/engineering the system, please ensure that the maximum load capability of the S7 power supply module is not exceeded as a result of the current drawn by the FM 458-1 DP module. When using an IM module, which is used to transfer power to other modules, its maximum load capability must also be observed.

Ground-free operation is not possible when using the EXM 438-1.

FM 458-1 DP is an “open type” and therefore only can be installed in closed switch cabinets or switch rooms.

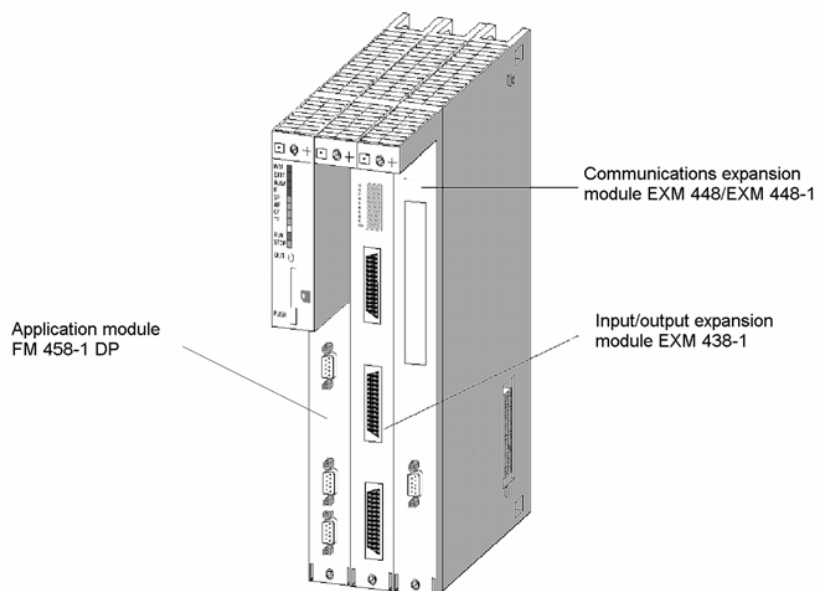

Fig. 2-1 FM 458-1 DP application module with two expansion modules

Design

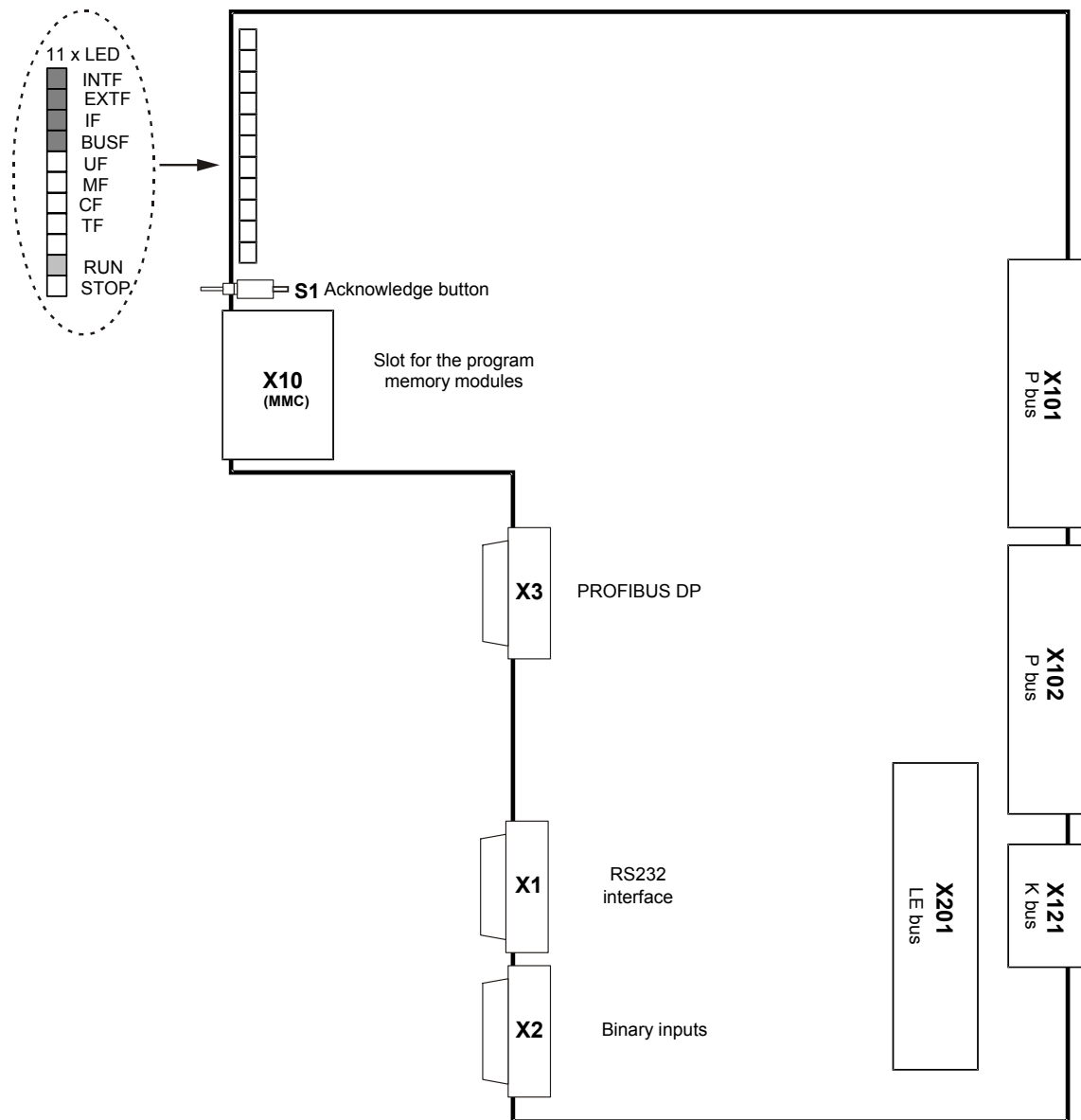

Fig. 2-2 Mechanical design of the FM 458-1 DP application module

2.1.3 Performance features

The FM 458-1 DP application module has been designed for high dynamic performance closed-loop control and technological applications in a SIMATIC S7-400 station. These control tasks can be freely configured using CFC or optionally SFC. Furthermore, it offers a PROFIBUS-DP connection.

- Computational performance
 - 64 bit RISC floating-point processor for arithmetic calculations
 - fastest cycle times of 0.1 ms – typical, 0.5 ms
 - 32-bit controller for communication tasks
- DRAM / SDRAM working memory
 - 16 / 64 MB
 - 12 MB / 60 MB useable for user program
 - the program code is loaded and expanded when initializing from the memory module
 - data memory for this operating system, user program, communications, message buffer, trace
- SRAM (256 kB / 512 kB)

The externally buffered SRAM contains the following data, which should be saved (non-volatile) even when the power fails:

 - fault diagnostics of the operating system ("exception buffer")
 - max. approx. 1000 / 2000 process quantities, configured using the SAV function block
 - data, traced using the message system or trace function (optional SRAM configuring)
- Replaceable program memories (2, 4, or 8 MB)
 - MMC (**M**icro **M**emory **C**ard), typical size: 2 MB
- Two interfaces are available to load the user program into the program memory:
 - via an MMC card slot (loading offline), e.g. field PG, USB prommer
 - directly from the PC via the MPI interface of a SIMATIC CPU (loading online)

- PROFIBUS DP interface with SIMATIC compatibility
 - equidistant (isochron)
 - lock-cycle synchronous
 - slave-to-slave communications capability
 - routing, e.g. teleservice
- 8 alarm tasks can be called via 8 binary inputs.
- RS 232 interface (V.24) with service protocol DUST1 (19.2 kBd) for:
 - Spline edit
 - Symtrace
- 11 LEDs to display the operating status
- Acknowledge button
Sporadically occurring faults (TF) or non-critical faults (FM) can be cancelled in the LED display using the acknowledge button. If another fault/error exists, then it is displayed after the first has been acknowledged.
- LE bus
The local expansion bus guarantees fast data transfer between the FM 458-1 DP application module and its expansion modules EXM 438-1 and EXM 448/EXM 448-2.

2.1.4 Supplementary components

Component	Designation	Order No.
Program memory <ul style="list-style-type: none"> • MMC Program memory module, 2 Mbyte • MMC Program memory module, 4 Mbyte • MMC Program memory module, 8 Mbyte 	MMC	<ul style="list-style-type: none"> • 6ES7953-8LL00-0AA0 • 6ES7953-8LM00-0AA0 • 6ES7953-8LP10-0AA0
PROFIBUS bus cable with PROFIBUS bus terminal with integrated terminating resistors and plug-in cable		Refer to Siemens, Industrial Communications and Field Devices, Catalog IK PI 2000 e.g. 6GK1500-0AA00
PROFIBUS bus cable with PROFIBUS bus coupler with integrated terminating resistors (up to 12 Mbit/s)		Refer to Siemens, Industrial Communications and Field Devices, Catalog IK PI 2000 e.g. 6ES7972-0BB10-0XA0 6ES7972-0BB40-0XA0
Cable for PC (9-pin/9-pin) to connect to an FM 458-1 DP	SC57	6DD1684-0FH0
Cable for FM 458-1 DP (9-pin/10-pin) to connect an SBxx or SU12 to the binary inputs of the FM 458-1 DP, length: 2m	SC64	6DD1684-0GE0
Interface module 10 pin direct connection (1:1 converter)	SU12	6DD1681-0AJ1
Interface module Binary inputs and outputs	SB10	6DD1681-0AE2
Interface module Binary inputs 24/48 V	SB61	6DD1681-0EB3
power supply connector for Interface module SB10, SB61	SM11	6DD1680-0BB0

Table 2-2 Supplementary components for the FM 458-1 DP application module

For further informations about the interface modules see documentation "SIMADYN D Hardware"

2.1.5 Connections

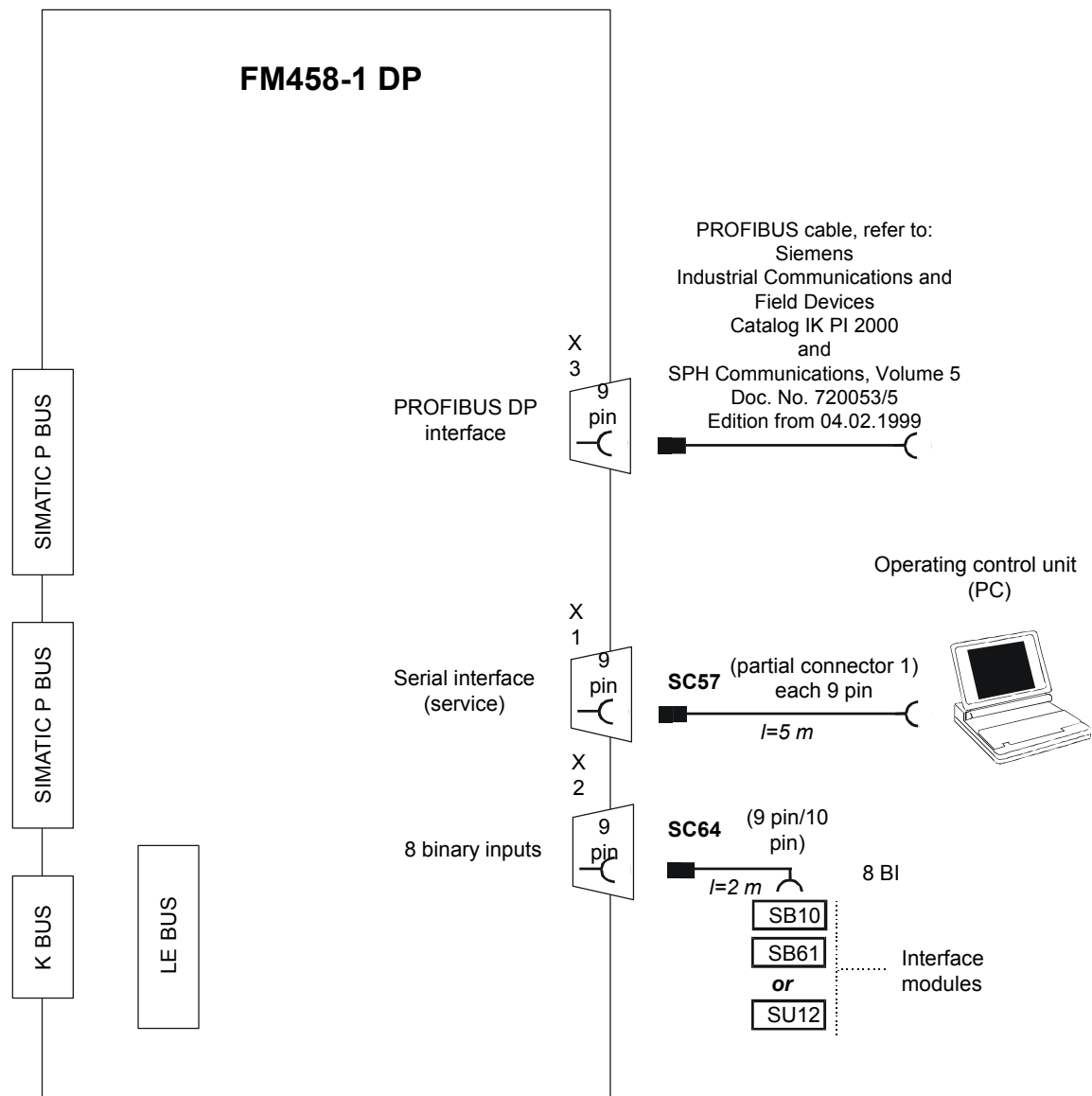
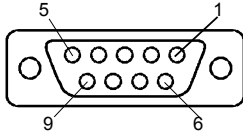

Fig. 2-3 Possibilities of connecting the FM 458-1 DP application module

Serial service interface (X1)



An operator control or configuring-PC is connected to the 9-pin sub-D socket via the SC57 PC cable.

X1	
PIN	Designation
1	-
2	Receive -Data In
3	Transmit Data Out
4	-
5	Ground 0V
6	-
7	-
8	-
9	-
Enclosure	Shield

SC57	
PIN FM-side	PIN PC-side
-	-
2	3
3	2
-	-
5	5

Table 2-3 Connector assignment of X1 and SC57 cable

Binary inputs (X2)

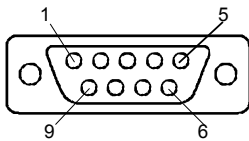

The binary inputs are connected at the 9-pin sub-D socket via cable SC64.

PIN	Designation
1	Interrupt input 1
2	Interrupt input 3
3	Interrupt input 5
4	Interrupt input 7
5	Ground 0V
6	Interrupt input 2
7	Interrupt input 4
8	Interrupt input 6
9	Interrupt input 8
Enclosure	Shield

Table 2-4 Connector assignment of X2

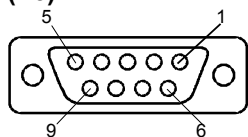
PROFIBUS interface (X3)

The PROFIBUS DP interface is connected to the 9-pin sub-D socket.

PIN	Designation
1	Not assigned / Ground M24V (non-isolated)
2	Not assigned
3	Line B (input/output)
4	RTS from AS (input)
5	Ground 5Vexternal, floating
6	5Vexternal power supply voltage, floating
7	Not assigned / supply voltage P24V (non-isolated)
8	Line A (input/output)
9	RTS from PG (output)
Enclosure	Shield

Table 2-5 Connector assignment of X3

NOTE

Maximal permissible load for 5Vexternal: 90 mA

**WARNING**

There is a potential danger that connectors X1 and X3 are interchanged (both connectors are sub-D 9 socket connectors).

LE-bus connection

An expansion module (EXM438-1 or EXM 448/EXM 448-2) can be inserted at this 5 x 24-pin socket connector.

P-bus connection

Two 5 x 17-pin socket connectors are the connectors on SIMATIC S7 backplane bus. K-bus connection

A 5 x 7-pin socket connector is provided to connect to the SIMATIC K bus.

Interface modules

The terminals for the binary inputs are available via the interface modules.

Interface modules	Function
SB10, SU12	Electrical 1:1 connection, no signal conversion
SB61	With electrical isolation and signal conversion

Refer to Catalog ST DA for information on the interface modules.

NOTE

The operation of the FM 458-1 DP is only allowed with these interface modules.

The interface modules are “open type” and therefore only can be installed in closed switch cabinets or switch rooms.

2.1.6 Status displays

There are eleven LED displays on the front panel of the FM 458-1 DP. They provide information about its actual operating status and data for diagnostics. After the voltage runs-up, all LEDs are "DARK".

LED	Color	Status	Significance
INTF	Red	Bright	Internal fault , user program is not running
EXTF	Red	Bright	External fault (External Failure) e.g. bus fault, connection failed The fault is resolved after troubleshooting outside the module.
IF	Red	Bright	Initialization error For errors which occur when initializing the system, the user program does not start. Initialization errors due to incorrect modules or modules which are incorrectly inserted with respect to how they were originally configured
BUSF	Red	Bright	PROFIBUS DP- bus fault Bus fault for CPUs with integrated DP interface
		Flashing	One or several slaves at the PROFIBUS DP interface do not respond.
UF	Yellow	Flashing	User error User program runs, can be controlled by the user with the USF function block
MF	Yellow	Bright	Monitoring error The user program runs, error during initialization which permits standard operation to start, e.g. missing or discharged buffer battery.
CF	Yellow	Bright	Communications error The user program runs, incorrectly configured communications or erroneous connection to SIMATIC S7-CPU or EXM 448
TF	Yellow	Bright	Task administration error The user program runs, the following error cases are possible: <i>Cycle error</i> a task was not able to be completed within the task sampling time. <i>Task back-up</i> if the task is not tagged as a task to run with the highest priority - but it must be restarted. <i>No free local buffer</i> the data buffer is no longer enabled. Task start is bypassed. <i>Software Watchdog</i> if the basic sampling time is not processed four times one after the other. The basic clock cycle timer is re-initialized with the configured basic sampling time and processing is continued.
RESERVED	Yellow	Dark	Don't care
RUN	Green	Bright	RUN condition The user program runs, the module operates normally also if UF, MF, CF or TF = "bright"
		Flashing	Initialization running

STOP	Yellow	Bright	STOP status The user program is not running, the module is at stop, e.g. or fatal system, initialization errors or the S7-CPU is at stop
		Flashing	Download running in the STOP condition.

Table 2-6 Significance of the LED status displays

Errors can be acknowledged by pressing the acknowledge button. If an additional error exists, it is displayed after the first error has been acknowledged.

NOTE

More information on the diagnostic possibilities, refer to the User Documentation Manual "STEP 7 option packages for D7-SYS", Chapter "Basis software", Section "Diagnostics".

2.1.7 Behavior of the FM458-1 DP from the perspective of the S7-400 CPU when the operating state changes

Behavior when transferring data sets at operating state transitions

- Transition of the FM458-1 DP from STOP->RUN:
The data sets, configured in the CFC (using @CPB, CRV, CTV) are, before the transition to RUN, set-up on the FM side. The configured data sets are only enabled for the S7-CPU after the communications processing on the FM side has completely established its administration. In RUN, this takes several task cycles on the FM side. On the S7-CPU, this is detected in the user program in so much that the SFC58 (WR_REC) still supply value 0x80B0 and the SFC59 (RD_REC) still supply value 0x80C0 as return value. Values are only transferred between the FM458-1 DP and S7-CPU if these SFCs return a value of 0.
- Transition of the FM458-1 DP from RUN->STOP:
When the STOP state is reached, FM458-1 DP designates all of the configured data sets, as non-available. Just like the case above, this is then detected in the user program, on the CPU side, using the return values 0x80B0 and 0x80C0.
- Behavior for POWER ON:
The configured data sets are set-up but are only released, just like at the transition from STOP->RUN, after several task cycles in RUN.

Behavior for K-bus transfer at operating state transitions

- Transition of the FM458-1 DP from STOP->RUN:
The BSEND (SFB12) on the S7-CPU side outputs an error message until the FM458-1 DP has completely established the communications administration in RUN. In the RUN state, this procedure lasts several cycles. This is signaled on the S7-CPU side in the user program using the ERROR and STATUS return values. ERROR has a value of 1 and STATUS a value of 7. This means that the partner block (in this case, the BRCV on the FM side) is in the incorrect state. ERROR goes to 0 as soon as BRCV is ready to receive data on the FM side.

- Transition of the FM458-1 DP from RUN->STOP:
As soon as the FM458-1 DP has reached the STOP state, the outputs of block BSEND (SFB12) are set as follows:
ERROR = 0 and STATUS = 7.
 - Behavior for POWER ON: (refer to STOP->RUN).
- Diagnostics data set 0 and operating states**
- Using diagnostics data set 0, FM458-DP signals whether it is in the STOP or in the RUN state. This data set can be evaluated by the user program on the S7-CPU side. The user can read diagnostics data set 0 of the FM458-1 DP, e.g. with SFC59 (RD_REC) using data set number 0. The structure of this diagnostics data set can be found under the module diagnostics info in the help or in the documentation "STEP 7 - System and Standard Functions for S7-300 and S7-400".
- The net data area from the perspective of the operating states**
- The net data area from the user program can always be written in the S7-CPU. However, data is only processed if the FM458-1 DP is in RUN.
- Diagnostics alarm**
- In HW Config, it is possible to configure the FM458-1 DP so that it generates diagnostic alarms. The reason for generating a diagnostic alarm is an operating state change. The diagnostics alarm is evaluated in the user program in OB82 (I/O_FLT).
 - When does the FM generate a diagnostics alarm:
 - Change from RUN->STOP
 - Change from STOP->RUN, if this transition was not initiated by the S7-CPU (e.g. as a result of an operator action on the PG)
 - Withdraw/insert the MMC
- Process alarms**
- It is possible to configure the FM458-1 DP in HW Config so that it may generate process alarms. In this case, block PAS7 is used on the FM to configure this function.
 - The FM458-1 DP only sends process alarms to the S7-CPU in the RUN state.

2.1.8 Technical data

Order No.	Application module FM 458-1 DP	6DD1607-0AA1 / 6DD1607-0AA2
Program memory	Usable MMC-Cards: 2, 4 or 8 MB	
Serial service interface (X1)	RS232 interface (V.24) <ul style="list-style-type: none"> Service protocol Data transfer rate 	<ul style="list-style-type: none"> DUST1 19.2 kbaud
Binary inputs (X2)	Number	8
	Electrical isolation	No (only via optional IF modules)
	Input voltage <ul style="list-style-type: none"> permissible range nominal voltage for a 0 signal for a 1 signal 	<ul style="list-style-type: none"> -1 V to +33 V 24 V -1 V to +6 V or open-circuit inputs +13.5 V to +33 V
	Input current <ul style="list-style-type: none"> for a 0 signal, typical for a 1 signal, typical 	<ul style="list-style-type: none"> 0 mA 3 mA
	Delay time per channel, max.	100 μ s
PROFIBUS DP interface (X3)	Data transfer rate	max. 12 Mbaud
Voltage, currents	Nominal voltages at 25° C	Typical current drain (typical = 2/3 max.)
	+5 V	2.2 A / 1.5 A
	Battery +3.4V	15 μ A
Power loss	Power loss, typical	11 W / 7.5 W
ambient temperature	ambient temperature	max. 40° C
		max. 50° C only in stand alone mode with the interface modules SU12, SB10 and SB61 with the cable SC64
Dimensions	Assignment, slots	1
	Dimensions W x H x D [mm]	260 x 197 x 20.32
	Weight	1.0 kg

2.2 I/O expansion module EXM 438-1

Designation	Order No.
I/O expansion module EXM 438-1	6DD1607-0CA1

2.2.1 Application and design

Application

The EXM 438-1 expansion module provides additional binary and analog I/O as well as incremental- and absolute value encoders. Fast data transfer with the FM 458 application module is realized via the internal LE bus. The power supply is obtained via the P bus of SIMATIC S7-400. It is not possible to directly transfer process data via the P bus.

To connect the 24V DC power supply of the binary inputs and outputs, terminals 9 and 10 on the SU13 interface module must be used:

- Terminal 9: 24V
- Terminal 10: M

These terminals have been designed so that the polarity cannot be interchanged.

Design

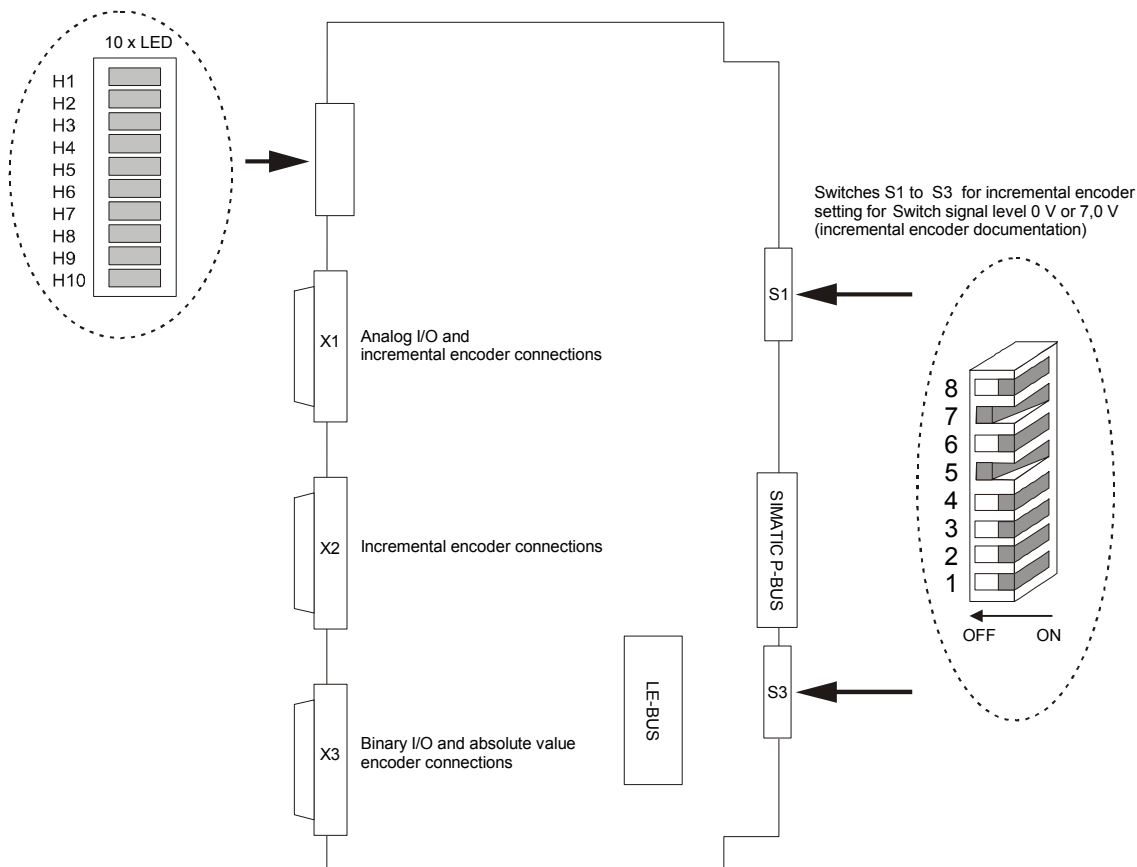

Fig. 2-4 Mechanical design of the I/O EXM 438-1 expansion module

2.2.2 Performance features

- 8 incremental encoders:
- 4 absolute value encoders (SSI or EnDat)
- 5 analog inputs
- 4 analog outputs 12 Bit (analog outputs 5 - 8)
- 4 analog outputs 16 Bit (analog outputs 1 - 4)
- 16 binary inputs, 24 V
- 8 binary outputs, 24 V
- Fanless operation up to 40° C air intake temperature (ambient temperature) possible.
- 8 LEDs which the user can configure as required

LED displays H1 to H8, when required, can be controlled using function block BIQ8 (binary output).
LEDs H9 and H10 have no function.

- LE bus

The LE bus ensures fast data transfer between the FM 458 application module and its expansion modules.

- P bus

The peripheral bus (P bus) is the parallel SIMATIC backplane bus, which only provides the power supply for the EXM 438-1.

Load Current Power Supply

The DC load current power supply must meet the following requirements:

Only a safe, isolated extra-low voltage of $DC \leq 60$ VDC may be used as the load current supply. Isolation may be implemented according to the requirements of the following, amongst other publications:

VDE 0100-410 / HD 384-4-41 S2 / IEC 60364-4-41

(as a functional extra-low voltage with isolation) or

VDE 0805 / EN 60950 / IEC 60950

(as a safely extra-low voltage SELV) or VDE 0106 Part 101.

NOTE

Ground-free operation is not possible when using the EXM 438-1.

EXM 438-1 is an "open type" and therefore only can be installed in closed switch cabinets or switch rooms.

2.2.3 Supplementary components

Interface modules All of the I/O signal cables are not directly connected to the module, but via interface modules. The interface modules are used as mechanical connecting elements (screw terminals) as well as to electrically adapt the plant/system signals and convert them (optional).

Components	Designation	Order No.
Interface module, electrical 1:1 connection	SU12	6DD1681-0AJ1
Interface module, electrical 1:1 connection	SU13	6DD1681-0GK0
Interface module, electrical 1:1 connection	SB10	6DD1681-0AE2
Interface module with electrical isolation and signal conversion	SB61	6DD1681-0EB3
Interface module with electrical isolation and signal conversion	SB71	6DD1681-0DH1
power supply connector for interface module SB10, SB61, SB71	SM11	6DD1680-0BB0

Table 2-7 Interface modules for the I/O expansion module EXM 438-1

NOTE

The operation of the EXM438-1 is only allowed with these interface modules.

The interface modules are “open type” and therefore only can be installed in closed switch cabinets or switch rooms.

For further informations about the interface modules see documentation “SIMADYN D Hardware”

Cables

The module is connected to the interface modules via the appropriate plug-in cables. Plug-in cable SC62 has five cable ends which can be connected to the appropriate number of suitable interface modules.

Components	Designation	Order No.
Connecting cable, 50-pin/5*10-pin	SC62	6DD1684-0GC0
Connecting cable, 50-pin/50-pin	SC63	6DD1684-0GD0

Table 2-8 Cables for the input/output expansion module EXM 438-1

2.2.4 Connection possibilities

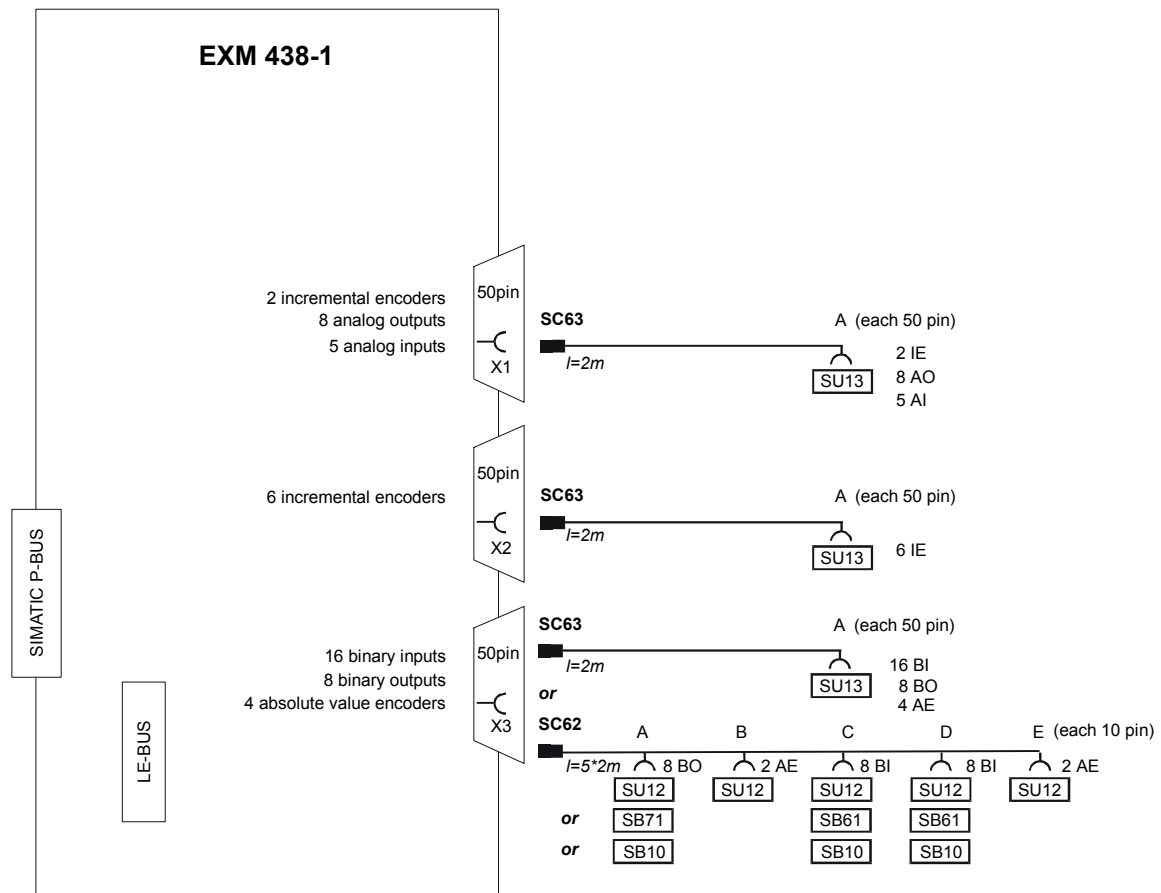

Fig. 2-5 Connection possibilities of the input/output expansion module EXM 438-1

LE-bus connection An additional expansion module (EXM 438-1 or EXM 448/EXM 448-2) can be inserted at this 5 x 24 pin socket connector.

P-bus connection The 5 x 17 pin socket connector is used to connect to the SIMATIC S7 backplane (only power supply).

**Connecting X1
with cable SC63**

The analog inputs and outputs and a part of incremental encoders are available at the screw terminals of the SU13 interface module, which is connected via cable SC63 (1:1 connection).

The screw terminal assignment at interface module SU13 corresponds to the connector assignment of X1.

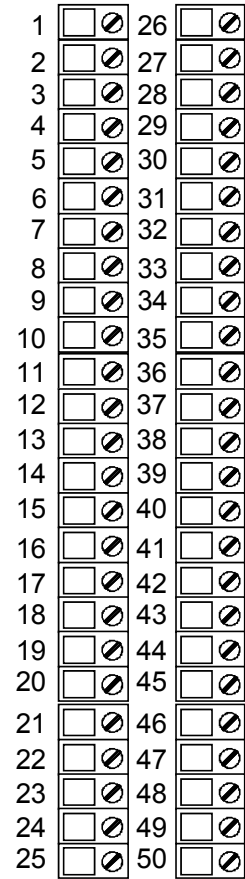

Screw terminals on SU13

PIN	Significance	PIN	Significance
1	Incremental encoder 7 track A+	26	Incremental encoder 8 track A+
2	Incremental encoder 7 track A-	27	Incremental encoder 8 track A-
3	Incremental encoder 7 track B+	28	Incremental encoder 8 track B+
4	Incremental encoder 7 track B-	29	Incremental encoder 8 track B-
5	Incremental encoder 7 track N+	30	Incremental encoder 8 track N+
6	Incremental encoder 7 track N-	31	Incremental encoder 8 track N-
7	Ground, encoder	32	Ground, encoder
8	Monitoring input 7	33	Monitoring input 8
9	-	34	-
10	Ground, encoder	35	Ground, encoder
11	Analog output 1+	36	Analog output 5+
12	Analog output 1 -	37	Analog output 5 -
13	Analog output 2+	38	Analog output 6+
14	Analog output 2 -	39	Analog output 6 -
15	Analog output 3+	40	Analog output 7+
16	Analog output 3 -	41	Analog output 7 -
17	Analog output 4+	42	Analog output 8+
18	Analog output 4 -	43	Analog output 8 -
19	Analog input 5 +	44	Analog input 5 -
20	Ground, AD converter	45	Ground, DA converter
21	Analog input 1 +	46	Analog input 3+
22	Analog input 1 -	47	Analog input 3-
23	Analog input 2+	48	Analog input 4 +
24	Analog input 2 -	49	Analog input 4 -
25	Ground DA converter	50	Ground AD converter

Table 2-9 Connector assignment of X1

**Connecting X2
with cable SC63**

The incremental encoders are available at the screw terminals of interface module SU13, which is connected via cable SC63 (1:1 connection).

The screw terminal assignment at interface module SU13 corresponds to the connector assignment of X2.

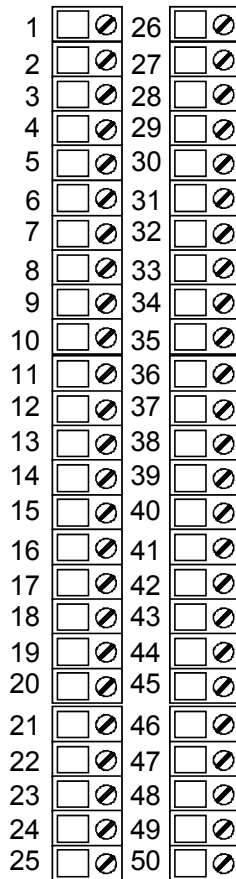

Screw terminals at SU13

PIN	Significance	PIN	Significance
1	Increm. encoder 1 track A+	26	Increm. encoder 2 track A+
2	Increm. encoder 1 track A-	27	Increm. encoder 2 track A-
3	Increm. encoder 1 track B+	28	Increm. encoder 2 track B+
4	Increm. encoder 1 track B-	29	Increm. encoder 2 track B-
5	Increm. encoder 1 track N+	30	Increm. encoder 2 track N+
6	Increm. encoder 1 track N-	31	Increm. encoder 2 track N-
7	Increm. encoder 3 track A+	32	Increm. encoder 3 track B-
8	Increm. encoder 3 track A-	33	Increm. encoder 3 track N+
9	Increm. encoder 3 track B+	34	Increm. encoder 3 track N-
10	Ground, encoder	35	Ground, encoder
11	Increm. encoder 4 track A+	36	Increm. encoder 5 track A+
12	Increm. encoder 4 track A-	37	Increm. encoder 5 track A-
13	Increm. encoder 4 track B+	38	Increm. encoder 5 track B+
14	Increm. encoder 4 track B-	39	Increm. encoder 5 track B-
15	Increm. encoder 4 track N+	40	Increm. encoder 5 track N+
16	Increm. encoder 4 track N-	41	Increm. encoder 5 track N-
17	Increm. encoder 6 track A+	42	Increm. encoder 6 track B-
18	Increm. encoder 6 track A-	43	Increm. encoder 6 track N+
19	Increm. encoder 6 track B+	44	Increm. encoder 6 track N-
20	Ground, encoder	45	Ground, encoder
21	Monitoring input 1	46	Monitoring input 4
22	Monitoring input 2	47	Monitoring input 5
23	Monitoring input 3	48	Monitoring input 6
24	Ground, encoder	49	Ground, encoder
25	Ground, encoder	50	15 V encoder power supply

Table 2-10 Connector assignment of X2

**Connecting X3
with cable SC63**

The binary inputs and outputs and the absolute value encoder are available at the screw terminals of interface module SU13, which is connected via cable SC63 (1:1 connection).

The screw terminal assignment at interface module SU13 corresponds to the connector assignment of X3.

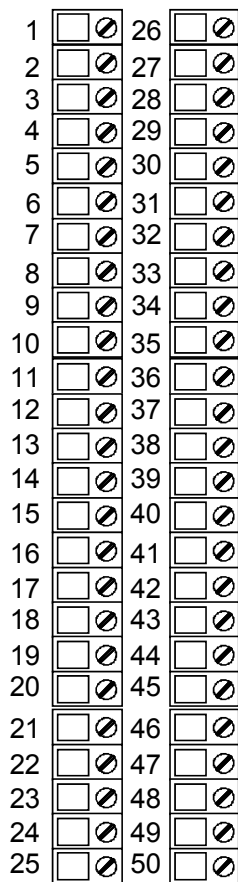

Screw terminals at SU13

PIN	Significance	PIN	Significance
1	Binary output 1	26	Binary input 1
2	Binary output 2	27	Binary input 2
3	Binary output 3	28	Binary input 3
4	Binary output 4	29	Binary input 4
5	Binary output 5	30	Binary input 5
6	Binary output 6	31	Binary input 6
7	Binary output 7	32	Binary input 7
8	Binary output 8	33	Binary input 8
9	Ext. +24V power supply	34	-
10	Ground, external	35	Ground, external
11	Abs. value encoder 1 data D+	36	Binary input 9
12	Abs. value encoder 1 data D-	37	Binary input 10
13	Abs. value encoder 1 clock cycle C+	38	Binary input 11
14	Abs. value encoder 1 clock cycle C-	39	Binary input 12
15	Ground, encoder SSI	40	Binary input 13
16	Abs. value encoder 2 data D+	41	Binary input 14
17	Abs. value encoder 2 data D-	42	Binary input 15
18	Abs. value encoder 2 clock cycle C+	43	Binary input 16
19	Abs. value encoder 2 clock cycle C-	44	-
20	Ground, encoder SSI	45	Ground, external
21	Abs. value encoder 3 data D+	46	Abs. value encoder 4 data D+
22	Abs. value encoder 3 data D-	47	Abs. value encoder 4 data D-
23	Abs. value encoder 3 clock cycle C+	48	Abs. value encoder 4 clock cycle C+
24	Abs. value encoder 3 clock cycle C-	49	Abs. value encoder 4 clock cycle C-
25	Ground, encoder SSI	50	Ground, encoder SSI

Table 2-11 Connector assignment of X3

Connecting X3 with cable SC62

Depending on the required function (signal conversion, LED display), different interface modules (max. 5) can be connected to the binary inputs and outputs as well as the absolute value encoder. For this particular case, cable SC62 must be used. This cable has five cable ends, which can be used to connect an appropriate number of interface modules. The following interface modules can be used:

Designation	Function
SB10	Direct connection (1:1 connection) of 8 binary I/O, LED, no signal conversion
SB61	8 Binary inputs, conversion 24V / 48V to 24V, LED, electrical isolation
SB71	8 Binary outputs, conversion 24V to 24V / 48V (transistor), LED, electrical isolation
SU12	10 signals can be directly connected, no signal conversion

Table 2-12 Interface modules which can be connected to X3 using SC62

Only specific signal types are available at the particular cable ends which can be used for the matching interface modules:

Module type	Terminal ¹⁾	Significance
SB10	x 5x	1:1 screw terminal connection <ul style="list-style-type: none"> • Signal • Reference potential (Ground or P24)
SB61	x 1x 5x	Binary inputs 24/48 V <ul style="list-style-type: none"> • 24 V binary input • 48 V binary input • Reference
SB71	x 5x	Binary outputs (transistor) <ul style="list-style-type: none"> • Signal • Ground

¹⁾Screw terminals X = 1 ... 8

Table 2-13 Terminal assignment of the interface modules

Terminal assignment at cable SC62, end A

X3	Designation	SU12	SB10	SB71
1	Binary output 1	1	1/51	1/51
2	Binary output 2	2	2/52	2/52
3	Binary output 3	3	3/53	3/53
4	Binary output 4	4	4/54	4/54
5	Binary output 5	5	5/55	5/55
6	Binary output 6	6	6/56	6/56
7	Binary output 7	7	7/57	7/57
8	Binary output 8	8	8/58	8/58
9	Ext. +24V power supply	9	1P	1P
10	Ground, external	10	1M	1M

Table 2-14 Terminal assignments of the interface module at connector X3, SC62 cable end A

Terminal assignment at cable SC62, end B

X3	Designation	SU12
11	Abs. value encoder 1 data D+	1
12	Abs. value encoder 1 data D-	2
13	Abs. value encoder 1 clock cycle C+	3
14	Abs. value encoder 1 clock cycle C-	4
15	Ground, encoder SSI	5
16	Abs. value encoder 2 data D+	6
17	Abs. value encoder 2 data D-	7
18	Abs. value encoder 2 clock cycle C+	8
19	Abs. value encoder 2 clock cycle C-	9
20	Ground, encoder SSI	10

Table 2-15 Terminal assignments of interface module at connector X3, SC62 cable end B

Terminal assignment at cable SC62, end C

X3	Designation	SU12	SB10	SB61
26	Binary input 1	1	1/51	1,11/51
27	Binary input 2	2	2/52	2,12/52
28	Binary input 3	3	3/53	3,13/53
29	Binary input 4	4	4/54	4,14/54
30	Binary input 5	5	5/55	5,15/55
31	Binary input 6	6	6/56	6,16/56
32	Binary input 7	7	7/57	7,17/57
33	Binary input 8	8	8/58	8,18/58
34	-	9	1P	1P
35	Ground, external	10	1M	1M

Table 2-16 Terminal assignments of the interface module at connection X3, SC62 cable end C

Terminal assignment at cable SC62, end D

X3	Designation	SU12	SB10	SB61
36	Binary input 9	1	1/51	1,11/51
37	Binary input 10	2	2/52	2,12/52
38	Binary input 11	3	3/53	3,13/53
39	Binary input 12	4	4/54	4,14/54
40	Binary input 13	5	5/55	5,15/55
41	Binary input 14	6	6/56	6,16/56
42	Binary input 15	7	7/57	7,17/57
43	Binary input 16	8	8/58	8,18/58
44	-	9	1P	1P
45	Ground, external	10	1M	1M

Table 2-17 Terminal assignments of the interface module at connector X3, SC62 cable end D

Terminal assignment at cable SC62, end E

X3	Designation	SU12
21	Abs. value encoder 3 data D+	1
22	Abs. value encoder 3 data D-	2
23	Abs. val. encoder 3 clock cycle C+	3
24	Abs. val. encoder 3 clock cycle C-	4
25	Ground, encoder SSI	5
46	Abs. value encoder 4 data D+	6
47	Abs. value encoder 4 data D-	7
48	Abs. val. encoder 4 clock cycle C+	8
49	Abs. val. encoder 4 clock cycle C-	9
50	Ground, encoder SSI	10

Table 2-18 Terminal assignments of the interface module at connector X3, SC62 cable end E

NOTE

- In order to increase the noise immunity, the ground of the analog and binary signals must be connected to the ground at the subrack through the shortest possible distance.
- You will find additional information on the interface modules in Catalog ST DA.

2.2.5 Incremental encoder settings

Switches S1 and S3 are used to change over between 15V and 5V encoders. Tracks A/VW and B/RW have a common switch, track N/- of a channel has its own switch, which can be used to set the appropriate encoder type:

- Switch open (OFF): 15 V encoder: Switching threshold = 7 V
- Switch closed (ON): 5 V encoder: Switching threshold = 0 V

Switch S1 and S3



		15 V encoders		5 V encoders	
Encoder		Switch		Switch	
Channel	Track	Numbr	Position	Numbr	Position
Encoder 1	A / VW	S1, 1	OFF	S1, 1	ON
	B / RW				
	N / -	S3, 1	OFF	S3, 1	ON
Encoder 2	A / VW	S1, 2	OFF	S1, 2	ON
	B / RW				
	N / -	S3, 2	OFF	S3, 2	ON
Encoder 3	A / VW	S1, 3	OFF	S1, 3	ON
	B / RW				
	N / -	S3, 3	OFF	S3, 3	ON
Encoder 4	A / VW	S1, 4	OFF	S1, 4	ON
	B / RW				
	N / -	S3, 4	OFF	S3, 4	ON
Encoder 5	A / VW	S1, 5	OFF	S1, 5	ON
	B / RW				
	N / -	S3, 5	OFF	S3, 5	ON
Encoder 6	A / VW	S1, 6	OFF	S1, 6	ON
	B / RW				
	N / -	S3, 6	OFF	S3, 6	ON
Encoder 7	A / VW	S1, 7	OFF	S1, 7	ON
	B / RW				
	N / -	S3, 7	OFF	S3, 7	ON
Encoder 8	A / VW	S1, 8	OFF	S1, 8	ON
	B / RW				
	N / -	S3, 8	OFF	S3, 8	ON

Table 2-19 Switch settings for 5 V- and 15 V encoders



WARNING

When the switch is closed (on), the input voltage may not exceed the voltage range of the 5V encoder, as otherwise the module would be thermally overloaded.

2.2.6 Cables for SSI and incremental encoders

SIEMENS AG has pre-assembled cables to connect encoders to the EXM 438-1. More detailed information is provided in the Catalog "Connection Systems & System Modules for SINUMERIK, SIMODRIVE, SIMOVERT MASTERDRIVES & SIMOTION, Catalog NC Z" in its current version at a time

2.2.7 Analog inputs

NOTE

The EXM 438-1 has been designed so that analog inputs can be very quickly read-in and with a high associated precision. This is the reason that the analog inputs do not have any hardware smoothing. This means that noise spikes are present on the signals at the analog inputs at the sampling instant. These are detected by the AD converter and output at the analog input block ADC.

As counter-measure, software smoothing can be provided at output Y of the ADCs. This is realized using the PT1 block which then suppresses noise and disturbances. The smoothing time constant is dependent on the sampling time that is configured in the PT1 block.

2.2.8 Technical data

Order No.	/IO expansion module EXM 438-1	6DD 1607 0CA1
------------------	--------------------------------	---------------

Analog outputs

Number	4 (Output 5 – 8)
Electrical isolation	No
Output voltage range	- 10 V to + 10 V
Output current	± 10 mA
Resolution	12 bit
Conversion time per channel, typ.	4 µs
Accuracy	
<ul style="list-style-type: none"> • Integral linearity error, max. • Gain error, max. • Offset error, max. 	<ul style="list-style-type: none"> • ± 1 LSB • ± 0.3 % • ± 24 mV
Slew rate	approx. 3.5 V/µs
Voltage output	
<ul style="list-style-type: none"> • Short-circuit protection • Short-circuit current 	<ul style="list-style-type: none"> • Yes (with respect to ground) • approx. 100 mA

Number	4 (Output 1 – 4)
Electrical isolation	No
Output voltage range	- 10 V to + 10 V
Output current	± 10 mA
Resolution	16 bit
Conversion time per channel, typ.	2 µs
Accuracy	
<ul style="list-style-type: none"> • Integral linearity error, max. • Gain error, max. • Offset error, max. 	<ul style="list-style-type: none"> • ± 1 LSB • ± 0.1 % • ± 1 mV
Slew rate	approx. 0.7 V/µs
Voltage output	
<ul style="list-style-type: none"> • Short-circuit protection • Short-circuit current 	<ul style="list-style-type: none"> • Yes (with respect to ground) • approx. 27 mA for a channel

Analog inputs

Number	5
Version	Differential inputs
Electrical isolation	No
Input voltage range	- 10 V to + 10 V
Resolution	12 bit
Conversion time per channel, max	approx. 10 μ s – 100ksps sampling rate
Accuracy	<ul style="list-style-type: none"> • Integral linearity error, max. • Gain error, max. • Offset error, max.
	<ul style="list-style-type: none"> • $\pm 1/2$ LSB • ± 0.3 % • ± 10 LSB
Input resistance	20 k Ω
Input filter	34 kHz
Incorrect polarity protection	No

Binary outputs

Number	8
Electrical isolation	No
External power supply	<ul style="list-style-type: none"> • Nominal voltage • Permissible range • Briefly • Max. current drain, without load
	<ul style="list-style-type: none"> • 24 V • 20 V to 30 V • 35 V (for max. 0.5 sec.) • 20 mA
Output voltage range	<ul style="list-style-type: none"> • For a 0 signal, max. • For a 1 signal, min.
	<ul style="list-style-type: none"> • 3 V • ext. power supply voltage, – 2.5 V
Output current	<ul style="list-style-type: none"> • For a 0 signal, min.
	<ul style="list-style-type: none"> • -20 μA
	For a 1 signal
	<ul style="list-style-type: none"> • Nominal value • Brief, permissible range, max.
	<ul style="list-style-type: none"> • 30 mA • 100 mA
Delay time	100 μ s
Switching frequency of the outputs for ohmic load, max.	6 kHz
Short-circuit protection with respect to	<ul style="list-style-type: none"> • Ground • External power supply
	<ul style="list-style-type: none"> • Yes • No
Short-circuit current, max.	250 mA
Total currents of the outputs	8 x 30 mA
Limiting inductive switch-off voltages	ext. power supply voltage +1 V

Binary inputs

Number	16
Electrical isolation	No
Input voltage <ul style="list-style-type: none"> • Permissible range • Nominal voltage • For a 0 signal • For a 1 signal 	<ul style="list-style-type: none"> • -1 V to +33 V • 24 V • -1 V to + 6 V • +13.5 V to +33 V
Input current <ul style="list-style-type: none"> • For a 0 signal, typ. • For a 1 signal, typ. 	<ul style="list-style-type: none"> • 0 mA • 3 mA
Delay time per channel, max	100 µs

Absolute value encoders

Number	4
Version	Differential inputs, RS485 signal level
Types which can be connected	
Protocols	SSI, EnDat
Data formats	Gray, binary
Data direction <ul style="list-style-type: none"> • Uni-directional • Bi-directional 	<ul style="list-style-type: none"> • SSI : uni-directional • EnDat : bi-directional
Data bits	SSI: 25 + parity EnDat: variable
Pulse frequency, max.	2 MHz
Electrical isolation	No
Input voltage	RS485 signal level

Power supply voltage for the encoders

Output voltage, typ.	13.5 V
Output current, max.	150 mA (short-circuit proof, short-current, approx. 250 mA)

Incremental encoders

The encoder types, corresponding to the technical data can be freely connected to the incremental encoder inputs.

Number	8	
Version	Differential inputs, either 15V or 5V encoder signals can be selected	Differential inputs, either 15V or 5V encoder signals can be selected
Track signals	Tracks A, B displaced through 90° and with zero pulse	Forwards, reverse track
Phase difference of the track signals, min.	200 ns	200 ns
Pulse frequency, max.	1 MHz	2.5 MHz
Noise pulse suppression	Can be configured	Can be configured
Electrical isolation	No	No
Input voltage 15 V encoder:		
<ul style="list-style-type: none"> • Permissible range • For a 0 signal • For a 1 signal 	<ul style="list-style-type: none"> • -30 V to +30 V • -30 V to +4 V • +8V to +30 V 	<ul style="list-style-type: none"> • -30 V to +30 V • -30 V to +4 V • +8V to +30 V
5 V encoder		
<ul style="list-style-type: none"> • Permissible range • For a 0 signal • For a 1 signal 	<ul style="list-style-type: none"> • -7 V to + 7 V • -7 V to -0.7 V • +1.5 V to +7 V 	<ul style="list-style-type: none"> • -7 V to + 7 V • -7 V to -0.7 V • +1.5 V to +7 V
Input current		
<ul style="list-style-type: none"> • 15 V encoder (typ., abs.) • 5 V encoder (typ., abs.) 	<ul style="list-style-type: none"> • 5 mA • 1.5 mA 	<ul style="list-style-type: none"> • 5 mA • 1.5 mA
Monitoring output (alarm reset output not available)	Not available	Not available
<ul style="list-style-type: none"> • Short-circuit protection with respect to <ul style="list-style-type: none"> • Ground • External power supply • Short-circuit current, max. 		
Monitoring inputs, Input voltage		
<ul style="list-style-type: none"> • Permissible range • Nominal voltage • 0 signal, max. • 1 signal, min. 	<ul style="list-style-type: none"> • -1 V to 33V • 24 V • -1 V to +6 V • +13.5 V to +33 V 	
Monitoring input, Input current		
<ul style="list-style-type: none"> • 0 signal, min. • 1 signal, min. 	<ul style="list-style-type: none"> • 0 mA • 3 mA 	

Voltage, currents

Rated voltages at 25° C	Typical current drain
+5 V	1.5 A

Power loss

Power loss, typ.	7.5 W
------------------	-------

ambient temperature

ambient temperature	max. 40° C
---------------------	------------

Dimensions

Number of slots required in the subrack	1
Dimensions W x H x D [mm]	24 x 290 x 210
Weight, approx.	0.76 kg

2.3 Communications expansion module EXM 448

Designation	Order No.
Communications expansion module EXM 448	6DD1607-0EA0

NOTE The EXM448 only can be installed in closed switch cabinets.

2.3.1 Application and design

Application The EXM 448 expansion module is used as communications module for PROFIBUS-DP in the master- or slave function.

Design

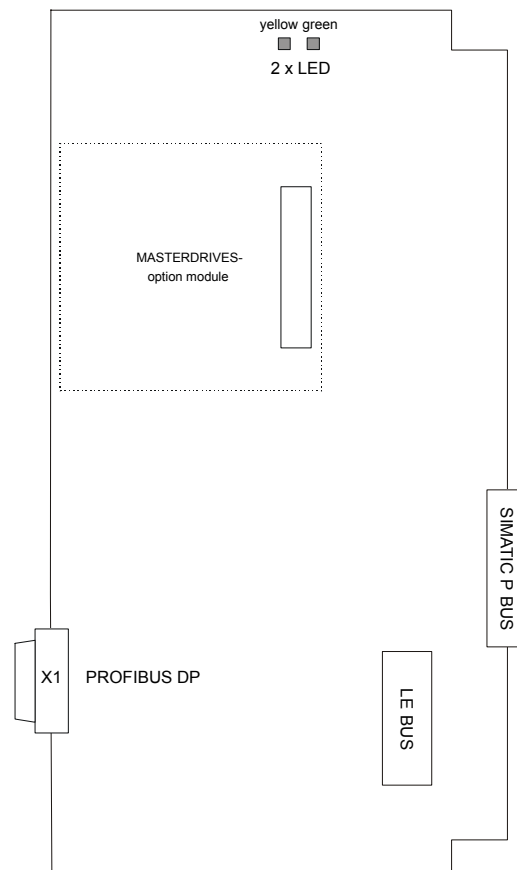

Fig. 2-6 Mechanical design of the communications expansion module EXM 448

2.3.2 Performance features

- Master- or slave interface for PROFIBUS-DP
incl. the functions "Shared Input", SYNC, FREEZE
- Data transfer rates from 9.6 kbit/s to 12 Mbit/s
- Max. 127 slaves can be connected (dependent on the configuration)
- Telegram length of max. 244 bytes per slave
- RS 485 interface for PROFIBUS-DP, floating
- RS 232 interface to parameterize the bus node
- Two displays (LED) to indicate the operating status of the communications interface and the bus activity
- DP master with COM PROFIBUS
- LE bus
The LE bus ensures fast data transfer between the FM 458-1 DP application module and its expansion modules.

P bus

The peripheral bus (P bus) is the parallel SIMATIC backplane bus, which only provides the power supply for the EXM 448.

2.3.3 PROFIBUS



WARNING

The EXM 448 manifests the following behavior at the PROFIBUS DP interface which is not in conformance with the SIMATIC system:

- If the FM 458-1 DP or the SIMATIC CPU goes to STOP within the first minute after starting, then the EXM 448 sends, for up to one minute, the last actual data to the slaves along PROFIBUS.
-

2.3.4 Connection possibilities

Connecting diagram

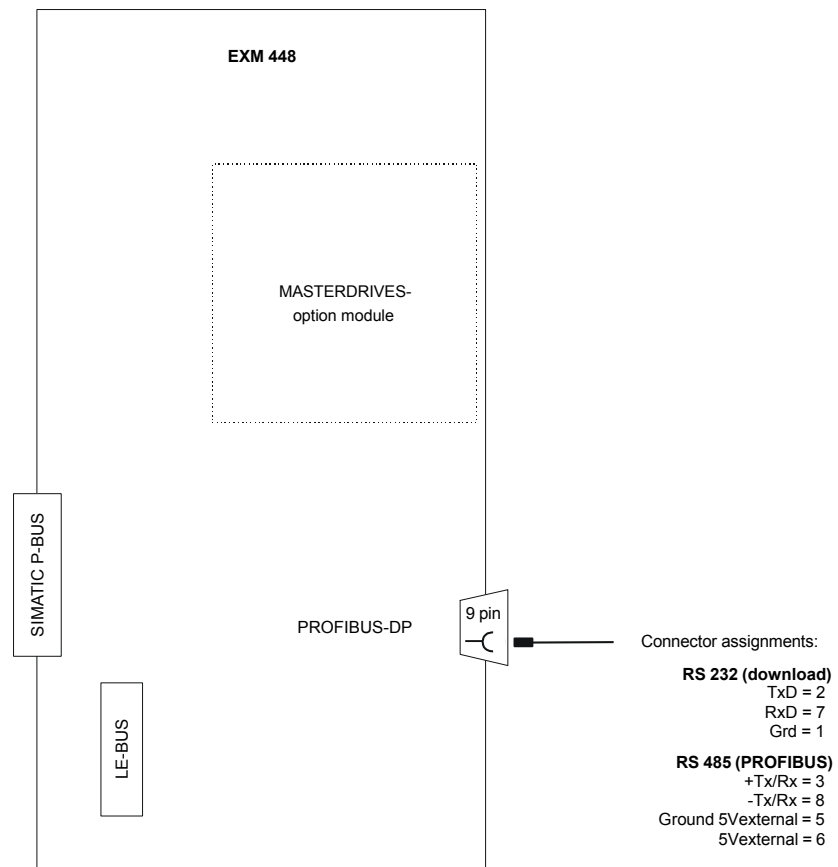

Fig. 2-7 Connection possibilities for the communications expansion module EXM 448

LE-bus connection An additional expansion module (EXM 438-1 or EXM 448/EXM 448-2) can be inserted at this 5 x 24 pin socket connector.

P-bus connection The 5 x 17 pin socket connectors is used to connect to the SIMATIC S7 backplane (only power supply).

PROFIBUS-DP (X1) The following connections are provided at the 9-pin sub-D socket:

- PROFIBUS interface with RS 485 format with electrical isolation (floating)
- Parameterizing- and diagnostics interface with RS 232 format to download the bus configuration
- 5V power supply for the Optical Link Module (OLM) with electrical isolation

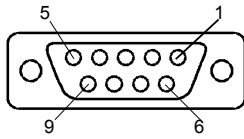

Pin	Designation	Explanation
1	RS 232: ground	for "SS52load"
2	RS 232: TxD	for "SS52load": Receive signal
3	RS 485: +TxRx	PROFIBUS: Receive- and send signal + (corresponds to data B)
4	RTS	Request to send (for OLM control; "1" when sending; as for pin 9)
5	Ground 5Vexternal	External ground; to supply OLMs
6	5Vexternal	P5 external; to supply OLMs
7	RS 232: RxD	for "SS52load": Send signal
8	RS 485: -Tx/Rx	PROFIBUS: receive- and send signal - (corresponds to data A)
9	RTS	Request to send (for OLM control; "1" when sending; as for pin 4)

Table 2-20 Connection assignment of X1 (RS232 and RS485)

NOTE

Maximal permissible load for 5Vexternal: 90 mA



Caution

5Vexternal is not short-circuit proof.

Parameterizing

The "COM PROFIBUS" program is required to use the FM 458-1 DP application module with the communications expansion module EXM 448 as master. It runs on a PC under Windows and generates a COM database.

The generated database can also be loaded via

- PROFIBUS (with PC PROFIBUS card CP5411, CP5511 card)

or

- COM1/2 interface of the PC and RS-232 parameterizing/diagnostics interface with the "SS52load" driver program in the EXM 448.

COM PROFIBUS must be additionally ordered, if EXM 448 is to be configured as master.

Designation	Order No.
COM PROFIBUS	6ES5 895-6SE12 (German)

The "SS52 load" driver program is included in COM PROFIBUS from V3.1, or it can be requested at no charge via the Siemens Intranet under the following address:

ftp://www.erlf80.asi.siemens.de/SIMADYN_D/html/treiber.htm

2.3.5 Status displays

There are two LED displays provided under the upper housing cover of the EXM 448 communications expansion module. These provide information about the actual operating status.

LED	Status	Diagnostics information
green	dark	PROFIBUS not initialized
	flashing 5 Hz	fatal error: The error code can be read at function block @CSPRO and then contact the SIMADYN D Hotline
	flashing 1 Hz	The connection to the associated CPU module is being initialized (@CSPRO): Check the configuring
	bright	Initialization O.K.
yellow	dark	No bus operation (initialization phase)
	flashing 5 Hz	Bus error/fault, e.g. short-circuit: Check the bus cable and other nodes
	flashing 1 Hz	COM database not available or inactive when downloading (only for PROFIBUS)
	flashing 0.5 Hz	CFC- and COM configuring do not match: Restricted bus operation possible (only for PROFIBUS)
	bright	Bus operation O.K.

Table 2-21 Status displays of the communications expansion module
EXM 448

NOTE

The green and yellow LEDs are only visible from the top through the cooling slots of the housing.

2.3.6 Technical data

Order No.	Communications expansion module EXM 448	6DD1607-0EA0
------------------	--	--------------

Voltage, currents	Rated voltage	+5 V
	Typical, current drain	0.3 A

Power loss	Power loss, typ.	1.5 W
-------------------	------------------	-------

ambient temperature	ambient temperature	max. 40° C
----------------------------	---------------------	------------

Dimensions	Assignment, slots	1
	Dimensions W x H x D [mm]	25 x 290 x 210
	Weight	0.85 kg

NOTE The available counter in the Plug-in module type /Peripheral addresses HWKonfig dialog has no function.

2.4 Communications expansion module EXM 448-2

Designation	Order No.
Communications expansion module EXM 448-2	6DD1607-0EA2

2.4.1 Application and design

Application

The EXM 448-2 expansion module is used as interface module for the SIMOLINK drive bus and as carrier module for an additional MASTERDRIVES option module.

If a MASTERDRIVES option module is used on the EXM448-2, then the 2nd SIMOLINK interface (X4/X5) automatically disables itself.

Design

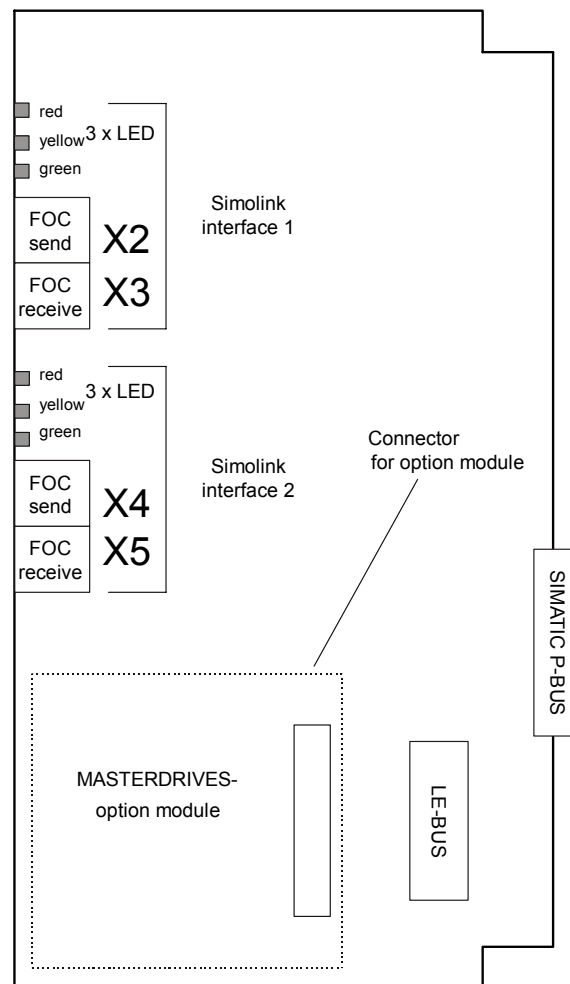

Fig. 2-8 Mechanical design of the communications expansion module EXM 448-2

2.4.2 Performance features

- 2 SIMOLINK interfaces on board (when the plug-in modules are used, the 2nd interface has no function)
 - SIMOLINK with a master function to control up to 200 MASTERDRIVES
 - SIMOLINK with slave function for a fast coupling to SIMADYN D or several FM 458-1 DP
- Optionally, additional functions can be implemented using plug-on modules.
- LE bus
The LE bus ensures fast data transfer between the FM 458-1 DP application module and its expansion modules.
- P bus
The peripheral bus (P bus) is the parallel SIMATIC backplane bus, which only provides the power supply for the EXM 448-2.

NOTE

The EXM448-2 is an “open type” and therefore only can be installed in closed switch cabinets or switch rooms.



WARNING

Light emitting diodes of the SIMOLINK interfaces are a class 1 product to EN60825-1.

2.4.3 Connection possibilities

Connecting diagram

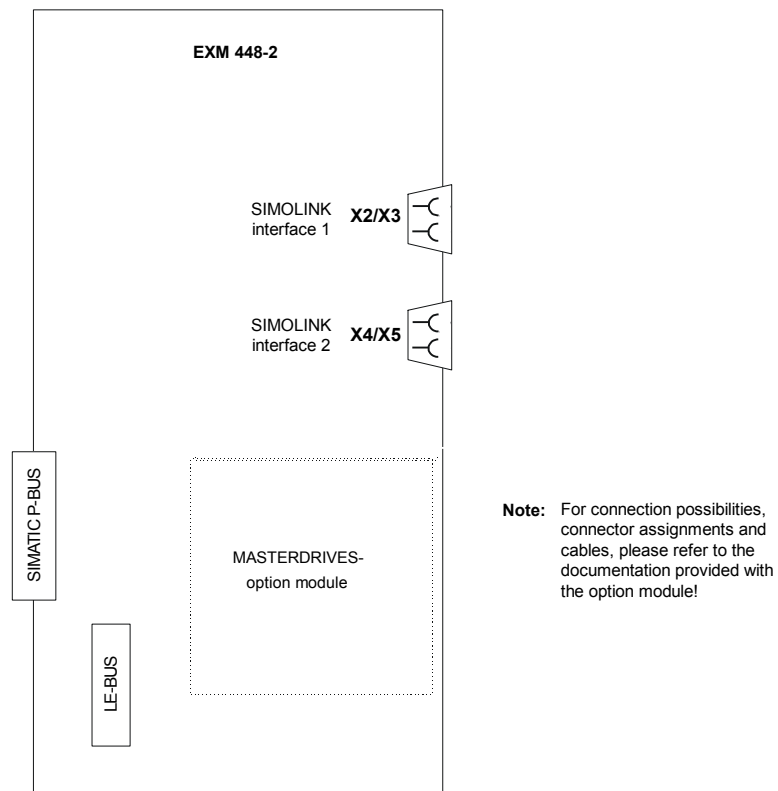

Fig. 2-9 Possibilities of connecting-up the communications expansion module EXM 448-2

LE-bus connection An additional expansion module (EXM 438-1 or EXM 448/EXM448-2) can be inserted at this 5 x 24 pin socket connector.

P-bus connection The 5 x 17 pin socket connector is used to connect to the SIMATIC S7 backplane (only power supply).

2.4.4 Status displays

The following LED display applies for each of the two SIMOLINK interfaces of the EXM448-2.

LED	Status	Diagnostics information
green	dark / bright	No net data traffic via SIMOLINK, bus cable is either not connected or defective.
	flashing	Error-free net data transfer via SIMOLINK
red	dark	Simolink interface power supply faulted
	flashing	Simolink interface in operation
yellow	dark/ bright	No data transfer with the basic unit
	flashing	Data transfer with the basic unit is ok

Table 2-22 Status displays of the Simolink interfaces of the EXM 448-2 communications-expansion module

2.4.5 Technical data

Order No.

Communications expansion module EXM 448-2	6DD1607-0EA2
--	--------------

Voltage, currents

Rated voltage	+5 V
Typical, current drain	0.5 A

Power loss

Power loss, typ.	2.5 W
------------------	-------

ambient temperature

ambient temperature	max. 40° C
---------------------	------------

Dimensions

Assignment, slots	1
Dimensions W x H x D [mm]	25 x 290 x 210
Weight	0.85 kg

Before installation in the SIMATIC subrack, you must pre-mount the FM 458-1 DP application module with all of the required options.

A max. of two expansion modules can be used together with the FM 458-1 DP application module. The following combinations are possible:

Application module	1 st expansion module	2 nd expansion module
FM 458-1 DP	None	None
	EXM 438-1	None
	EXM 448/EXM 448-2	None
	EXM 438-1	EXM 438-1
	EXM 448/EXM 448-2	EXM 448/EXM 448-2
	EXM 448/EXM 448-2	EXM 438-1
	EXM 438-1	EXM 448/EXM 448-2

Table 3-1 Possibilities of combining expansion modules

Installation sequence

When installing the FM 458-1 DP, proceed in the following sequence:

1. Remove the cover plate at the LE bus of the FM 458-1 DP and the transport protection at the LE bus connector of the EXM modules.
2. Place the modules on a flat surface and plug together.
3. Lock the modules together at the top and bottom using the connecting clips supplied.
4. Screw the cover plate on the LE bus socket of the right-hand EXM module.

The individual steps when installing options are now described.

Removing the connector- and socket cover

There is a 5 x 24-pin socket to connect expansion modules to the LE bus. They are provided on the right-hand side of the FM 458-1 DP application module. This socket is protected using a removable cover.

The following are provided on the EXM 438-1 and EXM 448/EXM 448-2 expansion modules

- on the left-hand side, the matching connector
- and on the right-hand side, a socket into which one additional expansion module can be inserted.

Unscrew the cover plate at the LE bus of the FM458-1 DP application module.

Remove the transport protection from the expansion connectors.

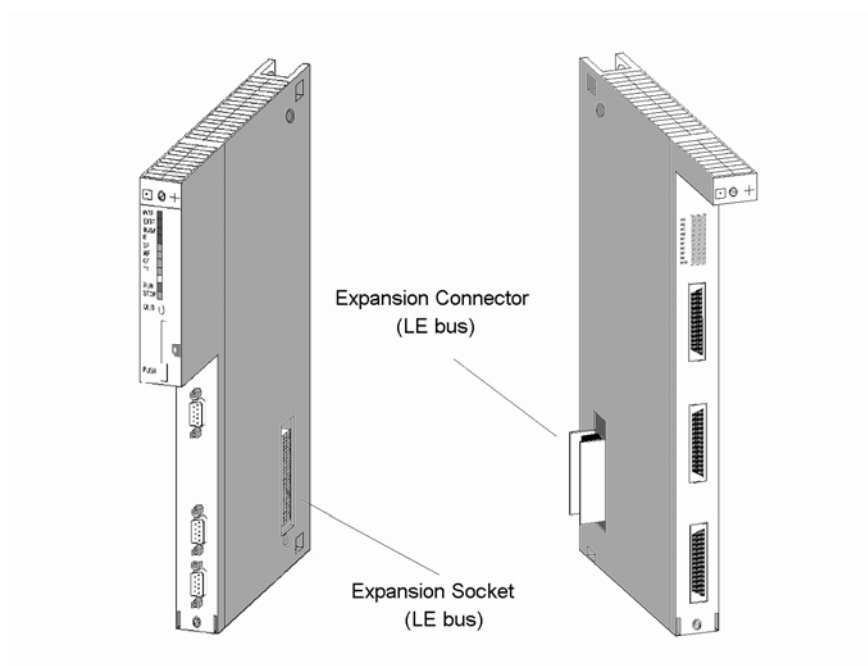

Fig. 3-2 Position of the expansion socket and connector (schematic diagram)

Removing the cover

Remove the cover before plugging the modules together. Proceed as follows:

1. Press the latch downwards (1).
2. Swivel the cover forwards (2).

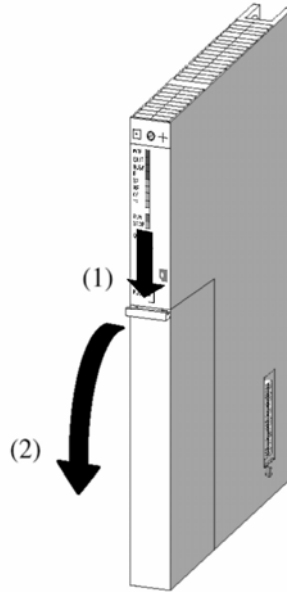

Fig. 3-3 Removing the cover

Plugging the modules together

Place the FM 458-1 DP and the first expansion module on a flat surface and carefully connect the modules, so that the connector of the expansion module is inserted, with all of its pins, exactly into the socket of the FM 458-1 DP module.

When required, insert the second expansion module in the parts which have been plugged together

Screw the cover plate onto the open LE bus connector of the right-hand expansion module.

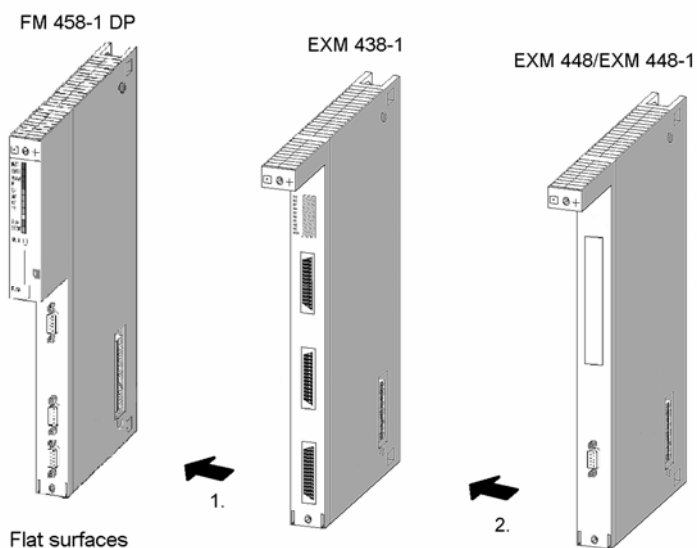

Fig. 3-4 Plugging the modules together (schematic diagram)



WARNING

The connector pins can be damaged if the modules are not correctly lined-up when connecting. The modules must be carefully lined-up with one another before plugging together.

Lock the modules together using the connecting clips

After the modules have been plugged together lock them in place using the two connecting clips provided with each EXM module so that the modules cannot be twisted or moved apart. Proceed as follows:

1. Insert a connecting clip from top between the two modules to be clipped together until the bent clip ends come into contact with the housing cover of the modules.
2. Align the connecting clip, so that the angled section of the clip is located above a grid hole of the module housing cover. The first bent clip end should be located above the 5th grid hole from the rear of the module.

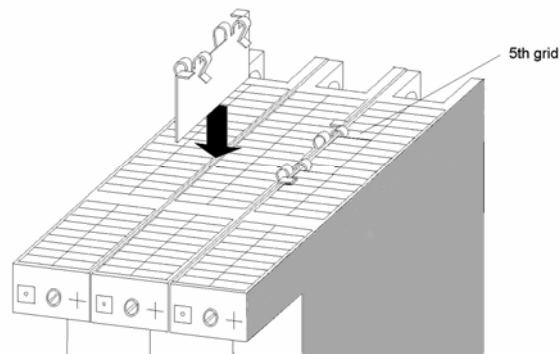

Fig. 3-5 Locking the modules together using a connecting clip (schematic diagram)

3. Then press downwards on the connecting clip at the two ends which are bent at right angles until they latch into place.
4. Repeat steps 1 to 3 at the lower side of the modules to be latched together.

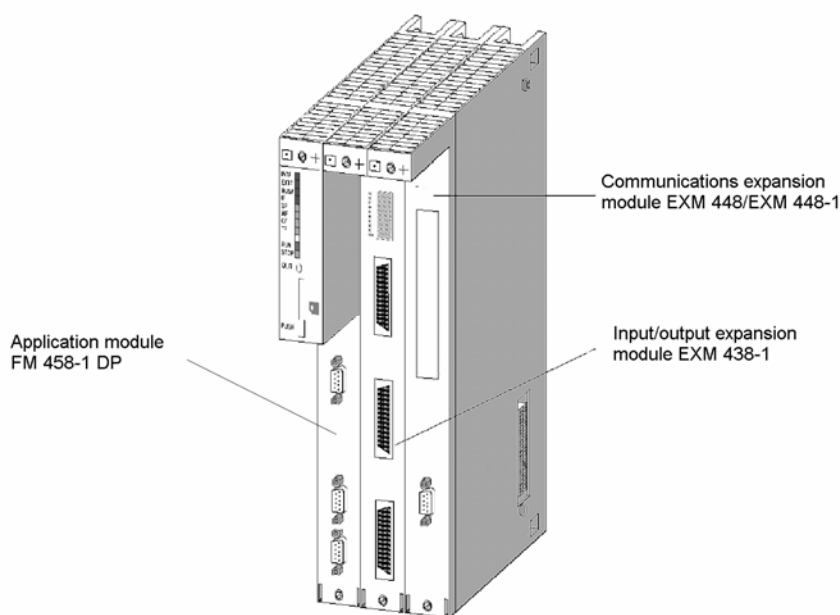

Fig. 3-6 Pre-mounted module assembly with two expansion modules (schematic diagram)

3.2 Installing the assembly into the SIMATIC subrack

NOTE

The subsequently described installation and assembly operations only refer to the FM 458-1 DP, EXM 438-1 and EXM 448/EXM 448-2 modules, which can be installed in the S7-400 automation system.

Detailed information about the mechanical design of a SIMATIC S7-400 station, as well as the installation which must be observed when locating modules in the PLC, are provided in the "S7-400 Installation Manual" (C79000-G7000-C417).

Installation sequence

Proceed as follows to install the FM 458-1 DP module (also as module assembly with options) into the subrack of an S7-400:

1. Remove the line connector at the power supply module.
2. Remove the dummy covers from the slots in which you wish to insert the modules. Hold the dummy cover at the positions marked and withdraw towards the front.
3. Insert the module (1) and carefully swing it downwards (2). If you detect some resistance when swinging the module downwards, slightly lift the module and try again.

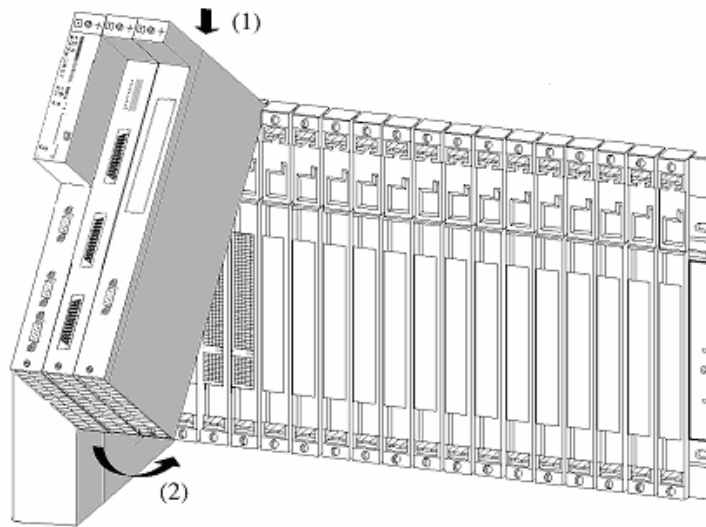

Fig. 3-7 Inserting the FM 458-1 DP module (schematic diagram)

4. Screw the module at the top and bottom, tightening the screws to 0.8 ... 1.1 Nm.
5. Re-insert the line connector at the power supply module.

3.3 Application information and noise immunity



CAUTION

The following is valid for the FM 458-1 DP application module and for the EXM 438-1 and EXM 448/EXM 448-2 expansion modules:

- Noise-immune operation is only possible if the modules are tightly screwed into the subrack.
- It is not permissible to insert or withdraw modules undervoltage.

NOTE

Additional information on EMC and ambient conditions, refer to Chapter 5 "Assembly Guidelines", or the appropriate SIMATIC S7 documentation!

4 Configuring

4.1 Freely configuring the FM 458-1 DP application module

Software components

The following software components are required to configure the FM 458-1 DP application module:

Components	Function (for FM 458-1 DP)
STEP 7 (from V5.2)	General project management and hardware configuration
CFC	Graphic Editor
D7-SYS (from V6.0)	Operating system, compiler, function block library
COM-PROFIBUS	Supplementary software, if EXM 448 is to be configured as master.

Detail informations: refer to www.siemens.com/fm458

Graphic configuring

Control related functions can be extremely easily configured using the graphic configuring interface CFC (**C**ontinuous **F**unction **C**hart). A programming language does not have to be learned.

Function blocks are taken from a library comprising approximately 250 function blocks, and placed on a page using simple drag and drop.

The block I/Os are connected with one another by clicking on an output and an input.

For inputs, which are assigned a fixed value and which are not connected, the value is specified in a parameterizing dialog box.

The configured software thus generated is compiled by the graphic configuring interface CFC and downloaded into the FM 458-1 DP application module.

NOTE

Please refer to the appropriate SIMATIC S7 Documentation and the online help of the programs for information on installation and mode of operation of STEP 7 and CFC.

Using the D7-SYS supplementary software, detailed procedures and instructions are provided in the appropriate SIMADYN D User Documentation "D7-SYS".

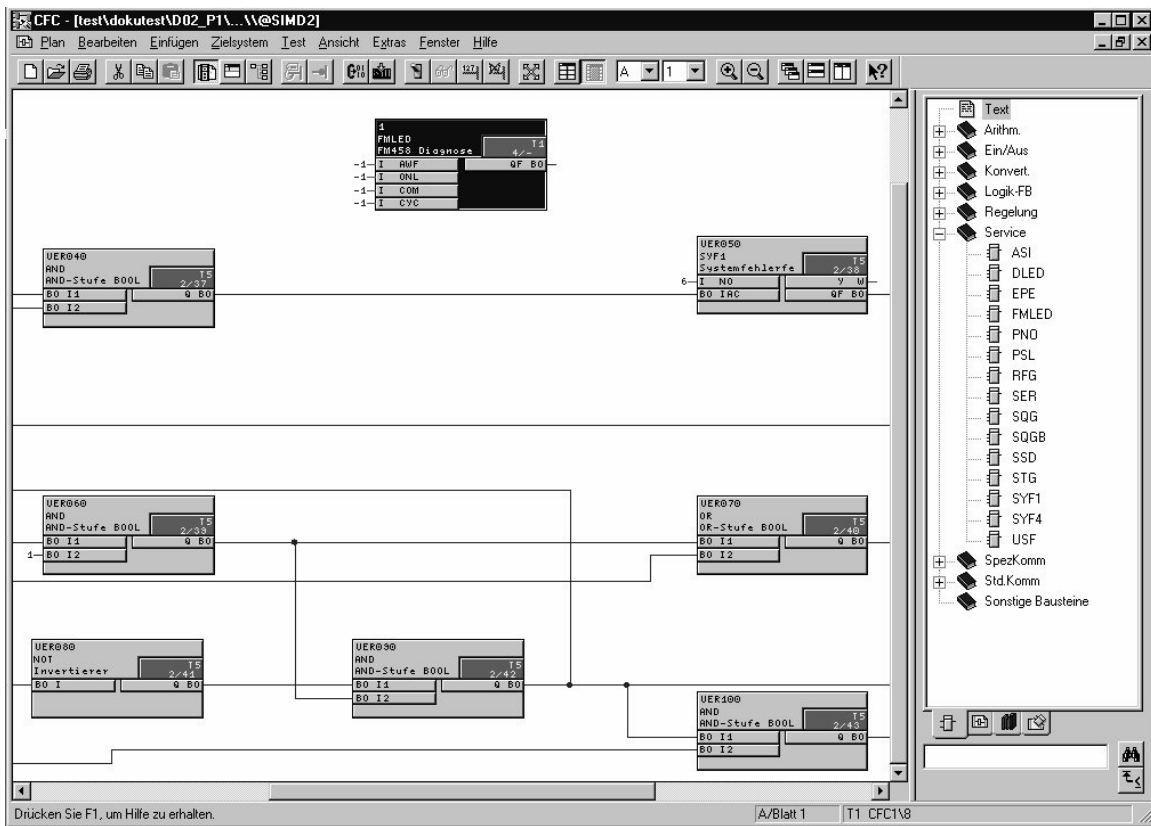

Fig. 4-1 View of the graphic configuring interface

If the program is run on the FM 458-1 DP, the following can be directly implemented on the editor interface (CFC):

- actual values displayed and changed from the FM 458-1 DP,
- connections displayed, modified, deleted and added,
- and function blocks added or deleted.

4.2 Configuring and parameterizing the components

HWConfig The hardware configuration is defined in the program section of STEP 7, in which the user indicates which components (modules) he wishes to use for his system.

Configuring Arranging subracks, modules and sub-modules in a station window is known as configuring. Subracks are represented using a configuring table, which permits, just like the "real" subracks, a defined number of modules which can be inserted.

Parameterization Properties of modules which can be parameterized, can be set using the appropriate dialog fields. The module type defines which of the parameters can be set. Before a module can be parameterized, it must be arranged in the subrack.

A dialog field, with one or several tabs appears by double-clicking on the line of the subrack with the module. This includes information and the parameters which can be set for the selected module.

These dialog fields can also be displayed by marking the module and the menu command „Edit > Object properties“ or can be displayed using the righthand mouse key "Object properties".

Procedure In order to configure and parameterize the layout, you must make the following steps in HWConfig:

1. Select the subrack (S7-400 Rack) ; it must have at least one S7 power supply unit and one S7-CPU.
2. Select the modules and submodules (FM 458-1 DP and components)
3. Parameterize the modules (define the properties)
4. Check configuration consistency
5. Save the configuration

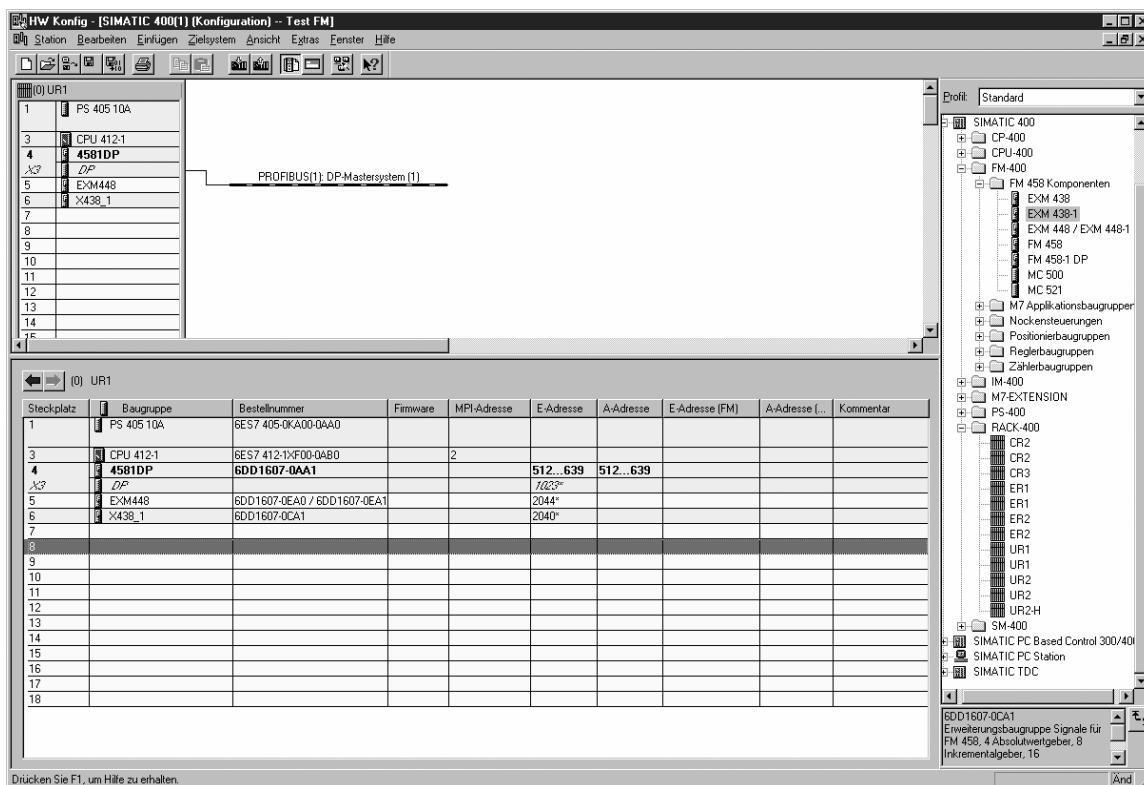

Fig. 4-2 View of hardware configuration man-machine interface (screen)

Basic operator actions

Independent of the packaging technology of a station, the configuration is always made as follows:

1. To open the sub-directories, click on the “+” symbol in the directory structure of the hardware catalog.
2. A hardware component is marked in the "hardware catalog" window.
3. The selected hardware component is dragged into the station window per drag and drop.

Example

An S7-400 station is to be configured with the following components: :

Designation	Type
Rack for S7-400 station	e.g. UR1
Power supply for S7-400 station	e.g. PS 405 10A
CPU for S7-400 station	e.g. CPU 412-1
FM 458-1 DP application module	FM 458-1 DP
Communications expansion module	EXM 448/EXM 448-1/ EXM448-2
I/O expansion module	EXM 438-1

Corresponding to the actual machine (hardware), FM 458-1 DP modules are placed in the subrack of the S7-400 station in HWConfig; this subrack must be equipped, as a minimum with a power supply and an S7-CPU.

The 400 subrack, is represented using a "configuration table", which has as many lines, as modules, which can be inserted in the actual subrack.

4.3 Coupling to the SIMATIC S7-CPU

P-bus memory

The **FM 458-1 DP** has a RAM memory (128 Kbytes) which can be used to connect it to a P bus. Data can be exchanged with **one** SIMATIC S7-CPU via this P-bus memory.

The FM 458-1 DP is **passive on the P bus**, i.e. the FM 458-1 DP cannot directly access other modules of the SIMATIC station.

There are 3 ways to transfer data to the SIMATIC CPU:

- 4 bytes can be received from the SIMATIC-CPU using a **process interrupt**
- 128 bytes can be sent and received via SIMATIC **I/O accesses**
- extremely large data quantities can be sent and received using **data blocks/sets**

Accessing EXM 438-1, EXM 448

The **EXM 438-1**, **EXM 448/EXM 448-1/EXM448-2** expansion modules can only be accessed from the FM 458-1 DP (via the FM-internal LE bus); they have no direct connection to the P bus.

Addresses

The start addresses of the I/O, under which a SIMATIC CPU can address the I/O range of the FM 458-1 DP, are configured in HW Config. The addresses for inputs and outputs can differ.

HW Config menu: *"Edit/Properties/Addresses"*

Default: **512** (decimal; for inputs and outputs)

Diagnostic interrupts

The FM 458-1 DP also sends diagnostic interrupts to the SIMATIC-CPU, independent of what has been configured, in the following situations.

- Transition into the statuses
 - "initialization error "
 - "system error "
 - "user stop "
 - "RUN"
- If the memory module is inserted or withdrawn, or is not available

4.3.1 Overview of the 3 data transfer types, FM 458-1 DP ↔ SIMATIC-CPU

Designation	Number of data	Configuring	Speed	Computation time (on the FM 458-1 DP)
1. Process interrupt	4 bytes to SIMATIC-CPU	<i>FM 458-1 DP:</i> Block PAS7 <i>SIMATIC-CPU:</i> OB40, etc.	When PAS7 is called, an interrupt is initiated on the SIMATIC CPU, e.g. OB40 (if a higher priority interrupt isn't being processed at precisely that time).	Extremely low: only for PAS7
2. Data transfer with I/O (peripheral) accesses	128 bytes in the send and 128 bytes in the receive direction	<i>FM 458-1 DP:</i> blocks S7RD, S7WR <i>SIMATIC-CPU:</i> transfer commands for the I/O (periphery)	When a block is called, data is immediately read-out of the memory or written into the memory.	Computation times of all configured S7RD/S7WR blocks: each approx. 5µs.
3. Transferring data sets/blocks	For extremely high quantities of data: max. approx. 125 data sets with each max. 240 bytes (refer below.)	<i>FM 458-1 DP:</i> "virtual connections" with blocks @CPB, CRV/CTV <i>SIMATIC-CPU:</i> system functions SFC58/59 Consistency: All of the data associated with a telegram are consistent with one another, i.e. they are transferred in a "data package".	The data associated with a telegram are read or sent when the block is called.	Computation time is required for each data set via telegram processing (approx. 30µs each CRV/CTV) and to copy the net data into/out of the P-bus memory. If extremely large data quantities are involved and there is a P-bus utilization, then a somewhat higher degree of computation time can be assumed. The data are transferred into the memory in blocks up to max. 16 bytes. The P bus must be re-assigned between the blocks, which means that the required computation time may increase.

Table 4-1 Data transfer, SIMATIC-CPU ↔ FM 458-1 DP

All of the 3 data transfer types can be used in parallel.

4.3.2 Initiating a process interrupt on SIMATIC-CPU

PAS7

Function block PAS7 initiates, when triggered, a process interrupt to the assigned S7-CPU. Supplementary interrupt info of 4 bytes is configured at the IFO input, which contains net data information.

When an interrupt is initiated, the interrupt OB, which should be configured in HW Config, is called in the SIMATIC S7-CPU. The supplementary interrupt info, taking up 4 bytes, is written into the local data of the interrupt OBs.

The start address of the input/outputs of the sending FM 458-1 DP (to be configured in HW Config; in the example 512dec = 200hex) is also saved in the local data of the OB 40.

Ste...	Baugruppe...	Bestellnummer	MPI-Adresse	E-Adresse	A-Adresse	Kor...
1	PS 407 20A	6ES7 407-0RA00-0AA0				
4	CPU 412-1	6ES7 412-1XF02-0A80	2			
5	FM458	6DD1607-0AA0		512...639	512...639	
5.1	MC521	6DD1610-0AH3				
6	EXM438	6DD1607-0CA0		2044*		
7						

HW Config

via "Edit/Properties" menu

- Select interrupt source: "Process" (or "Hardware")
- Select number of the OB (e.g. 40) as well as possibly the peripheral address(es) (Default: 512)

512dec = 200hex

```

SIMATIC S7-CPU (SL program)
OB40 "Hardware interrupt"
//Load alarm source
//(which module?):
L #OB40_MDL_ADDR
T MW20 [W#16#200]

//Load alarm info:
L #OB40_POINT_ADDR
T MW22 [DW#16#ABCD1234]

FM 458 (CFC program)
P bus memory of the FM 458
Info memory for process interrupt (4 Bytes)
0:
1:
2:
3:
PAS7
16#ABCD1234 - DW IFO
Trigger (0/1) - BO I
    
```

Fig. 4-3 Data transfer to the S7-CPU with process interrupt

4.3.3 Data transfer via I/O accesses

Application To transfer low data quantities: up to max. 128 bytes

Blocks and transfer commands Appropriate function blocks are available for each data transfer direction and for each data type to be transferred.

SIMATIC-CPU			FM 458-1 DP	
Data type	Transfer command (SL program)	Write direction	CFC function block	Data type
BYTE	T PAB abs.addr.	→	S7RD_B	BOOL
INT	T PAW abs.addr.		S7RD_I	INT
DINT	T PAD abs.addr.		S7RD_D	DINT
REAL	T PAD abs.addr.		S7RD	REAL
BYTE	L PEB abs.addr.	←	S7WR_B	BOOL
INT	L PEW abs.addr.		S7WR_I	INT
DINT	L PED abs.addr.		S7WR_D	DINT
REAL	L PED abs.addr.		S7WR	REAL

Table 4-2 Data types and the associated commands/blocks for peripheral accesses

CFC data type "BOOL"

The 8-bit CFC data type "BOOL" is represented in the SIMATIC S7-CPU as "BYTE" data type. This means that the SIMATIC S7 user must appropriately set or evaluate the decisive MSB (**M**ost **S**ignificant **B**it):

- S7-CPU: bit variable
- FM 458-1 DP: 1XXX XXXX = TRUE
0XXX XXXX = FALSE

Data save

In order to achieve high processing speeds with 32-bit accesses, the following must be ensured by appropriately configuring the FM 458-1 DP/CFC (offset, refer below) as well as programming the SIMATIC-CPU, so that

- 16-bit values (INT/WORD data types) are saved at even addresses (word limits) and
- 32-bit values (REAL, DINT data types) at addresses which are divisible by 4 (double word limits)

are saved in the two P-bus memories which are 128 bytes large.

Entering the offset for FM 458-1 DP

The FM 458-1 DP side is accessed using the S7RD/S7WR blocks, at which the offset of the data to be transferred is configured, i.e. the position within the 128 bytes.

When assigning the offset, the number of all of the values located before the block involved (blocks) and their data type (assigned memory range in bytes) are taken into account. It is especially important that possible overlaps are avoided. Gaps between individual values are not permitted (e.g. for reserve ranges).

However, the offset is not specified in the number of bytes, but as a multiple of the data type of the associated function block!

In this case, the offset, starting from an entry in bytes must be divided by 2 (for INT types) or by 4 (for REAL/DINT types) and this result must be configured at the offset input.

Using this technique, it is automatically guaranteed, that the data to be transferred is available at optimum addresses, i.e. addresses which can be quickly accessed. However, if the data is unfavorably structured, this can result in memory cells which cannot be used (refer to the example diagram below). In order to avoid this, for example, BYTE- and INT types should be individually distributed over the memory area, but should be arranged one after the other (consecutively).

Absolute address for SIMATIC-CPU

Absolute addresses are used in the SIMATIC S7 program which are obtained from the FM 458-1 DP address and the offset of the associated S7RD/S7WR block in bytes (!):

$$\text{Absolute address} = (\text{offset} \times F) + \text{FM 458-1 DP I/O address}$$

FM 458-1 DP I/O address: The start address, configured in HW Config for the I/O range of the associated FM 458-1 DP

Offset = Value at the associated S7RD/S7WR function block
F = Data type length in number of bytes:

F = 1 for S7WR_B, S7RD_B
 F = 2 for S7WR_I, S7RD_I
 F = 4 for S7WR, S7RD, S7WR_D, S7RD_D

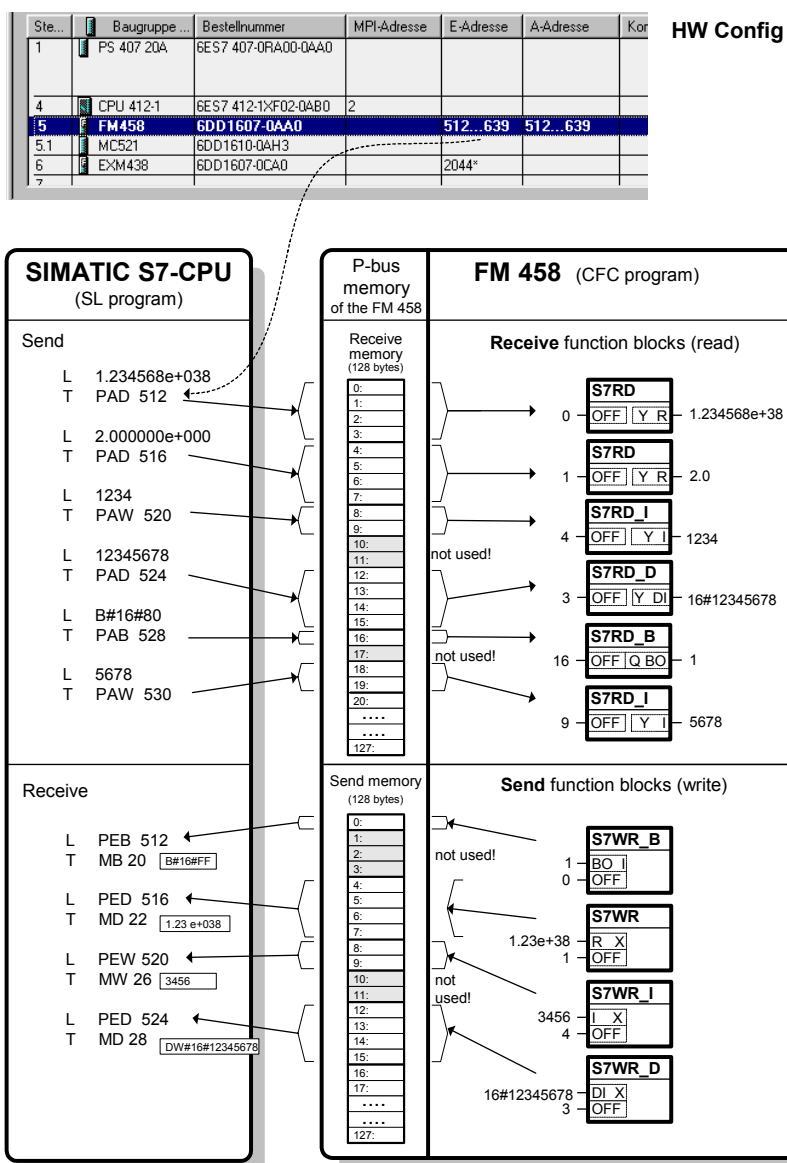

Fig. 4-4 Data transfer with peripheral accesses (I/O accesses)

4.3.4 Transferring data sets

Application	If extremely large quantities of data are to be transferred, e.g. for visualization applications (WinCC), or if data have to be transferred between SIMATIC and FM 458-1 DP for an extremely high number of drives.
Features, limit values	<ul style="list-style-type: none"> • Memory available on the P bus: 114688 bytes (0x1C000 hex), for various "data sets" (or "telegrams"). • max. 125 read and 125 write data sets • max. length per data set (telegram): 240 bytes • max. data quantity which can be transferred: For internal data management and buffer mechanisms, the following are required <ul style="list-style-type: none"> - for received data sets, 2x data set length - for sent data sets 3x data set length The sum of the required bytes for all of the write and read data sets may not exceed the above mentioned memory size of 114688 bytes!

Example:

Max. number of write and read data sets, each 240 bytes:

$$114688 \text{ bytes} / (5 * 240 \text{ bytes}) = 95.5733$$

A maximum of 95 write- and 95 read data sets, each with 240 bytes can be configured.

SIMATIC S7 access with SFC

"System Function Calls" SFC are used in the SIMATIC-CPU for data set transfer:

- write **SFC 58** data set (to the FM 458-1 DP)
- read **SFC 59** to the data set (from FM 458-1 DP)

Refer to Chapter 2.1.6 for possible return values of the SFCs when the operating state changes.

FM 458-1 DP with "virtual connections"

This coupling type is configured on the FM 458-1 DP in 3 steps:

1. Establish the coupling:
Configure a central communications block **@CPB** (from the "SpezKomm" block family) to initialize and monitor the data set coupling.
2. Define the send and receive data sets:
A function block must be configured for each data set (telegram):

CRV to receive,
CTV to send

Data/entries at the CRV/CTV connections:

– **CTS = FM4581DP.P_B**

Connection is connected to the P bus coupling:

CFC entry:

Mark the CTS/righthand mouse key/connection to the operand.

The configured module name (default "FM4581DP") appears in the selection list for the module to be connected.

– **AR / AT = 'channelname.datasetnumber'**

Any name (max. 6 characters) and separated by a point, the data set number, which corresponds to the RECNUM info/data in the SCF58/59 calls.

Value range: 2 to 127

for the send and receive data set

If several data sets are used, the channel names must be unique, i.e. they must be different.

– **CRR / CRT = 'Text'**

Enter the name for the virtual connections are which are combined to form a data set (telegram).

CFC entry:

Mark the connection / righthand mouse key / connection to operand "!"

and comprises max. 6 characters.

– **MOD = R**

P-bus communications always operates in the refresh mode.

3. Assigning process quantities to the data set:

Marked block outputs are sent and the inputs are supplied from a receive data set if they are connected to the data set/telegram via the dialog box "Insert Connection to Address". All virtual connections with this name are combined to form a data set.

A **sequence number** still has to be specified for each value (connection).

This only specifies the sequence of the associated value in the data set, but not the absolute position!

For the CFC code compilation, the data, associated with a data set, are arranged in the memory in an increasing sequence. The sequence numbers can be assigned with gaps, e.g. so that data can be easily and subsequently inserted..

Contrary to "data transfer with peripheral accesses", for virtual communications, data is always packed consecutively **without any gaps**. The configuring engineer must ensure, by sensibly assigning the sequence number, that the data are saved to word or double word limits in order to achieve a high processing speed.

The sequence number does not provide information on the address and does not specify the offset!

If an **offset of a value** in the data set (e.g. in bytes) is required for S7 program, it can be calculated from the sum of all of the previously located values, taking into account their data type (length=2 for INT, length=4 for REAL/DINT).

Different data types

SIMATIC S7 data type	FM 458-1 DP (CFC) data type	Comments
BYTE	BOOL	The MSB in the byte to be sent is decisive MSB = 1, BOOL is TRUE MSB = 0, BOOL is FALSE
REAL	SDTIME	

Table 4-3 Assignment of SIMATIC S7 and SIMADYN D data types

Ste...	Baugruppe ...	Bestellnummer	MPI-Adresse	E-Adresse	A-Adresse	Kor...
1	PS 407 20A	6ES7 407-0RA00-0AA0				
4	CPU 412-1	6ES7 412-1XF02-0AB0	2			
5	FM458	6DD1607-0AA0		512...639	512...639	I/O peripheral addresses according to the default (512) or via the "Edit/Properties" menu
5.1	MC521	6DD1610-0AH3				
6	EXM438	6DD1607-0CA0		2844*		
7						

512dez = 200hex

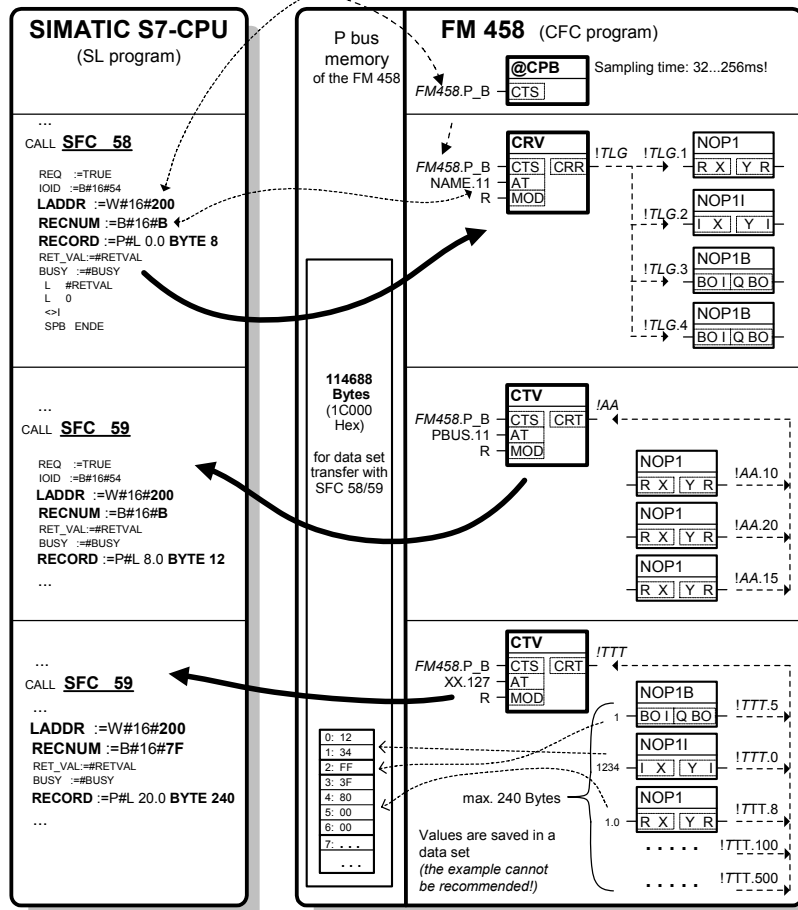

Fig. 4-5 Data transfer with peripheral accesses (I/O accesses)

4.4 PROFIBUS DP coupling

4.4.1 General basics

Characteristics

FM 458-1 DP has the following characteristics on PROFIBUS DP:

- **Master**
The FM 458-1 DP communications module can be operated on PROFIBUS both alone (stand alone) and with other masters in multi-master operation.
- **Shared input**
Each slave connected to PROFIBUS DP is assigned just one master (the parameterizing master) and at first can only communicate with this master. Additional masters can read the slave input data using the "Shared input". FM 458-1 DP supports this functionality as master and slave.
- **SYNC and FREEZE**
The outputs/inputs of several slaves can be read/written in synchronism using the SYNC and FREEZE utilities. FM 458-1 DP supports these utilities as master.
- **Equidistance (isochronous mode)**
Equidistance (isochronous mode) is a feature of the PROFIBUS DP which guarantees bus cycles which are always precisely the same length.
- **Clock-cycle synchronism**
The FM 458-1 DP and its user program can be synchronized to the PROFIBUS clock cycle.
- **Slave-to-slave communications**
The configured slaves can "directly" exchange data with one another without being configured in the FM 458-1 DP.
- **Data lengths**
A maximum of 244 bytes can be transferred in each direction and for each slave.
- **Consistency**
Data within a telegram is always consistent.

4.4.2 Configuring

4.4.2.1 Configuring the DP master system on FM 458-1 DP

The DP master of the FM 458-1 DP is configured the same as for the SIMATIC with HWConfig and when configuring the network. In this case, there are no differences than when configuring another DP master (e.g. CPU 315-2DP).

The procedure is precisely described in the Manual “Configuring hardware and configuring connections with STEP 7 V5.2” in Chapter 3, “Configuring the distributed I/O (DP)” and Chapter 8, “Networking Stations”.

This is the reason that in the following, only the special features of the FM 458-1 DP will be discussed.

4.4.2.2 Configuring the communications in CFC

Function blocks	<p>The following function blocks must be configured for a PROFIBUS DP coupling:</p> <ul style="list-style-type: none">• A central coupling block @PRODP• A maximum of one transmitter- and receiver function block per slave station• Maximum of one synchronizing function block SYNPRO can be configured• Maximum of one DPDIAG diagnostics function block and one DPSLDG slave diagnostics block per slave may be configured
Communications utility	<p>The following communication utilities are permitted:</p> <ul style="list-style-type: none">• Process data• Parameter processing of variable-speed drives
Data transfer mode	<p>Permitted data transfer mode:</p> <ul style="list-style-type: none">• Refresh• For receivers, optionally also multiple• Image (“I”), can be practically used for equidistance
Central coupling block	<p>The central coupling block @PRODP initializes and monitors the PROFIBUS DP coupling via connector X3 of the FM 458-1 DP.</p>

Entries at address connection AT, AR

Special features when making data entries at address connection AT, AR when using PROFIBUS DP:

Input sequence:

"Channelname.Adresstage1.Addressstage 2"

- **Channel name**
 - max. 8 characters
 - ASCII characters except "Point" and @
 - channel names of all transmit- and receive blocks, which access the FM 458-1 DP at the interface X3 must be different (exception for the "Multiple" data transfer mode).
 - the channel name has no special significance for PROFIBUS DP.
- Input "." after the channel name
- **Address stage 1:**
 - the slave PROFIBUS address is specified as address stage 1.
 - the slave PROFIBUS address may only assigned once for each transmit- and receive channel.
 - value range: 0, 3 - 123
 - 3...123: addressing external slaves.
- Enter "." after address stage 1
- **Address stage 2:**
 - consists of a maximum of 2 characters.
 - **1st character:** Byte order
 - "1": Standard PROFIBUS setting
The data are transferred in the "Motorola format" (most significant byte before the least significant byte).
 - "0": Exception setting
The data are transferred in the "Intel format" (least significant byte before the most significant byte). This setting can be used for communication partners whose internal data administration uses the Intel format (e. g. SIMATIC TDC).
 - **2nd character:** Optional, only receiver
"R":
The access is realized as second master which reads data. "R" can only be entered for receive channels. ("Shared input")
 - If a 2nd character is not specified, then the slave can be accessed as parameterizing master.

Examples for entries at the address connection

- AT- 'Setpoint.25.1'
 - the channel with the name **setpoint** transmits data to a **slave** with the PROFIBUS address **25**.
- AR- 'RECEIVE.117.0'
 - the channel with the **RECEIVE** name receives data from a **slave** with PROFIBUS address **117**. As an exception, data are transferred in the **Intel format**.
- AR- 'Input.33.1R'
 - the channel with the name **input** receives data from a **slave** with PROFIBUS address **33** as **(second) master which reads data**.

4.4.3 Equidistance and clock synchronism

Introduction

For the FM 458-1 DP, equidistance and clock synchronism on PROFIBUS DP is configured similar to that for a SIMATIC CPU (also refer to the Manual "Configuring the SIMATIC hardware and configuring connections with STEP 7", Chapter 3.12 "Setting bus cycles with the same length for PROFIBUS sub networks").

Special features FM 458-1 DP

For FM 458-1 DP, the user program is synchronized to the equidistant PROFIBUS DP cycle in the following way:

- Hardware configuration:
"Alarm tasks" tab of the FM 458-1 DP: Alarm source "PROFIBUS DP: Receive data ready" - define for one of the interrupt tasks I1 - I8
- Configure the user program using CFC in the defined interrupt task I1-I8 (refer to the previous text)

If it is to be guaranteed that all data come from the same PROFIBUS DP cycle, the channel mode 'Image' ('I' at the 'MOD' connection) must be configured for the transmitter and receiver blocks in this particular task.

The transmitter and receiver blocks of this task then form, for themselves, a "consistency group". It only makes sense to use this on the FM 458-1 DP for communications via PROFIBUS DP in conjunction with the "clock synchronism" functionality.

The following secondary conditions/limitations should be maintained for the transmitter and receiver:

- All of the transmitter/receiver FBs are configured in the same task,
- All transmitter/receiver FBs use the same communications interface ("CTS" parameter), and
- The same channel name is configured for all transmitter/receiver FBs (specified at the "AT" or "AR" parameters).

This means that for each task and communications interface only one "consistency group" is permitted in the transmit direction and one "consistency group" in the receive direction.

If these conditions are not carefully observed, then an appropriate error entry is made in the module diagnostics buffer.

4.4.4 SYNC/FREEZE commands

General	The SYNC and FREEZE commands synchronize the inputs and outputs of a group of slaves. The SYNPRO function block initiates these commands and supports the consistency checking process.
Consistency	The configuring engineer is responsible in guaranteeing that data is consistent. For the SYNC/FREEZE command, this involves consistency of data via all of the slaves involved. It goes without saying that the consistency of the input or output data of a slave is always guaranteed.
SYNC	<p>After initiating a SYNC command, the DP master waits for one DP bus circulating time, so that all of the slaves have received the new output values. The DP master then sends a SYNC broadcast telegram to the configured slave group. All slaves of this group then simultaneously update their buffered outputs.</p> <p>The outputs are only cyclically re-updated if the DP master sends the UNSYNC control command (EN=0 at block SYNPRO).</p> <p>Ensuring consistency: When configuring the system, it must be ensured that during a DP bus circulating time, after the SYNC command has been initiated, output data is not changed.</p>
FREEZE	<p>After initiating a FREEZE command, the DP master immediately transmits a FREEZE broadcast telegram to the configured slave group. All of the slaves of this group then simultaneously read their inputs and buffer them. This input data is then available for the SIMADYN D CPUs after a DP bus circulating time has expired.</p> <p>Input data is only transferred again cyclically from the DP slave to the DP master if the DP master sends the control command UNFREEZE (EN=0 at block SYNPRO).</p> <p>Ensuring data consistency: By suitably configuring, it should be ensured that during a DP bus circulating time, after the FREEZE command has been initiated, that the input data are not evaluated by the DP master.</p>

4.4.4.1 Configuring versions of SYNC/FREEZE

General	The terminology involved with securing data consistency are explained and various configuring versions of SYNC/FREEZE are illustrated.
Terminology	<ul style="list-style-type: none"> • Bus circulating time Cycle, in which the DP master addresses all of the slaves once. In multi-master systems, all of the masters poll their slaves. The bus circulating time is configured and computed as a result of the baud rate, number and type of slaves in STEP 7.

- **Sampling time**

This is the cycle in which the SYNPRO function block and the transmit- and receive function blocks (on FM 458-1 DP) are calculated. The sampling time is configured using CFC.

NOTE

Bus circulating time and sampling time are independent of one another.

- **Syncycle**

Syncycle is a multiple integer of the sampling time. It can be configured at input CNX of function block SYNPRO.

(Syncycle=CNX x sampling time).

A Syncycle always starts with a sampling time. A synchronizing command is always initiated by the SYNPRO function block in the system mode at the start of a sampling time.

Configuring version 1

Configuring version 1 corresponds to most of the applications:

- Generating SYNC commands.
- The data consistency over all slaves is guaranteed.
- The Syncycle is at least twice as long as the sampling time (CNX>1).
 - the length of the transmit telegrams (outputs) for each slave may not be greater than 32 bytes.
 - all transmit blocks and the SYNPRO function block must be configured in the same sampling time.
 - the SYNPRO function block must be configured before all of the transmit blocks (sequence of execution).
 - output SOK of function block SYNPRO must be connected with the enable inputs of all transmit blocks (belonging to a slave group).
 - the bus circulating time must be shorter than the Syncycle minus 1 x sampling time. When operational, it should be checked as to whether the SOK output goes to "1" once in each Syncycle, otherwise the Syncycle should be increased.

Example:

- Syncycle=3 x sampling time
- Bus circulating time=2 x sampling time
- Assumption: The SYNPRO function block calculates at the center of the sampling time (before all transmit blocks)

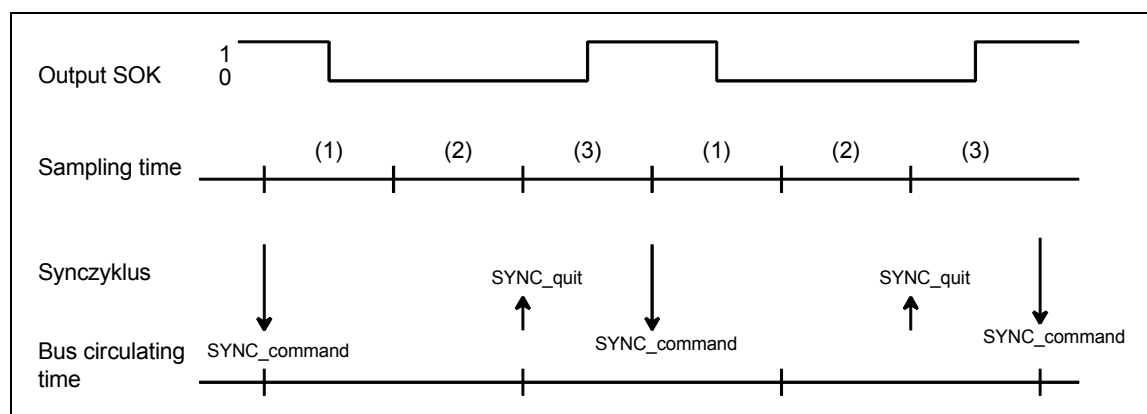

Fig. 4-6 Timing diagram, SYNC version 1

When initiating the SYNC command, the transmit blocks are inhibited (SOK=0) for two sampling times (one bus circulating time). The transmit blocks are enabled in the third sampling time after initiating the SYNC command (SOK=1).

Configuring version 2

Configuring version 2 has the highest SYNC performance:

- Generating SYNC commands.
- The data consistency over all slaves is guaranteed.
- Synccycle=sampling time (CNX=1)
 - the length of the transmit telegrams (outputs) for each slave may not be greater than 32 bytes.
 - all transmit blocks and the SYNPRO function block must be configured in the same sampling time.
 - high baud rate (>1.5 Mbaud). For lower baud rates, the time conditions can hardly be maintained.
 - the bus circulating time may only be a maximum of 50 % of the sampling time.
 - the bus circulating time must also be so low, that one sampling time expires from the start up to the calculation of the function block SYNPRO. This cannot be guaranteed, but must be checked when the system is operational.

Example:

- Synccycle=sampling time
- Bus circulating time=0,3 x sampling time
- Assumption: The SYNPRO function block calculates at the center of the sampling time (before all transmit blocks)

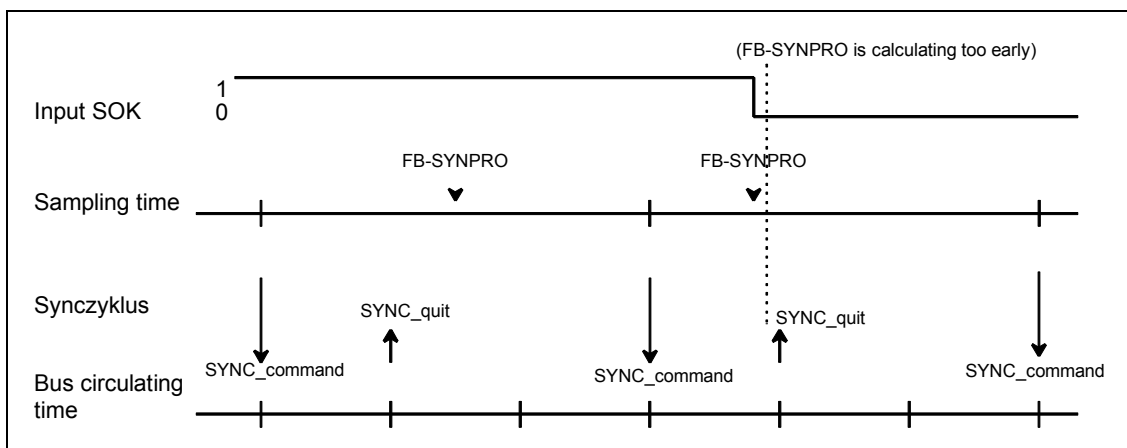

Fig. 4-7 Timing diagram, SYNC version 2

Normally, the transmit blocks are always enabled (SOK=1). If, due to time fluctuations, the SYNPRO function block is calculated before SYNC has expired (to the right in the diagram), the transmit data are not updated, but the values from the previous sampling time are transferred. The Syncycle and the data consistency are not influenced.

Instructions to achieve good SYNC functionality:

In addition to a low Syncycle, it is also necessary to have the lowest amount of jitter (time-based fluctuations) in the Syncycle. The following measures support this:

- Irregular data transfer along the DP bus should be prevented: Single-master operation; stations must not be temporarily switched-in.
- Alarm tasks should not be configured on the same FM 458-1 DP. Sampling time overruns are not permissible; this would result in a SYNC command failure or a shift by a complete sampling time.
- Configure a high baud rate and short telegram lengths (the time to poll a slave is included in the jitter.).
- Configure the SYNPRO function block and all associated transmit blocks in $T1=T0$ (basic sampling time). The SYNC command is always initiated with the basic clock cycle interrupt. It is received with more accuracy (timing accuracy) as an interrupt, initiated in the system mode.

Configuring version 3

Configuring version 3 is for generally less frequently used applications of FREEZE:

- Generating SYNC and FREEZE or only FREEZE commands.
- The data consistency over all slaves is guaranteed.
- The Syncycle is at least 300 % longer than the sampling time (CNX>1).

- the length of the transmit- or receive telegram (inputs or outputs) may not exceed 32 bytes per slave.
 - all transmit- and receive blocks and the SYNPRO function blocks must be configured in the same sampling time (on FM 458-1 DP).
 - the SYNPRO function block is configured as the last function block in the processing sequence.
 - output SOK of function block SYNPRO should be connected with the enable inputs of all (belonging to the slave group) transmit- and receive blocks.
- The bus circulating time must be less than the Syncycle minus 2 x the sampling time. When the system is operational, it should be checked whether the SOK output goes to "1" once per Syncycle; otherwise the Syncycle should be increased.

Example:

- Syncycle=4 x sampling time
- Bus circulating time=2 x sampling time
- Assumption:
The SYNPRO function block calculates at the center of the sampling time (after all of the receive- and transmit blocks)

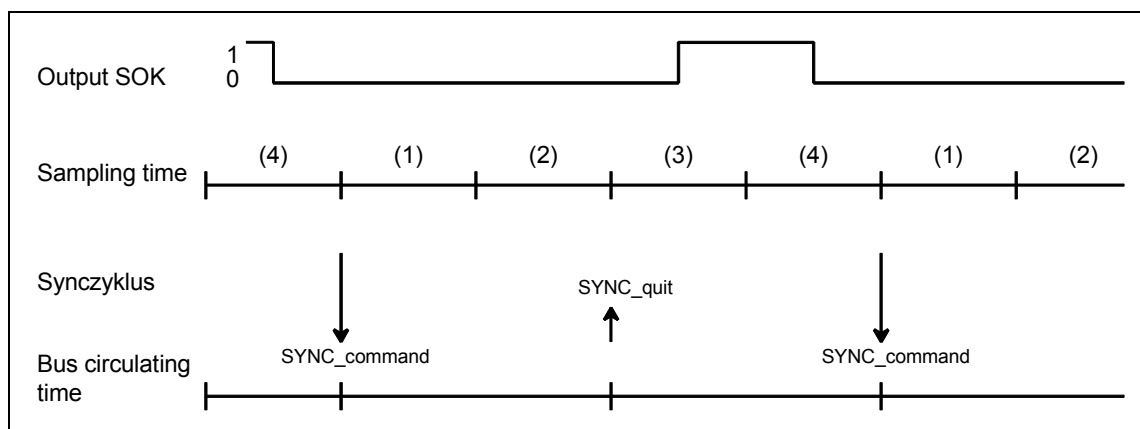

Fig. 4-8 Timing diagram SYNC version 3

After the SYNC command has been initiated, the transmit- and receive blocks are inhibited for three sampling times (one bus circulating time + one sampling time) (SOK=0). The transmit- and receive blocks are enabled in the fourth sampling time after the SYNC command has been initiated (SOK=1).

4.4.5 Commissioning/diagnostics

4.4.5.1 Diagnostics function block

General Master- or slave-specific diagnostic information can be output from PROFIBUS DP using the DPDIAG and DPSLDG function blocks.

Further information on the diagnostic data, refer to the User Documentation for the individual slaves.

Overview, diagnostic data

DPDIAG block: Diagnostics overview

- The system diagnostics provides an overview as to which slave has provided diagnostic data.
- The 4 double words are bit-coded.
- Each bit is assigned a slave with its PROFIBUS address corresponding to the following table.
- If the bit for the associated slave is set, then the slave has provided diagnostics data.

Output	Bit 16	Bit 15	Bit 14	...	Bit 5	Bit 4	Bit 3	Bit 2	Bit 1
DG1	15	14	13	...	4	3	(2)	(1)	(0)
	31	30	29		20	19	18	17	16
...
DG4	111	110	109		100	99	98	97	96
	-	-	(125)	...	116	115	114	113	112

Table 4-4 Assigning system diagnostics/data transfer list to the slave PROFIBUS address

Data transfer list

- The data transfer list provides an overview of the slaves which were involved with data transfer within a configured time.
- The double words (DL1 – DL4) are bit-coded as for the system diagnostics.
- If the bit for the assigned slave is set, then data is being transferred.

Master status

- Outputs information specific to the master:

Output	Significance
MST	Status of DP-Masters: Stop (40h), Clear (80h), Operate (C0h)
ID	Ident-No. : 80EBh for X3 on FM 458-1 DP; 8037h for SS on EXM448 / EXM448-1

Table 4-5 Information specific to the master

Block DPSLDG: Slave diagnostics

- Output of slave diagnostics data.
- The SEL data entry corresponds to the slave PROFIBUS address.
- The diagnostics data is dependent on the slave type.
- The first 16-byte slave diagnostic data are output.
- Additional slave diagnostic data can be output with SEL>1000.

Further information

on slave-specific diagnostics data, refer to the User Documentation for the individual PROFIBUS slaves.

Diagnostics data of DP slaves

Connection		
ST1	Status 1	Diagnostics acc. to the Standard 6 bytes
ST2	Status 2	
ST3	Status 3	
MPA	Master PROFIBUS address	
ID	ID No.	
D01 – D59	Device-specific diagnostics data (refer to the User Documentation for the particular PROFIBUS slaves)	

Table 4-6 Overview of the structure of the diagnostics data for DP slaves

Bits, status 1, 2 and 3

	Bit 8	Bit 7	Bit 6	Bit 5	Bit 4	Bit 3	Bit 2	Bit 1
Status 1 (ST1)	S: Slave was parameterized from another master	S: Last parameter telegram was erroneous	M: Erroneous slave response	S: Requested function is not supported	S: Diagnostics entry in the specific diagnostics area	S: Config. data don't match	S: Slave still not ready for data transfer	M: Slave cannot be addressed on the bus
Status 2 (ST2)	M: Slave entered as "not active"	(not used)	S: Slave has received a Sync command	S: Slave has received the Freeze command	S: Response monitoring activated	S: 1 (fixed)	S: Diagnostic data must be retrieved	S: Parameterization and configuring required
Status 3 (ST3)	S/M: Not all diagnostics data can be transferred	-	-	-	-	-	-	-

Table 4-7 Significance of the individual bits, status 1, 2 and 3

- **M:** Master identifies diagnostics data
- **S:** Slave identifies diagnostics data

Master PROFIBUS address (MPA)

- PROFIBUS address of the master which had parameterized this slave.

If this slave is not parameterized, then FFh is used.

Identification number (ID)

- ID to identify the slave type

All additional diagnostic data are slave-specific.

Generally (standard DP slave) the diagnostic blocks follow: Device-related, identification-related and channel-related diagnostics. Not all slave-specific diagnostic blocks must be available.

Each block is preceded by a header byte. The diagnostics block is identified by bit 7 and bit 8:

Bit 7, 8 of the header byte	Significance
Bit 7, 8= 00	Device-related diagnostics
Bit 7, 8= 01	Identification-related diagnostics
Bit 7, 8= 10	Channel-related diagnostics

Table 4-8 Significance of bit 7 and bit 8 of the header byte

Bits 1 to 6 define the following:

- For device- and identification-related diagnostics the length of the diagnostic block including the header byte, value range 2...63.
- For channel-related diagnostics, the identification number, value range 0...63.

4.4.5.2 Error class (ECL) and error code (ECO)

Outputs ECL, ECO Significance of the outputs ECL, ECO at function block @PRODP:

- **Error class>0:** An error is present. Function block @PRODP issues a communications error (CF-LED on the FM 458-1 DP is bright)

These connections are hardly of significance for users as the appropriate communication errors can be read-out through the diagnostics buffer. If you contact the hotline with fatal/difficult faults/errors, then you will be asked about the values at these connections.

4.4.6 Application example - PROFIBUS DP coupling

A project example (D7-FM_DP) is supplied with D7-SYS. which is opened in the SIMATIC Manager under **Open → Project example**, which includes a basic DP-configuration for the FM 458-1 DP.

4.5 Introduction "Pointer-based communication blocks"

Up to D7-SYS Version 6, serial or parallel data transfer operations for SIMATIC control systems were configured using the so-called "virtual communication couplings" methods (shown in CFC charts e.g.: "!VNAME.0001").

Exception: The fiber-optic cable drive coupling SIMOLINK is configured using special SIMOLINK blocks.

From D7-SYS Version 6, communication links, for example PROFIBUS-DP, SIMATIC-CPU ↔ FM 458-1 DP as well as for SIMATIC TDC or T400 and SIMADYN D can be alternatively configured using communication blocks which have become recently available.

In this case, interface data is accessed from the CFC screen using new blocks, which are inter-connected using a special pointer interface.

Both of these configuring methods (virtual interconnections and pointer-based communications) can be used together on the same hardware platform, in the same configuring (application software) and even for the same interface.

4.5.1 Principle mode of operation

Telegram blocks (CRV_P, CTV_P and S7RD_P, S7WR_P) allow access to the receiving or to the sending data blocks (telegrams) by providing a pointer to the particular data block.

This pointer is connected to read/write blocks (DRD..., DWR...). Together with an offset, a write block can save the data at its input connection at the required location in the buffer. A read block then retrieves the appropriate data from the specified location of the receive buffer and makes it available at its output.

This means that in principle, a virtual interconnection is replaced by a (read/write) block and a "normal" CFC connection.

4.5.2 Applications

Large data quantities

Pointer-based communications are especially advantageous where large amounts of data are involved. For large amounts of data, it is simpler and faster to configure and change and interconnections are more flexible.

Access to the I/O area (P bus) for FM 458-1 DP

128 bytes can be transferred from the FM 458-1 DP to the S7-CPU in each direction via the I/O area of the P bus.

Using the new S7RD_P/S7WR_P blocks, all 128 bytes can be copied into a buffer using a block and that with an optimized computation time. This buffer can then be accessed flexibly using read/write blocks via the pointer interface. Indexed access is also possible

Sub-areas can also be accessed using offset and length data.

Saving data in a data block

Data can be saved in a data memory which can be universally used. This data memory can then be accessed using read/write blocks via a pointer interface. Several similar buffers can be set-up in this data block. This means, for example, that recipes can be easily saved and called-up.

4.5.3 Features of pointer-based communications

- When generating CFC charts, the configuring time and costs are reduced, especially if very many virtual connections had to be generated.
- Connections to the telegram data can be newly inserted and changed online (pointer, buffer offset).
- Communication connections can be copied with or within chart blocks and centrally changed with them. This means that it is especially simple and quickly to configure, for example, similar communication links to a large number of drives.
- Telegram buffer data can be accessed indexed using 2 offset data. This means that extremely simple modular programs (e.g. chart blocks) can be generated and used.
- Larger data quantities can be transparently processed (e.g. blockwise) (copied), e.g. using the copy block CPY_P in data block DB_P.
- For FM 458-1 DP:
 - using "B-Receive" (BRCV) high quantities of data can be transferred from the S7-CPU to the FM 458-1 DP via the K bus.
 - 128 bytes can be simply configured and quickly transferred with low computation overhead via the I/O area of the P bus.
- A special read/write block is available for every data type (BYTE, INT, DINT, REAL).
- Before accessing REAL data, the type is checked.
- These configuring possibilities can be principally used for all of the SIMATIC control system platforms. This means FM 458-1 DP, SIMATIC TDC, T400 and SIMADYN D. The reason for this is that block processing is independent of the subordinate (secondary) hardware.

For all platforms and interfaces of the SIMATIC control systems

- For the same reason, this type of block communications can be principally used for all types of serial and parallel data transfer routes, where today "virtual communications" are used.

4.5.4 Associated function blocks

The blocks which can be used are arranged under the family names "ZeigrKom" or "PointCom" in the CFC block Catalog.

In order to be able to simply identify and easily assign to this block group, the blocks, whose function already corresponds to existing blocks, and which now output a pointer for this application, have a "_P" (pointer) at the end of the name.

Type name	Function
CPY_P	Copying buffer areas
CRV_P	Telegram block, receive (interface processing)
CTV_P	Telegram block, send (interface processing)
DB_P	Data block
DRD	Data Read REAL
DRD_D	Data Read DINT
DRD_I	Data Read INT
DRD_8	Data Read 8*REAL
DRD_8D	Data Read 8*DINT
DRD_8I	Data Read 8*INT
DRD_BY	Data Read BYTE
DWR	Data Write REAL
DWR_D	Data Write DINT
DWR_I	Data Write INT
DWR_8	Data Write 8*REAL
DWR_8D	Data Write 8*DINT
DWR_8I	Data Write 8*INT
DWD_BY	Data Write BYTE
S7RD_P	Receive 128 bytes via a P bus (only for FM 458-1 DP)
S7WR_P	Send 128 bytes via a P bus (only for FM 458-1 DP)
BRCV	Block data receive via S7 connection (only for FM 458-1 DP)

4.5.5 Pointer interface

For pointer-based communications, **a pointer is transferred to the telegram data buffer** between the blocks involved:

This pointer is actually a pointer which includes a structure, which in addition to the pointer to the net data also has information for monitoring purposes. This data includes, for example, the sampling time, block class, byte/word swap. It has the connection comment "ZeigPuffer".

4.5.6 Configuring information and instructions

- The telegram blocks as well as the read/write blocks must be configured in **the same sampling time** in order to ensure consistency (this is checked when initializing).
- **Offset data** must be carefully entered.
 - a) For pointer-based communications, the configuring engineer must precisely observe the offset (in bytes) of the 16-bit value (INT) or 32-bit value (REAL, DINT) to be addressed.
 - b) The offset must always be smaller than the buffer size. Before accessing buffer data, a check is made as to whether the area (range) has been exceeded because of an offset which has been set too high.
- If data is transferred to a PROFIBUS-DP station or to a SIMATIC CPU, then bytes (for INT) and, where relevant, words of the value to be transferred (for REAL, DINT) must be swapped. The read/write blocks have a "Swap" connection – SWP – for this specific purpose.
- In order to transfer telegrams via an interface, initially, it is sufficient to just configure the telegram block with the appropriate lengths data (CRV_T, CTV_P and S7RD_P, S7WR_P). Read/write blocks still don't have to be configured. This means that the interface can be tested or the computation time load through the interface configured using, for example, few resources.

4.5.7 Examples of CFC screenshots

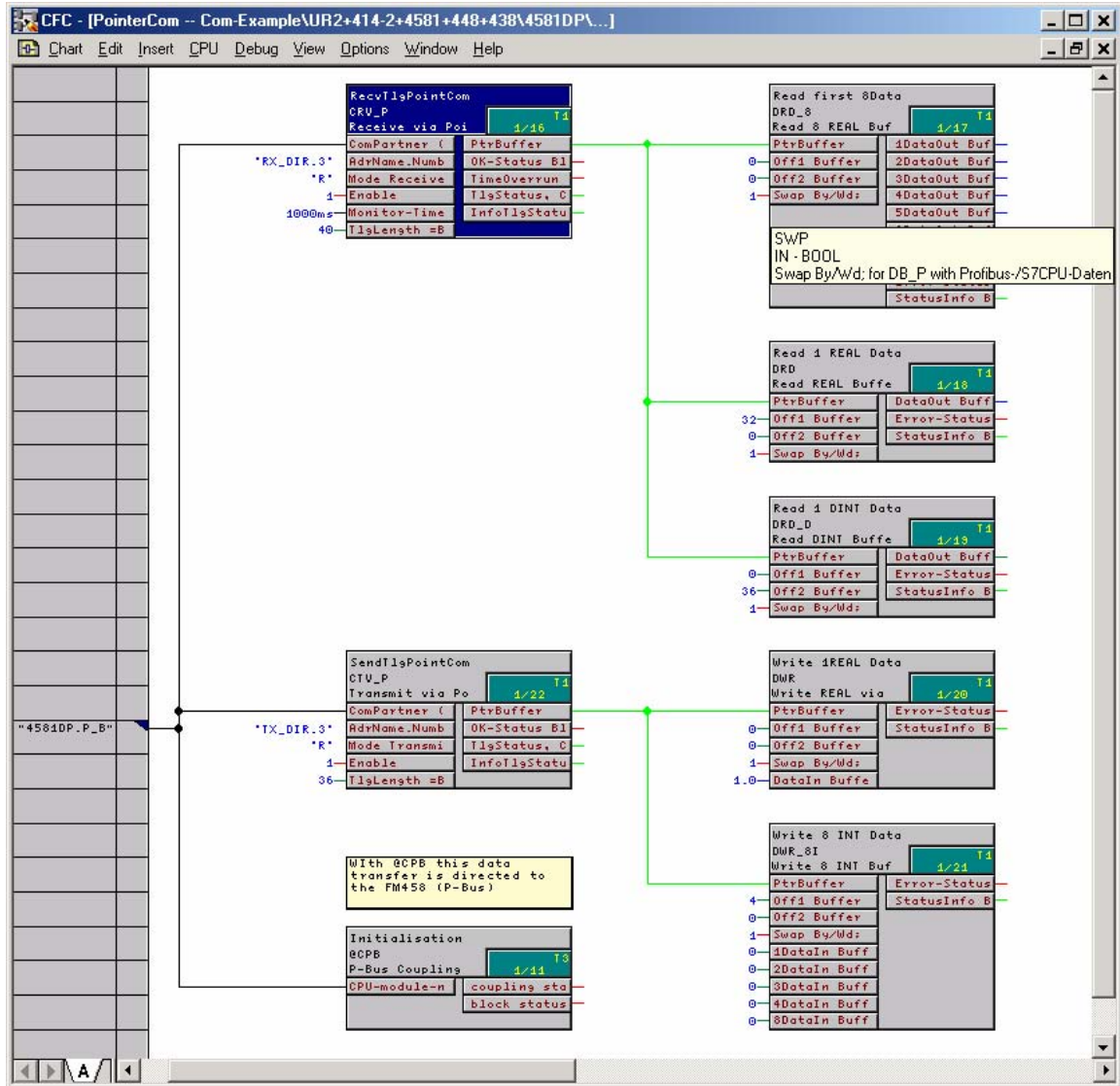

Fig. 4-9 CFC screenshot: Data transfer with telegram blocks and read/write blocks; here, for the interface P bus of the FM 458-1 DP (@CPB); bytes/words must be swapped due to the data management on the SIMATIC-CPU: SWP(Swap)=1

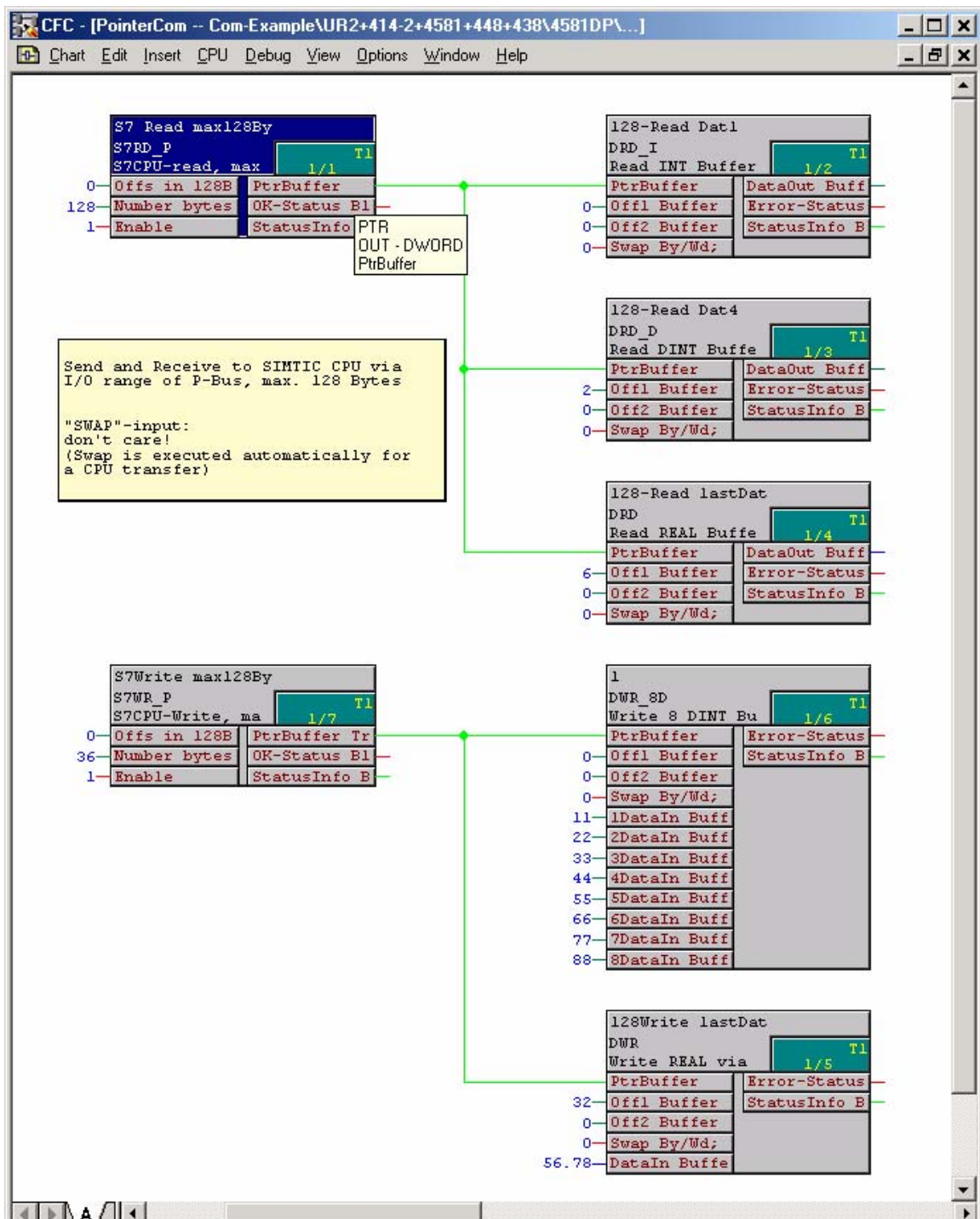

Fig. 4-10 CFC screenshot: Data transfer SIMATIC-CPU ↔ FM 458-1 DP via P bus I/O area

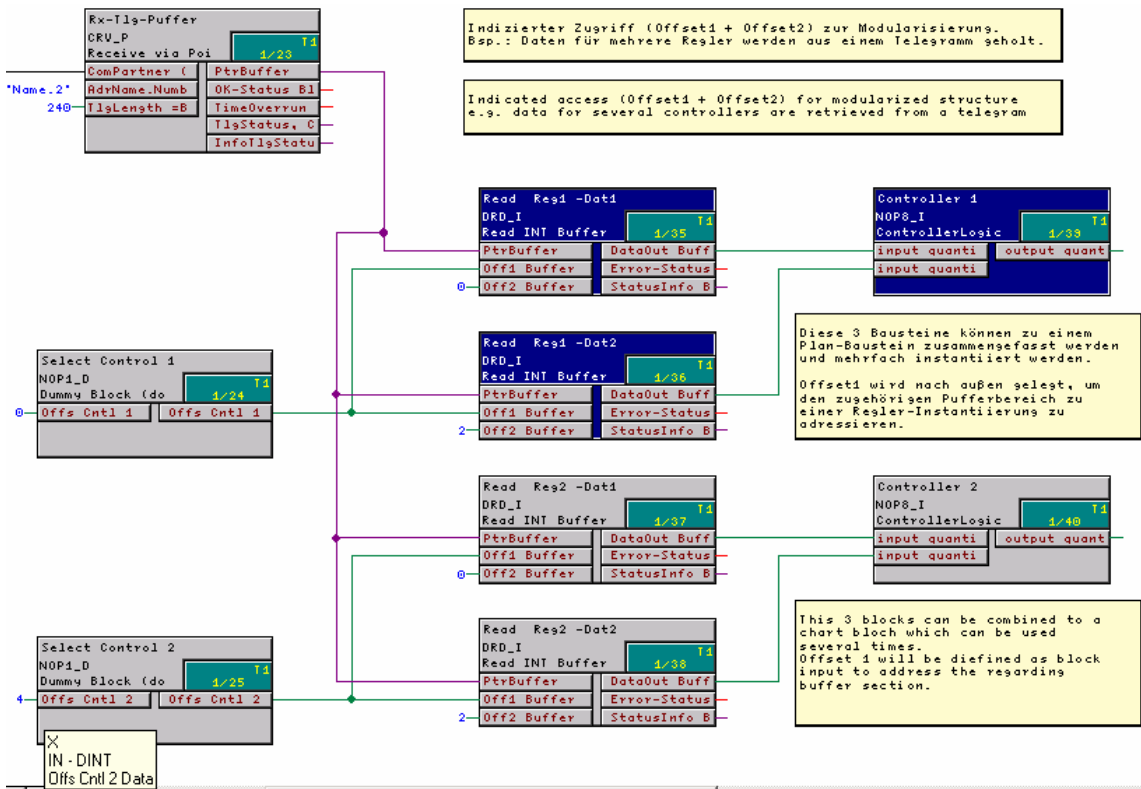

Fig. 4-11 CFC screenshot: Indexed addressing of the telegram data with 2 offsets

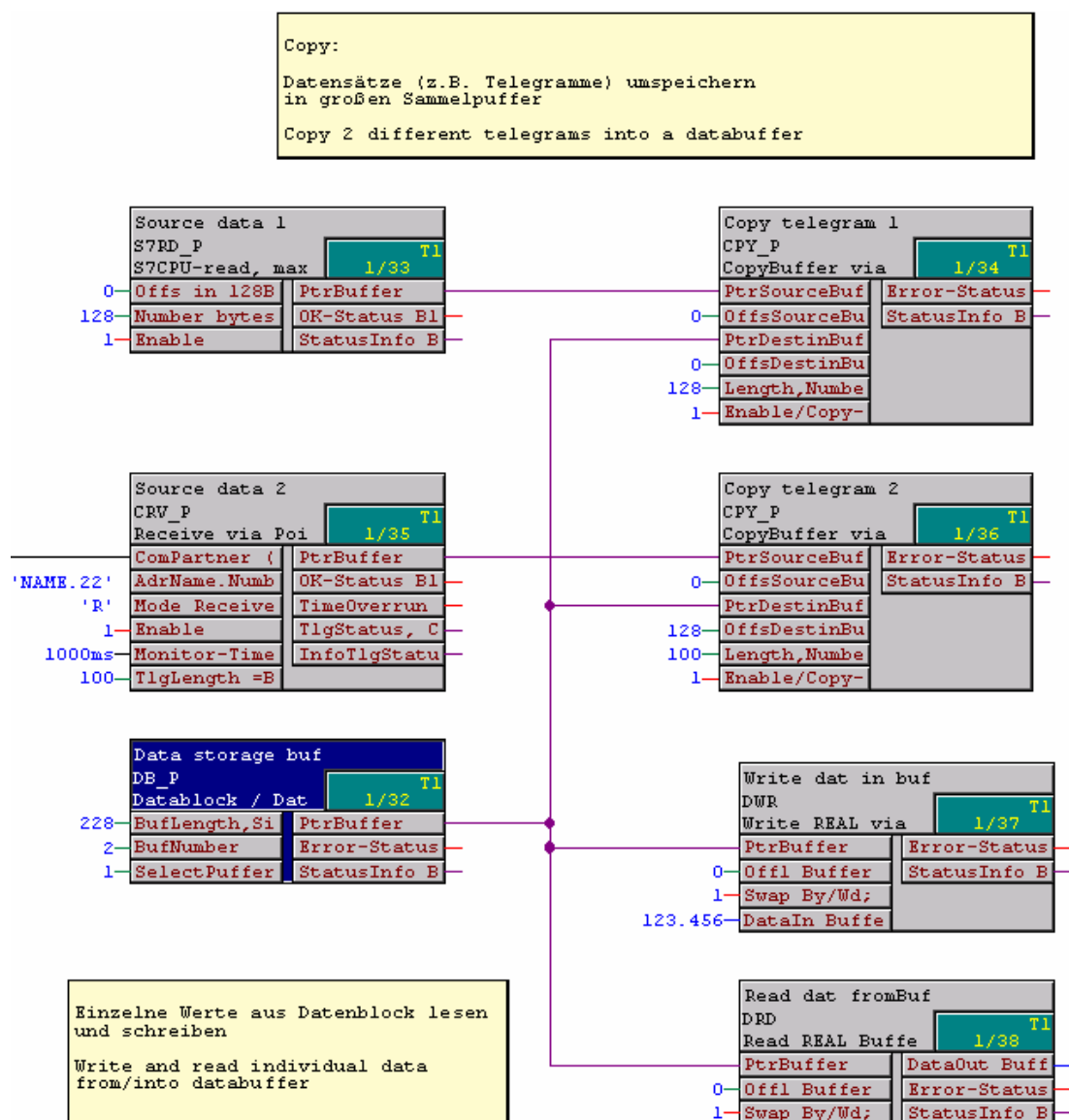

Fig. 4-12 CFC screenshot: Re-saving 2 received telegrams in a data block and single accesses to the data memory

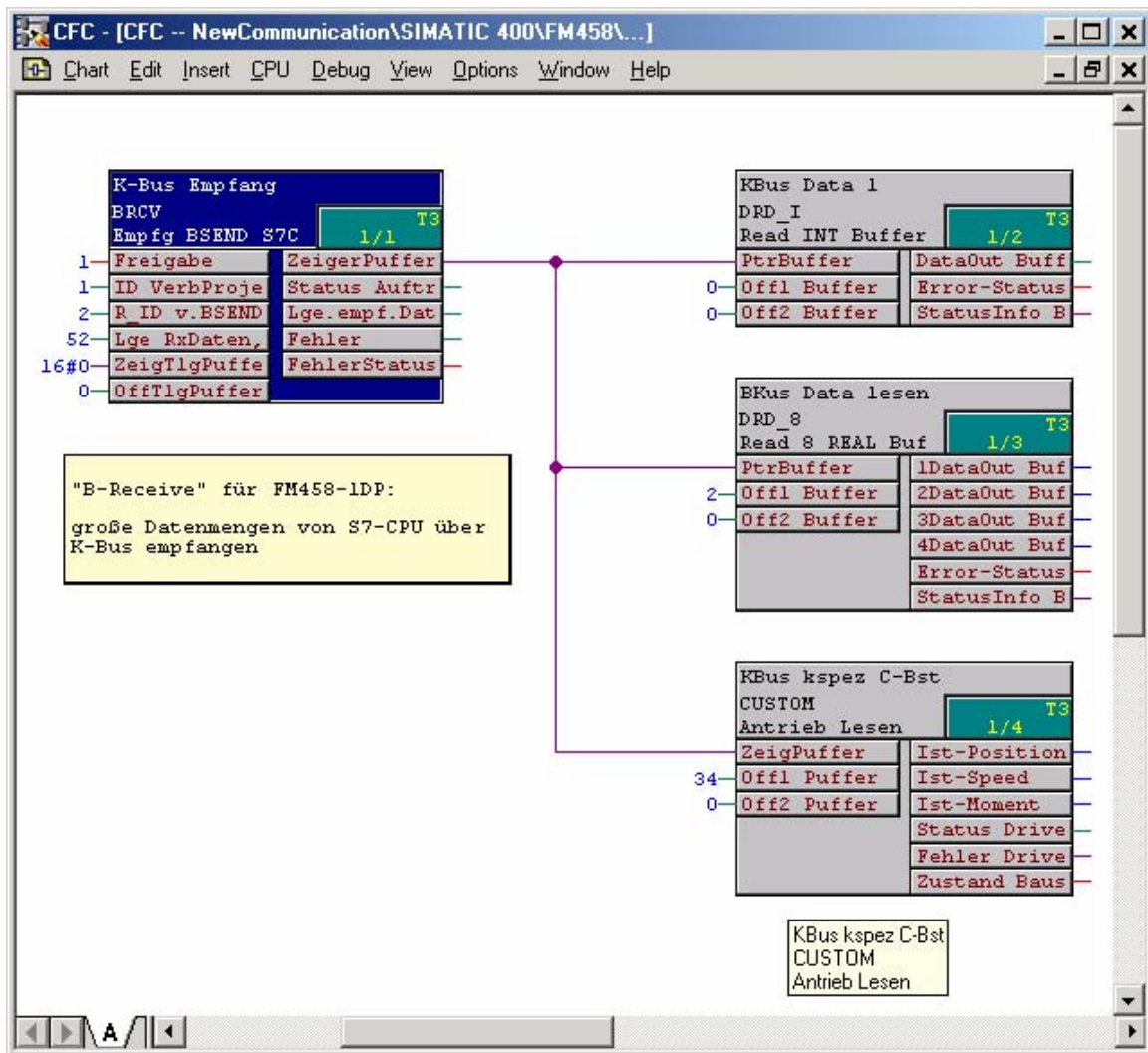

Fig. 4-13 CFC screenshot: Large data quantities received from a SIMATIC CPU via K bus using BRCV

4.6 SIMOLINK drive coupling

4.6.1 Basic information

Introduction	<p>SIMOLINK (Siemens Motion Link, SL) is a digital, serial data transfer protocol using fiber-optic cables as data transfer medium.</p> <p>The SIMOLINK drive coupling has been developed for extremely fast and/or rigid cycle transfer of process data (setpoints, actual values, control and status information)</p> <ul style="list-style-type: none">• between drives (dispatcher, transceiver)<ul style="list-style-type: none">- SIMOVERT MASTERDRIVES MC/VC, or- SIMOREG DC-MASTER or• between drives and a higher-level automation system (SL master)<ul style="list-style-type: none">- SIMATIC S7-400 station with FM 458-1 DP and EXM448-1/ EXM 448-2 or- SIMADYN D subrack with PM5/6 and ITS�• between automation systems (SL master, slave/s)• Where all of the connected nodes are synchronized (SYNC telegram) to a common system clock.
Application	<p>By transferring a time-equidistant and jitter-free SYNC telegram, SIMOLINK allows high-dynamic response and all of the connected individual drives move in absolute position synchronism (e.g. virtual shaft).</p>
Features	<ul style="list-style-type: none">• Max. 201 active nodes (SL master, dispatcher and transceiver, passive nodes include switches and cable concentrators)• Bus cycle: Time between two SYNC telegrams, i.e. the circulating time in the ringbus• SYNC telegram: All of the connected nodes are synchronized after the telegrams were sent• Telegram: 32-bit word (double word), occupies one channel for each piece of process data.• Nodes read and write their data once every bus cycle.

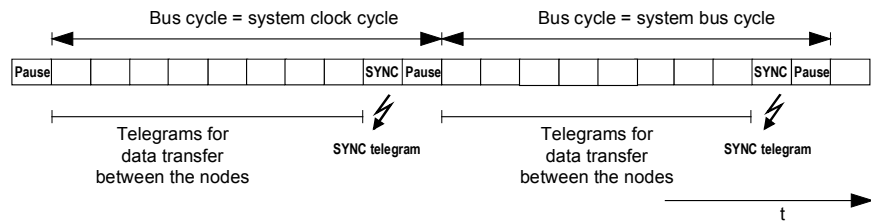

Fig. 4-14 SIMOLINK telegram data transfer

- Telegram runtime: $6.36 \mu\text{s}$
- All of the telegrams are sent immediately one after the other.
- For instance, for a selected bus cycle time of 0.6 ms, the SL master can transfer
 - one double word each to a max. of 91 slaves/transceiver, or
 - 4 double words each to a max. of 22 slaves/transceiver
- The remaining times are intervals where a telegram is not sent (NOP).
- Master-slave process data transfer:
 - up to 200 slaves/transceiver can be addressed with address gaps
 - up to 8 double words individually for each slave/transceiver
 - own process data for each slave/transceiver
- Dispatcher transceiver process data transfer:
 - up to 200 consecutively addressed transceivers
 - up to 8 double words
 - the same number of used channels for dispatcher and transceiver (nodes with a max. number of double words defines the number of channels for all)
- Data transfer rate: 11 Mbit/s
- Bus topology: Fiber-optic cable ring, each node as signal amplifier
- Max. distance between two nodes:
 - 40 m for plastic fiber-optic cables, or
 - 300 m for glass fiber-optic cables.

4.6.2 Application with master-slave process data transfer

The automation system with SIMOLINK interface is generally configured as the SL master. Whereby, all of the other coupling nodes are set as slaves/transceiver (refer to MASTERDRIVES option module SLB SIMOLINK).

The number of channels used for each slave/transceiver is defined by the SIMOLINK function blocks (connections CTV, CSV).

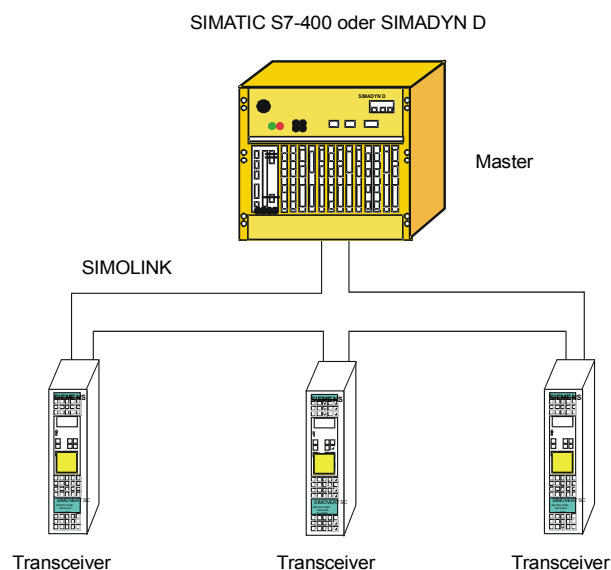

Fig. 4-15 Application example for master-slave process data transfer

Master

- The SL master can read and write into all of the channels of all of the slaves/transceiver.

Configuring data:

Function block @SL: MOD connection = 1...5 or 10
For each slave: e.g. one SLSVAV

Slave

- Each slave can read all of the channels and write into a max. of 8 (**own!**) channels.

Configuring data:

Function block @SL: MOD connection= 0
For each read channel: e.g. one SLAV
For each write channel: e.g. one SLSV,
Connection, FSL: Slave's **own** address
Connection, NSL: 1

Slave-to-slave data transfer

- In order to transfer data from slaves/transceivers to slaves/transceivers which are physically located in front in the ring, in the same bus cycle, the slave-to-slave communications setting must be used.

Configuring data:

Function blocks SLAV and SLDIS: Connection QV = 1

4.6.3 Applications and modes which should be set

Various SL master, dispatcher and slave modes can be set by appropriately configuring SIMOLINK.

For **position-synchronous** actual value sensing and setpoint input (e.g. “virtual shaft” for printing or packaging machines), the **jitter-free** (equidistant in time) modes should be set

- External mode (Mode 4),
- Interrupt automatic mode (Mode 3) and
- External cyclic mode (Mode 5)
- Cyclic automatic mode (mode 10) and
-

(refer to the SIMOLINK function block description @SL).

Synchronized data send, 1 cycle deadline

For the mode 3, 5 and 10, the telegram data of the previous bus cycle are processed in parallel to the bus cycle and equidistant SIMOLINK telegrams are sent and received. This allows the shortest SIMOLINK cycles to be configured. Ideally, this technique is suitable for applications with “**virtual shaft with values which uniformly change**”, which are required, for example, for printing machines.

The operating modes **automatic mode** (Mode 3) with processing in an interrupt task Ix should be used for jitter-free synchronization of the drives

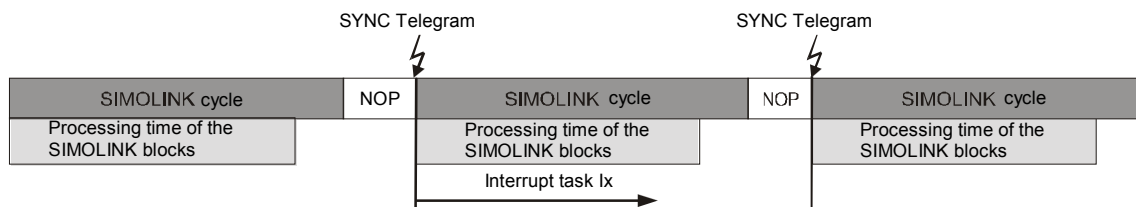

Fig. 4-16 Automatic mode (Mode 3)

and **external-cyclic mode** (Mode 5) with synchronization to the basic sampling time T0.

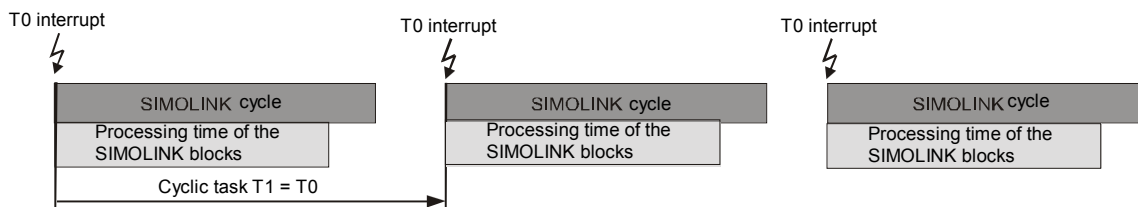

Fig. 4-17 External-cyclic mode (Mode 5)

The sampling time should be selected somewhat higher than the bus cycle time.

The external-cyclic mode offers the advantage that the processor hardware of two SIMOLINK rings can be synchronized to the (common) base sampling time T_0 .

In the external cyclic mode (Mode 5) it might happen in the case of a SIMOLINK transfer that, depending on the processing time and order of the SIMOLINK blocks, actual value and setpoint values are transferred in different scan cycles. This happens when the calculation of the blocks in scan time T_1 takes longer than the SIMOLINK data transfer.

Remedy:

Place all send and receive blocks of the SIMOLINK connection at the end of Task 1 (T_1)

or

Use the **SLDIS** dispatcher block to configure more (imaginary) slaves than in the SIMOLINK ring.

This moves back the time at which the sync message is generated. All messages are read and you achieve consistent processing.

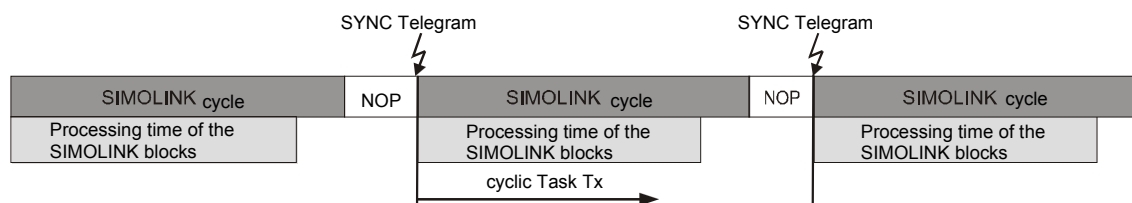

Fig. 4-18 Cyclic automatik-mode (Mode 10)

The cyclic-automatic-mode 10 offers the advantage to place the function block configuration in cyclic tasks, in opposed to mode 3.

Fastest sensing, synchronous

The jitter-free SL-master mode, external-mode is best suited for synchronous actual value sensing with the fastest processing (minimum deadline). This means, that it can be used as “**virtual shaft with dynamically changing values**”, for example, for packaging machines.

In the **external mode** (Mode 4) the SIMOLINK cycle is synchronized to the base sampling time T_0 . The SIMOLINK blocks are immediately executed in the configured interrupt task I_x when the SYNC telegram is subsequently received.

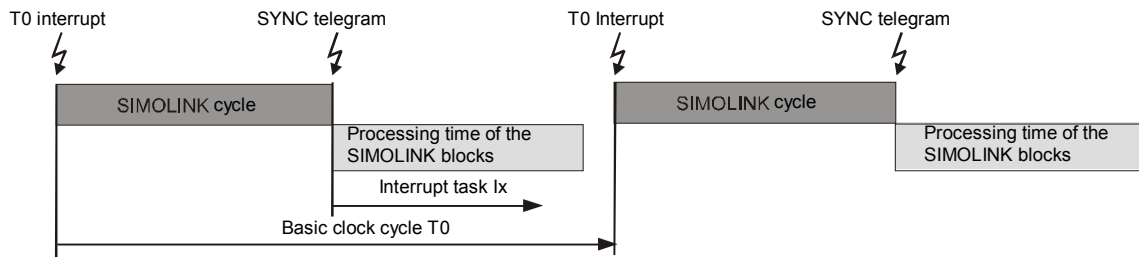

Fig. 4-19 External-mode (Mode 4)

The base sampling time T0 setting must correspond as a minimum to the bus cycle time plus the interrupt task processing time.

Fastest data send, non-synchronous

If data are to be transferred to other nodes after the calculation with minimum deadtime, then either the non-synchronous mode or the timer mode is used.

For the **non-synchronous mode** (Mode 1), data is directly output after the SIMOLINK blocks have been processed in a cyclic task Tx.

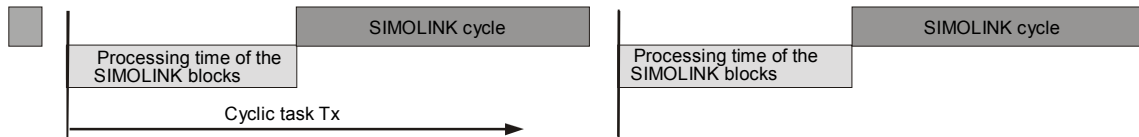

Fig. 4-20 Non-synchronous-mode (Mode 1)

In the **timer mode** (Mode 2), data is directly output after calculation in an interrupt task Ix which assigns the processing of the SIMOLINK blocks a higher priority.

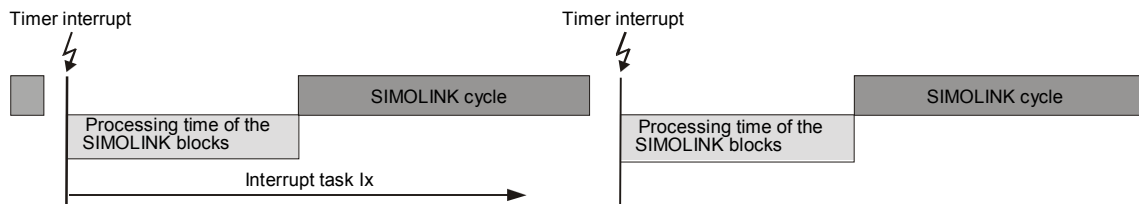

Fig. 4-21 Timer-mode (Mode 2)

In these non-synchronous SL-master modes, which exhibit jitter, the coupled drives cannot be operated with position synchronism if the SYNC telegram is sent in the time intervals which depend on the actual configuring. This allows the fastest possible data transfer between SL master (Mode 1 or 2) and the slave (Mode 0).

Reading telegrams, synchronous

The **slave mode** (Mode 0) is used to read and evaluate the bus data transfer in a drive ring, for e.g. monitoring and diagnostic purposes.

With each received SYNC telegram, the SIMOLINK module initiates that the configured interrupt task Ix is processed. If it is used as the receive section for fast data transfer between SL master and slave, all of the telegrams can be read and processed. Furthermore, it is possible to write a max. 8 telegrams, in order to, for example, transfer signals to the SL master.

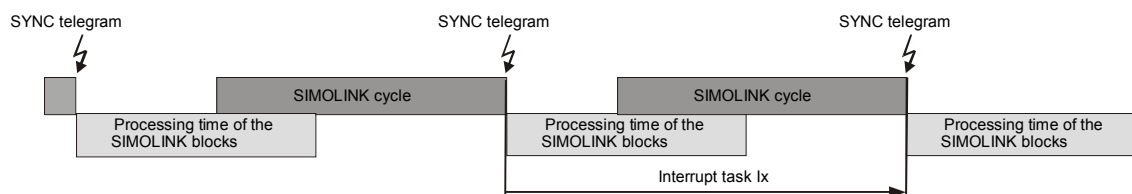

Fig. 4-22 Slave mode (Mode 0)

Coupling two automation systems

In order to send data between two automation systems via SIMOLINK, which exceeds the amount of data using 8 telegrams, two independent SIMOLINK rings are required. This means that every node can be configured once as SL master to send in one ring and as slave to receive in the other ring. This technique is used, for example, to achieve

- synchronized processing and
- extremely fast data transfer

between two SIMATIC FM 458-1 DP modules each with two EXM 448-1 or one EXM 448-2 expansion modules.

Cyclic or interrupt task ?

When selecting the operating mode, it should be noted, that interrupt task processing can interrupt cyclic tasks at any time. This can influence the timing. For the non-synchronous mode, the SIMOLINK cycle is delayed and for the external cyclic mode, T0 must be adapted to prevent computation time overflow or multiple sending of the same values which have not been re-calculated.

Synchronization to the base sampling time T0 can be set in 100 μ s intervals while interrupt tasks are initiated by the SYNC telegram, dependent on the telegram duration.

4.6.4 Configuring - first steps

The necessary settings are described that must be made or must be observed when configuring the system. These will be described using an example of a master-slave coupling (an EXM448-1 module is used as master). An EXM448-2 module has two integrated SIMOLINK interfaces that can be operated independently of one another. The SIMOLINK communications is configured analog to EXM448-1 and is not separately described.

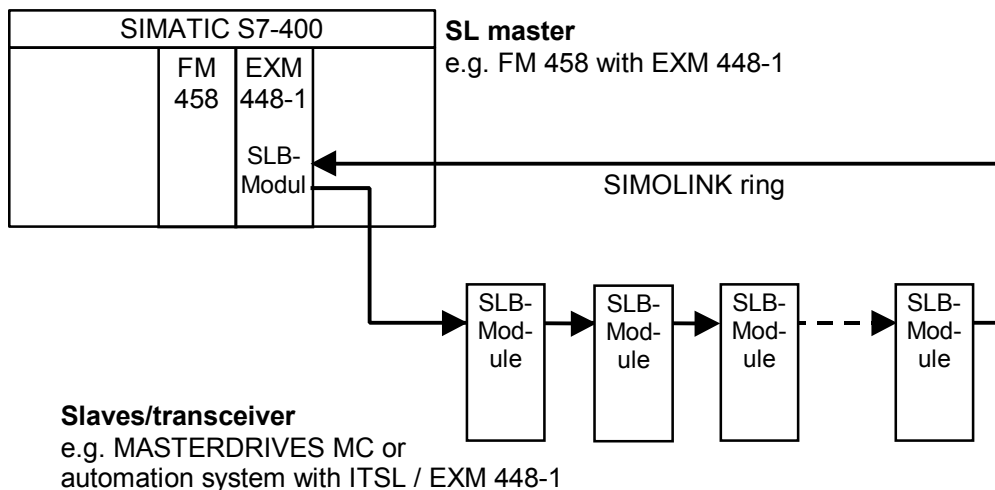

Fig. 4-23 Example for a master-slave coupling

Hardware

The SIMOLINK ring comprises the minimum of two and a maximum of 201 SLB modules, which are coupled to one another through fiber-optic cables. There is only one SL master on a ring. All of the other nodes are slaves.

An SLB module is a hardware component of an ITSL, an EXM 448-1 module or an option module SLB (**S**IMOLINK **B**oard, Order No. 6SX7010-0FJ00). Two SLB interfaces (ports) are integrated on an EXM448-2 module.

NOTE

Additional information on these modules and their installation is provided in the User Manual D7-SYS "Hardware", or SIMOVERT MASTERDRIVES Instruction Manual SLB SIMOLINK board.

4.6.4.1 Configuring the SIMOLINK coupling under STEP 7

For SIMATIC FM 458-1 DP with EXM 448-1, the basic clock cycle T0, possibly the interrupt task Ix and the symbolic hardware assignment for the SIMOLINK are set in the HW Config of STEP7 in the properties dialog box.

NOTE

The EXM 448-1 expansion module should be configured as EXM 448 in HWConfig.

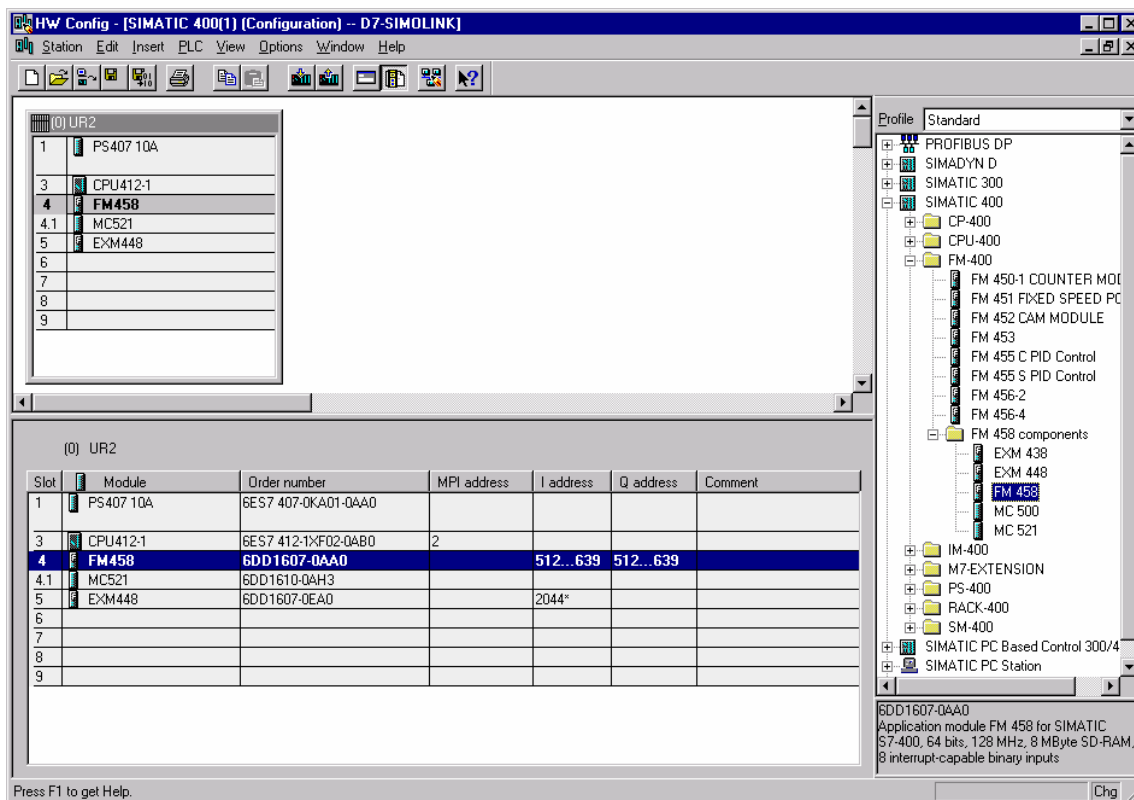

Fig. 4-24 Configuring for FM 458-1 DP with EXM448-1

Basic clock cycle

The basic clock cycle time must be set in HWConfig in the properties window under the "Basic clock cycle" tab.

The basic sampling time must match the PWM frequency set in the MASTERDRIVE MC (the factory setting is: 5 kHz, parameter P340). The time sectors are derived from this frequency.

The usual values are 3.2 ms, 1.6 ms and 0.8 ms, to which the system can be synchronized. 1.6 or 3.2 ms are set depending on the control type.

The value, set as the base sampling time, must also be entered in parameter P746 of the MASTERDRIVES MC.

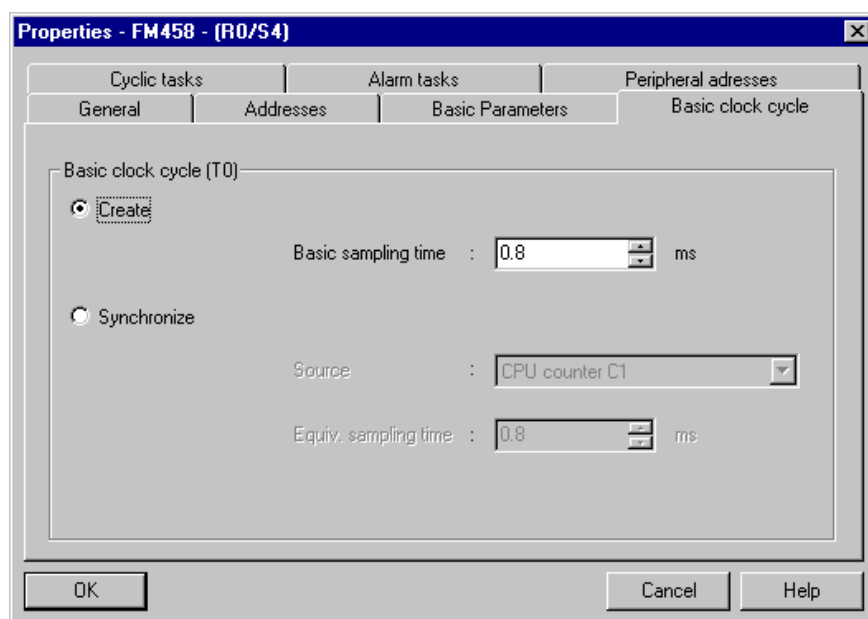

Fig. 4-25 Basic clock cycle in the HW Config

Interrupt task For modes 0, 2, 3 and 4, sources must be assigned to initiate the configured interrupt tasks.

The settings are made in HW Config in the Properties window under the "Interrupt task" tab, dependent on the configured hardware components.

Mode	Interrupt source to be set for interrupt task Ix of the SIMOLINK blocks, if:			
	EXM 448-1/EXM448-2, 1. Interface/ITSL, integr. interface 1. LE bus expansion	EXM 448-1/EXM448-2, 1. Interface/ITSL, integr. interface 2. LE bus expansion	EXM448-2, 2. Interface / ITSL, opt. interface 1. LE bus expansion	EXM448-2, 2. Interface / ITSL, opt. interface 2. LE bus expansion
0	LE bus interrupt 1	LE bus interrupt 3	LE bus interrupt 2	LE bus interrupt 4
2	LE bus interrupt 5	LE bus interrupt 6	LE bus interrupt 7	LE bus interrupt 8
3	LE bus interrupt 1	LE bus interrupt 3	LE bus interrupt 2	LE bus interrupt 4
4	LE bus interrupt 1	LE bus interrupt 3	LE bus interrupt 2	LE bus interrupt 4

Table 4-9 Interrupt task source assignment for expansion modules with SIMOLINK

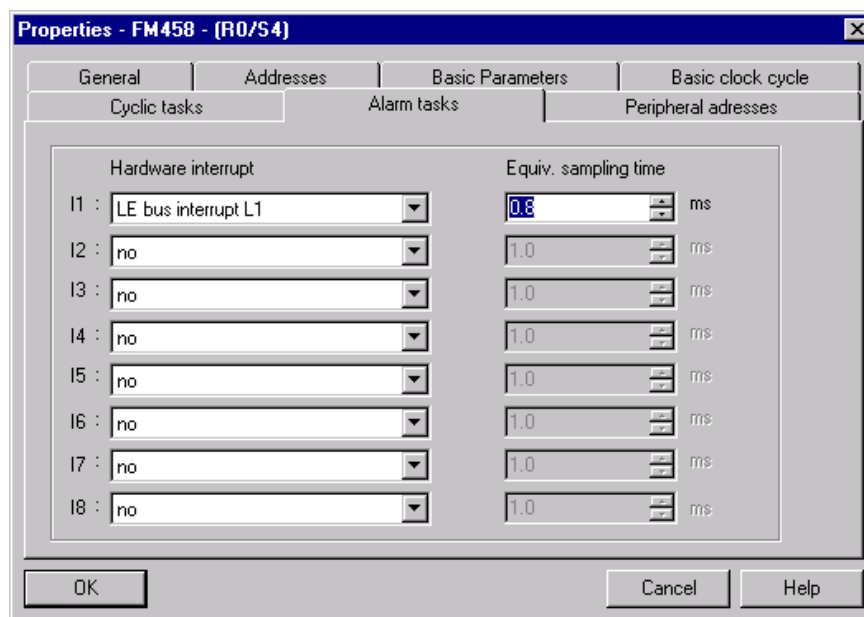

Fig. 4-26 Alarm task setting in the HW Config

Hardware addresses, SIMOLINK blocks

The SIMOLINK blocks @SL, SLAV, SLD, SLDIS, SLSV, SLSV2 and SLSVAV must be assigned to a HW address in the HW Config properties window of the EXM 448 under the "Plug-in module / I/O addresses tab.

The "process I/O" should be activated as plug-in module type. After this, symbolic names can be assigned for the I/O addresses (pre-set symbolic names are entered via the "Default" button).

The SIMOLINK blocks only use the symbolic name under "I/O address 2" (SIMOLINK does not require "I/O address 1").

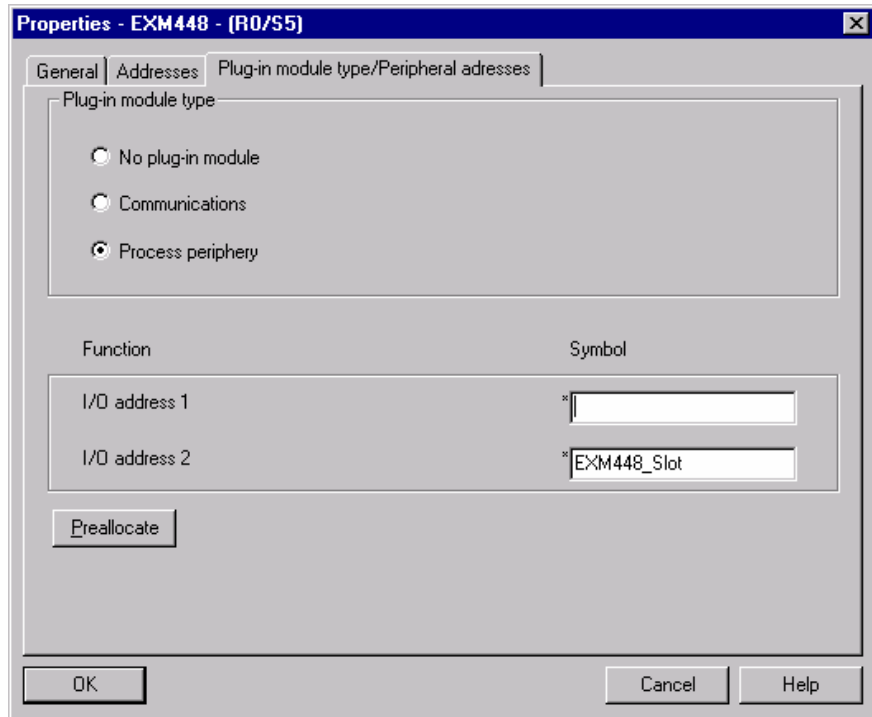

Fig. 4-27 Symbolic hardware assignment of an EXM 448-1

Different symbolic names are assigned for each SIMOLINK interface.

For example, when configuring an ITSL module, symbolic names are entered for the integrated (TAD) and the optional SIMOLINK interface (OAD) under the "Addresses" tab:

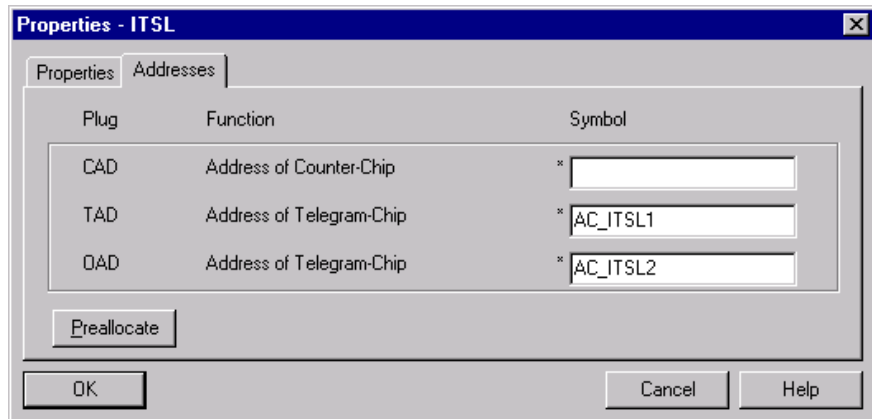

Fig. 4-28 Setting hardware addresses for an ITSL module with optional SLB module

4.6.4.2 SIMOLINK function blocks

The configuring engineer can use the following function blocks:

- @SL SIMOLINK central block
- SLAV SIMOLINK receive block, one for each actual value
- SLSV SIMOLINK send block, one for each setpoint
- SLSV2 SIMOLINK send block, for two setpoints
- SLSVAV SIMOLINK send and receive block for up to 8 setpoints and actual values of the slave
- SLD SIMOLINK delta evaluation
- SLDIS SIMOLINK dispatcher

The central block @SL permits the initialization and monitoring of communications in a SIMOLINK ring.

It may only be configured once for each SIMOLINK ring in a sampled cyclic task (T4 or T5) which is, as a minimum, 4x longer than the send and receive block.

If a transceiver no longer receives a telegram as a result of an interruption, then it automatically sends a special telegram, which evaluates the @SL function block. The address of the node is output at NDM, which first signals the fault.

NOTE

Additional information regarding the mode of operation and the connections (I/O) of the specified blocks are provided in the online help of the CFC Editor and in the "Function block library" reference Manual".

4.6.4.3 Parameterizing the MASTERDRIVES MC

The following parameters must be set in the SIMOVERT MASTERDRIVES MC (refer to the User Documentation „MASTERDRIVES MC“):

Parameter	Significance/setting
P740	Own node address, transceiver/slaves: 1...200 (dispatcher=0)
P741	Telegram failure time, if the telegram fails, fault F056 is output. The usual values: > 3 x bus cycle time (refer to P746)
P742	Send power, dependent on the length of the fiber-optic cable
P743	Number of nodes in the SIMOLINK ring
P745	Number of channels (this is only relevant for the dispatcher)
P746	Bus cycle time (only relevant for the dispatcher)
P749	Read address, which is generated from the node address and the channel number, whereby the node address does not have to match its own node address (P740) Example: 2.0 = node address 2, channel number 0
P751	Send data, Index 1 = channel 1 (low word), Index 2 = channel 1 (high word), Index 3 = channel 2 (low word), etc.
P755	SIMOLINK configuration 0x100 should be entered for modes 4 and 5 so that synchronization is realized (this is valid from firmware release 1.4 for MASTERDRIVES MC)

Table 4-10 Parameters for MASTERDRIVES MC

SIMOLINK						
P.-Nr.	Name		Ind	Indextext	Parameterwert	Dim
P740	SLB Teiln.Ädr.		001	1.SLB	1	
P741	SLB Tlg.Ausz.				10	ms
P742	SLB Sendeleist.				3	
P743	SLB AnzahlTeiln.		001	1.SLB	5	
P744	Q.SYNC.Auswahl		001		B0 Festbinekter 0	
P745	SLB Kanalanzahl		001	1.SLB	4	
P746	SLB Zykluszeit		001	1.SLB	3.20	ms
P747	Q.SLB Appl.Flags		001		B0 Festbinekter 0	
r748	SLB Diagnose		001	Anz. SYNC-Tlg	0	
P749	SLB Leseadresse		001		1.0	
			002		1.1	
			003		1.2	
			004		1.3	
			005		1.4	
			006		1.5	
			007		1.6	
			008		1.7	
r750	SLB Empf.daten		001		0x0	
P751	Q.SLB Sendedaten		001		K32 Zustandswort 1	
r752	SLB Sendedaten		001		0x0	
P753	Q.SyncZeitähler				K0 Festkon. 0%	
P754	Max.sync.Zeitsch				0 Buszykluszeit	
P755	SIMOLINK Konfig				0x100	

Fig. 4-29 Parameters for MASTERDRIVES MC (DRIVE Monitor and SIMOVIS)

- Number of nodes** When configuring the system, it should be noted that the number of nodes is restricted by the following factors:
- Pulse frequency set in MASTERDRIVES MC
The sampling time for the time sector to be synchronized is obtained from this pulse frequency (parameter number P340).
 - Data quantity to be transferred
The number of telegrams which are to be sent along the SIMOLINK ring between the SL master and the slaves.

The following formula applies:

$$N = \left(\frac{P746 + 3.18181 \mu\text{s}}{6.36 \mu\text{s}} - 2 \right) * \frac{1}{P745}$$

- with P746=bus cycle time (this depends on the pulse frequency and the time sector to be synchronized)
- with P745=number of channels
- with 6.36 μs =telegram run time

- Node tables** When the MASTERDRIVES MC pulse frequency is set to 5 kHz, for example, the following values are determined:

No. of channels	No. of nodes		
	0.8 ms (T2)	1.6 ms (T3)	3.2 ms (T4)
1	124	201	201
2	62	124	201
3	41	83	167
4	31	62	125
5	24	49	100
6	20	41	83
7	17	35	71
8	15	31	62

Table 4-11 Node table for various bus cycle times (drive converter/inverter time sectors in brackets)

4.6.5 Coupling diagnostics

LEDs

The user can use the 3 LEDs on the front of the SLB module to analyze the operating status.

Operating display

LED	Status	Diagnostics information
green	flashing	Error-free net data transfer via SIMOLINK
red	flashing	SLB module in operation
yellow	flashing	Data transfer with the information processor FM 458-1 DP or PMx is OK

Table 4-12 Operating display, SLB module

Fault display

LED	Status	Diagnostics information
green	dark/ bright	No net data transfer via SIMOLINK: Bus cable not connected or defective, poor fiber-optic cable transition, send power (launch power) too low
red	dark/ bright	SLB module power supply failed Replace the SLB module or power supply through FM 458-1 DP and check PMx
yellow	dark/ bright	No data transfer with the automation processor FM 458-1 DP or PMx, bus cable not connected or defective, poor fiber-optic cable transition, send power (launch power) too low, replace SLB module or automation processor FM 458-1 DP and PMx

Table 4-13 Fault display, SLB module

Fault output

The fault statuses are output coded at the outputs YF of the appropriate SIMOLINK blocks.

NOTE

Only the last fault event is displayed.

Value	Diagnostics information
	F: Fault cause R: System response A: Remedy
2	F: TAD input is incorrectly connected (e.g. HW address of CS8+SLB module) R: No telegram data transfer A: Use symbolic hardware assignment of the EXM 448-1/ EXM448-2 or ITSL module
3	F: Incorrect module or SLB module not inserted or defective hardware R: No telegram data transfer A: Use or replace SLB module
4	F: SLB module is already being used by another central block @SL, configured twice R: No telegram data transfer A: Only use one FB @SL for each SIMOLINK ring

Value	Diagnostics information F: Fault cause R: System response A: Remedy
5	F: Memory access problem (internal error message) R: No telegram data transfer A: Reduce the size of the application software or move to another process module
6	F: Send/receive block(s) signal: Central block @SL not configured R: No telegram data transfer A: Insert @SL in the software (min. 4 x sampling time of send/receive blocks)
9	F: This software does not support this hardware combination, e.g. CS8+SLB module R: No telegram data transfer A: Use an EXM 448-1 / EXM448-2 or ITSL module for the drive coupling
10	F: Modes 0, 2 and 4: Block was not configured in an interrupt task R: No telegram data transfer A: Configure the appropriate block in the interrupt task
11	F: Modes 1 and 3: Block was not configured in a cyclic task R: No telegram data transfer A: Configure the appropriate block in a cycle task
12	F: Mode 5: Block was not configured in a cyclic task with T1=T0 R: No telegram data transfer A: In HW Config: Select T1=T0, configure the appropriate block in cyclic task T1
13	F: Mode 4: Equivalent sampling time is not equal to T0 R: No telegram data transfer A: In HW Config: Select an equivalent sampling time = T0
14	F: Modes 0, 2 and 4: Interrupt source for the interrupt task is incorrect R: No telegram data transfer A: In HW Config: Set the interrupt task source as in the assignment table
15	F: Mode 1: Not all send/receive blocks in one sampling time R: No telegram data transfer A: Configure all of the send/receive blocks in the same sampling time
16	F: Incorrect mode setting R: No telegram data transfer A: Set a valid mode (mode 0...5) at FB @SL
17	F: Mode 0, FB @SL: incorrect node address (slave) at input ASL R: No telegram data transfer A: Select a valid setting at input ASL: 1...200
18	F: FB @SL signals: No send and receive blocks available R: No telegram data transfer A: Configure send and/or receive block(s)
19	F: No. of SIMOLINK telegrams too high or SIMOLINK cycle time exceeded R: Telegram data transfer up to max. possible number A: Configure max. 1021 net telegrams or increase SIMOLINK cycle time or configure fewer SIMOLINK blocks (refer to the formula)
20	F: Send/receive block signals: Incorrect slave address R: Restricted telegram data transfer functions A: Select valid slave address: 0...200
21	F: Send/receive block signals: Channel number incorrect R: Restricted telegram data transfer functions A: Select a valid channel number: 0...7

Value	Diagnostics information
	F: Fault cause R: System response A: Remedy
22	F: Mode 0: Slave attempts to write into an incorrect address R: Restricted telegram data transfer functions A: Select own slave address
23	F: Logical configuring error: Slave-to-slave communications was configured as duplex operation, however, only one direction is possible for each slave (send or receive) R: Send and receive the same data A: Either configure send or receive for slave-to-slave communications
30	F: Physical data transfer faulted on the SIMOLINK ring R: No telegram data transfer A: Increase send power (launch power) at one of the subsections, replace medium or connector
31	F: CRC error (check sum error), data transfer along the ring faulted R: Telegram failure A: Increase send power (launch power) at one of the subsections, replace medium or connector
32	F: Timeout error in the SIMOLINK ring, bus node signals a fault R: No telegram data transfer A: FB @SL, evaluates output NDM, beforehand, check node and medium
33	F: Mode 0: Signaled SIMOLINK cycle time (in the special telegram from SL master) does not correspond to the configured equivalent sampling time R: Restricted telegram data transfer functions A: In the HW Config: Adapt the equivalent sampling time of the slave to that of the SL master

Table 4-14 Error output, SIMOLINK-FBs

4.6.6 Synchronizing individual SIMOLINK rings

When using the FM458-1 DP and the EXM448-2 module, there are additional ways of synchronizing up to three SIMOLINK masters on a slave ring that in this case act as clock master. This operating mode is set-up as follows: For the FM458-1 DP module, the LE bus interrupt of the leading slave ring (for EXM448-2 is only permitted as the first interface as master clock) is set as source for the T0 clock cycle - and for the master interfaces to be synchronized, operating mode 4 or 5 is selected. In this case, the systems are synchronized almost jitter-free.

When using 2 EXM448-2 connected to an LE bus, only one of the two X1 interfaces of the EXM448-2 can be used as clock master.

NOTE

The clock cycle of the "clock master" can fail in operation (e.g. if the leading ring is isolated). This is the reason that measures must be configured so that when the clock cycle returns, new synchronization to function block DTS can be initiated.

4.6.7 Options and accessories

The following are available to configure a SIMOLINK coupling and as spare part:

Order No.	Components
6SE7090-0XX84-0FJ0	SLB module, spare part (without documentation, without connector)
6SX7010-0FJ00	SLB module, retrofit package (documentation, 2 fiber-optic cable connectors, 5m plastic opto-cable, 1 connector for terminal X470)
6SY7000-0AD15	Attachment for SLB (2 LWL cables, 5m plastic opto-cable)
6SX7010-0FJ50	System package for SLB (40 fiber-optic cable connectors, 100m plastic opto-cable, 20 connectors for terminal X470)

Table 4-15 SIMOLINK option modules and accessories

4.7 Table function

4.7.1 Introduction

The table function in SIMATIC TDC / SIMADYN D provides the user with the possibility of linking-in and using tabular values (values in a table) in a configured software application. In this case, the function blocks TAB and TAB_D must be configured on the SIMATIC TDC and SIMADYN D sides. Tabular values, data type REAL are managed using the TAB and data type DINT, using TAB_D. The user provides the tabular values.

The table function can be configured in three modes:

- **Manual mode**, i.e. the tabular values are directly entered at the block via an online interface (e.g. CFC in the test mode), or transferred to the block using teach-in from the program (refer to Fig. 1).
- **Automatic mode: Communications**, i.e. the tabular values are transferred via a communications interface (TCP/IP, DUST1, S7 via P bus). In order to transfer tabular values from an S7 control to a SIMATIC FM 458-1 DP application module via the P bus, in addition, the WR_TAB should be configured on the S7 control side (refer to Fig. 2).
- **Automatic mode: Memory card**, i.e. the table values are downloaded into the memory card, from where they are read.

NOTE

The "Automatic mode, memory card" mode is presently still not available. It should be noted, that it is only possible to toggle the modes between "**Manual mode**" and "**Automatic mode: Communications**" as well as "**Manual mode**" and "**Automatic mode: Memory card**".

A validity check is made if the tabular values have been entered or transferred. The address of the table is displayed at "TAB" output.

The tabular values are managed twice, i.e. in two tables. The table, defined as "valid" (=active) is used for all arithmetic/computation operations of the configured application software. The "invalid" (=inactive) table is used to manage value changes. All of the tabular values, changed by the user, are initially transferred into the invalid table. If the inactive table is activated, the new tabular values are mirrored in the second table. The table which had been active up until then automatically becomes invalid. This means that the new tabular values are available in both tables.

Both tables can be saved in the SAVE area which is backed-up (buffered) by a battery in order to prevent data loss (connection SAV=1 when initializing).

NOTE

A precise description of function blocks TAB and TAB_D is provided in their respective online help.
A detailed description of the WR_TAB function blocks is provided, further below in the Section "Function block WR_TAB".

4.7.1.1 Overview, "Manual mode"

The principle procedure in the "Manual mode" is shown in the following diagram:

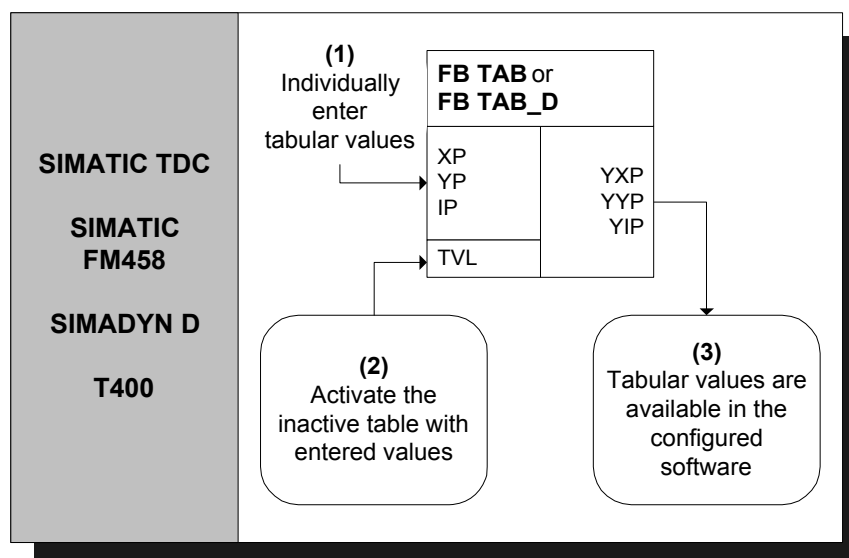

Fig. 4-30 Principle procedure in the "Manual mode"

A detailed description of the "Manual mode" is provided in Section "Manual mode" (Page 4-21)

4.7.1.2 Overview, "Automatic mode: Communications"

In the "Automatic mode: Communications", tabular values can be transferred using the following communication versions:

- S7 via the P bus for SIMATIC FM 458-1 DP (it is necessary to additionally configure the WR_TAB on the control side)
- TCP/IP (tabular values can be transferred from a SIMATIC TDC module to another one using the CTV and CRV FBs)
- DUST1 (tabular values can only be transferred via a DUST1 interface)

The tabular values are transferred using data telegrams.

The following diagram illustrates the principle procedure in the "Automatic mode: Communications" for transferring tables from an S7 control to a SIMATIC FM 458-1 DP application module via the P bus:

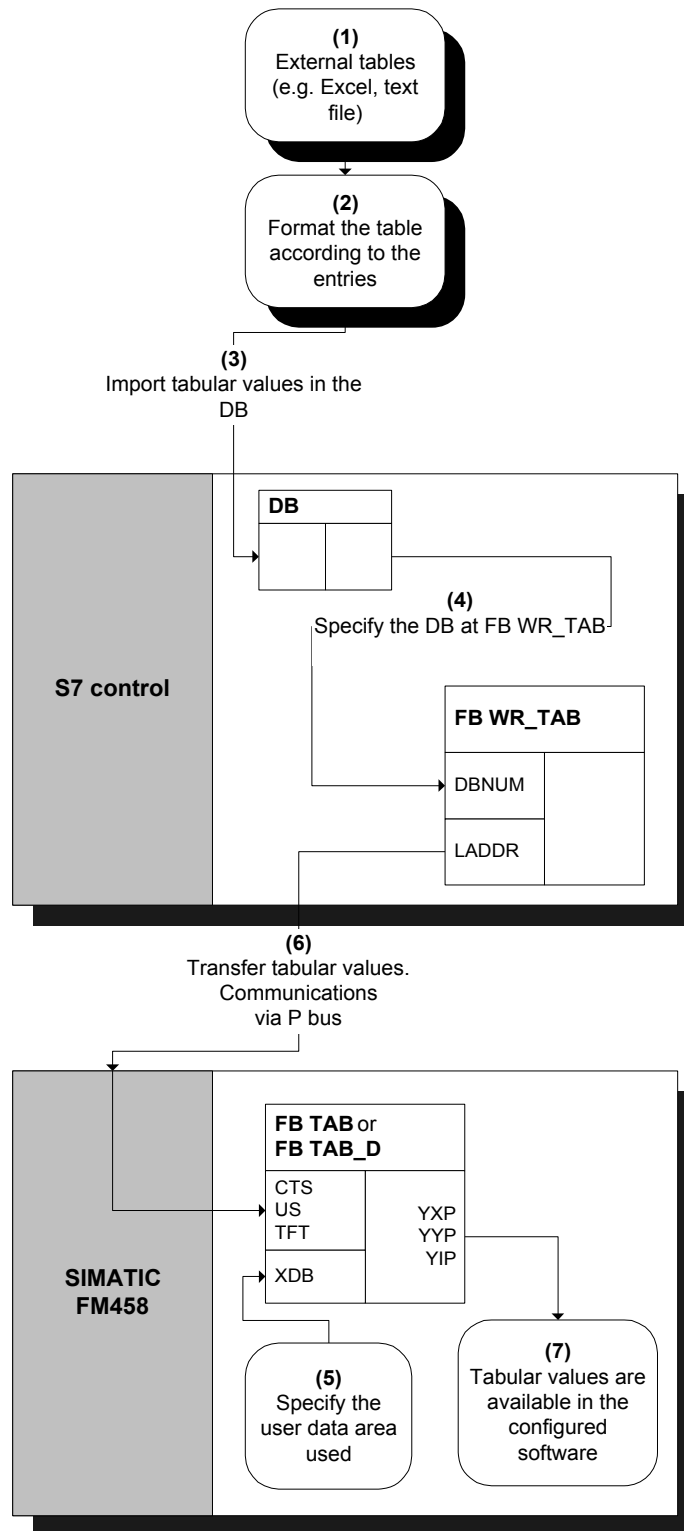

Fig. 4-31 Principle procedure for "Automatic mode: Communications"(via P bus)

A detailed description of the "Automatic mode: Communications" mode to transfer tables from an S7 control to a SIMATIC FM 458-1 DP application module is provided in the Section "Automatic mode: Communications" (Page 4-21).

4.7.1.3 Function block WR_TAB

The function block WR_TAB is used to transfer tables from one S7 control to a SIMATIC FM 458-1 DP application module. The tabular values (permissible data types are REAL and double integer) are saved in a data block. They are transferred from WR_TAB to the function blocks TAB and TAB_D on the SIMATIC FM 458-1 DP application module, which then internally manages the tabular values.

The WR_TAB should be configured on the control side. The tabular values are transferred from one S7-400 control to a SIMATIC FM 458-1 DP application module via the P bus. All of the values are always transferred, which are in the DB specified at the DBNUM input.

Symbol

WR_TAB	
Block activation	BO EN TABTEL W — Number of data blocks to transfer the complete DB contents
Request to write a new table	BO REQTAB CNTTEL W — Number of data blocks already transferred
Request to write the tabular values in the data block	BO REQDB STATUS W — Actual processing status
Last data block for the table	BO LASTDB ERROR W — If required fault messages
Logical module address	W LADDR DONE B — Status parameter DONE: Send operation completed
Data set number for the read and write data set	BY RECNUM
Data block number	W DBNUM
TIMEOUT time for receiving the acknowledge telegram from the FM module	DW TFT

I/O

The individual connections (I/O), their data types and a connection description are listed in the following table:

Parameter	Declaration	Data type	Description
REQTAB	INPUT	BOOL	REQTAB = 1: Request to write a new table As long as FB WR_TAB transfers data, it is not permissible that the REQTAB input is reset.
REQDB	INPUT	BOOL	REQDB = 1: Request to write the tabular values which are saved in the data block
LASTDB	INPUT	BOOL	Last DB for the table
LADDR	INPUT	WORD	Logical address of the SIMATIC FM 458-1 DP application module
RECNUM	INPUT	BYTE	Data set number for the read and write data set FB WR_TAB does not support data set numbers 0 and 1.
DBNUM	INPUT	WORD	Data block number of the DB in which the tabular values are located. As long as FB WR_TAB transfers data, the data block number may not be modified.
TFT	INPUT	DWORD	TIMEOUT time in ms for receiving acknowledge telegrams from the SIMATIC FM 458-1 DP application module.
TABEL	OUTPUT	WORD	Number of data blocks required to transfer the complete DB contents The output is only reset when the next task/job is activated.
CNTTEL	OUTPUT	WORD	Number of data blocks already transferred to the FM module The output is only reset when the next task/job is activated.
STATUS	OUTPUT	WORD	Indicates the current status of the processing / data transfer: 0: Table transfer is inactive 1: Table transfer is active. Table values have been partially transferred from a DB (wait for the next partial transfer) 2: Table values have still not been completely transferred from a data block. The output is only reset when the next task/job is activated.
ERROR	OUTPUT	WORD	If a fault/error occurs while processing the function, then the return value is an error code Otherwise, SFC58 and SFC59 errors will be displayed. If an error occurs during communications with the FB TAB, the error messages of FB TAB or FB TAB_D are directly displayed. The output is only reset when the next task/job is activated.
DONE	OUTPUT	BOOL	Status parameter DONE=1: Send operation has been completed The DONE=1 connection is only reset if the next transfer of table values is initiated.

The following errors can occur and are displayed at the ERROR output:

Error code	Explanation	Remedy
0xB210	OK	-
0xB211	Logical module address invalid	Specify a valid module address at input LADDR.
0xB212	Data set number not valid	Check the data set number for P bus communications.
0xB213	Invalid table data format	Tabular values must have data type REAL for the TAB and data type DINT for the TAB_D.
0xB214	The data format of the new data set does not match that of the previously transferred data set	Ensure that all of the tabular values have the same data format.
0xB215	FM 458-1 DP does not respond	Check the communications connection and configuring.
0xB216	Table is too large	Transfer the table in sub-sets, i.e. either distribute tabular values over several DBs or after each partial transfer write new (additional) tabular values into DB and transfer.
0xB217	Table is not complete (X / Y values)	Complete the table, there must be a Y value for each X value.
0xB218	REQTAB is reset during processing	Transfer the tabular values again.
0xB219	REQDB reset during processing	Transfer the tabular values again.
0xB21A	DB number is not valid	Specify a valid DB number.
0xB21B	TIMEOUT when receiving the acknowledge telegram	Check the communications coupling and configuring. Transfer the tabular values again
0xB21C	Invalid processing status	Check the configuring of the WR_TAB.

Errors associated with the SFC58 or SFC59 are displayed at the ERROR output.

If an error occurred during communications with the FB TAB, then the error messages of FB TAB and FB TAB_D are directly displayed at the ERROR output.

4.7.2 Manual mode

4.7.2.1 Application

The "Manual mode" mode represents the simplest way of inserting tabular values into a configured software package. However, it is comparatively time consuming as data has to be manually entered or taught-in from the program.

Entering tabular values

After the TAB or TAB_D has been correctly configured, the tabular values can be entered one after another. To start off with, the table size, i.e. the number of value pairs (=points) should be specified at input NP. If the table is to be saved in the SAVE area, then input SAV of the must be 1.

The tabular values can then be subsequently entered. In this case, to start, the index point *i* should be specified at input IP of the value pair to be entered. The X and Y value of the point should then be entered at inputs XP and YP. In order to accept the entered value, after entering each value pair, input WR should be set from 0 to 1. Before entering the next point, the index at input IP should be incremented. The values for this point should then be entered. This procedure is repeated until all of the values have been entered.

A specific sequence does not have to be observed when entering the individual points.

The number of entered points must match the data at input NP.

All of the entries during this procedure are transferred into the inactive table of the and are only available after being activated in the configured software. In order to activate the inactive table with the entered values, input TVL should be set to 1.

After the TVL input has been set to 1, the inactive table was activated and all table values are copied into the new, inactive table so that both tables have the same contents. This can take some time depending on the size of the table.

Additional changes can then be again made in the inactive table and are only available after this has been re-activated again.

Interrogating the tabular values

In order to output the entered tabular values, after entering the data at input IP, the index of the point *i*, to be displayed is specified, and input RD is set from 0 to 1. The tabular values of point *i* are then displayed at the outputs YXP (X value) and YYP (Y value). The index of point *i* is output at output YIP.

4.7.2.2 Configuring

For the "Manual mode", only the TAB and/or TAB_D have to be configured depending on whether tabular values, data type REAL and/or DINT have to be managed. Each table may only contain values associated with one data type. If several tables having different data types are to be managed, then an TAB or TAB_D must be configured for each table.

The function blocks TAB and TAB_D should be configured in the same sampling time of 32ms. The following connection (I/O) settings are required:

AUT = 0 (automatic mode de-activated)
NP = [specifies the table size]
XP = [enters the X values]
YP = [enters the Y values]
IP = [enters the value pair to be changed]
TVL = 1 (to activate the table after all of the values have been entered)
WR = 1 (to transfer the value pair which was entered in the table)
RD = 1 (to display the value pair, specified under IP, at outputs YXP and YYP)

NOTE

If, in the "Manual mode" the CTS connection is set to "0" when initializing (CTS=0; AUT=0), then it is no longer possible to changeover into the "Automatic mode: Memory card" (CTS=0; AUT=1).

If the CTS connection is set to "0" while initializing, and the "Automatic mode: Memory card" is activated (AUT=1), then it is possible to subsequently changeover to "Manual mode" (CTS=0; AUT=0). The table, saved on the memory card, can then be processed in the "Manual mode".

If, after this, a change is made back to "Automatic mode: Memory card" (CTS=0; AUT=1), this no longer has any effect, because it is only activated during the initialization operation.

If a communications interface is configured at the CTS connection, it is possible to toggle, as required between "Manual mode" and "Automatic mode: Communications".

4.7.3 Automatic mode: Communications

4.7.3.1 Application with an S7 control and SIMATIC FM 458-1 DP application module

Transferring tabular values

The following prerequisites must be fulfilled in order to successfully transfer tables: :

- The function blocks TAB and/or TAB_D must be configured in the FM 458-1 DP application module corresponding to the configuring specifications for "Automatic mode: Communications" (A detailed explanation is provided in Section "Configuring for S7 control and SIMATIC FM 458-1 DP application module").
- The X and Y values of a table in a DB must always be present alternating. There must be a Y value for each X value, so that the number of values in a data set is always an integer number.

In order to start data transfer, inputs REQTAB and REQDB at WR_TAB must be set to 1. The tabular values of the DB, specified at input DBNUM at WR_TAB can then be transferred.

The actual number of transferred data blocks is always displayed at the CNTTEL output of the WR_TAB.

The number of data blocks is displayed at the TABTEL output of the WR_TAB, which is required until the complete contents of the DB are transferred to the SIMATIC FM 458-1 DP application module.

If the tabular values have been completely entered in the specified DB, or if it involves the last partial transfer of a table (sub-set of a table), which does not "fit" completely into a DB, then before starting the transfer, input LASTDB of the WR_TAB should be set to 1. This means that the SIMATIC FM 458-1 DP application module is signaled at the end of the data transfer. The STATUS output of the WR_TAB then changes from 2 to 0.

NOTE

All of the tabular values, which are located in the DB, specified at the DBNUM input of the WR_TAB, are always transferred.

Table too large for a DB

If the table is too large for a data block, then the tabular values are split-up into individual sub-sets for transfer. The procedure is as follows:

To start, the first table section is written into the DB and is then transferred as described above. The LASTDB input of the WR_TAB remains at 0. The STATUS output of WR_TAB stays at 2 during data transfer and then changes, at the end of the table sub-set transfer (partial transfer) from 2 to 1.

The old tabular values in the DB should then be overwritten with the following tabular values. Once this has been completed, at WR_TAB the REQDB input should be again set from 0 to 1 to activate the next table sub-set transfer.

This procedure should be repeated until all of the tabular values have been transferred.

At the last sub-set transfer, input LASTDB of the WR_TAB should be set from 0 to 1. This signals the SIMATIC FM application module that data transfer has been completed. The STATUS output of the WR_TAB then changes from 2 to 0.

NOTE

If there is adequate user memory available, the table can also be saved in several different DBs. In this particular case, for each table sub-set transfer, only the matching DB number at the input DBNUM of the WR_TAB has to be specified. However, it should be ensured that the DBs are transferred in the correct sequence, so that all of the tabular values are transferred in an increasing sequence.

Data transfer duration

The time taken to transfer the tabular values depends on the following factors: :

- Number of tabular values
- Size of the data blocks
- Sampling time of the TAB and TAB_D
- WR_TAB processing time

In each cycle, a telegram with 56 tabular values is transferred, from the control to the SIMATIC FM 458-1 DP application module.

The time taken for a table to be transferred can be calculated as follows:

$$\text{Duration of the data transfer} = \left[\frac{\text{No. of tabular values}}{56} \right] * \text{cycle time of the slowest FB (i.e. TAB, TAB_D or WR_TAB)}$$

The time taken for the data to be transferred via the P bus is not relevant for this estimation, as this data transfer time is generally less than 1ms and generally, the function blocks TAB and TAB_D are configured in sampling times which are greater than 32ms.

If a table is distributed over several data blocks, the time required increases. The reason for this is that in addition to the time taken to transfer the tabular values, which can be determined using the formula above, the user has to manually make the changes described above.

After a table has been transferred, the inactive table, in which transferred data are located, is activated and all table values are copied into the new, inactive table so that both tables have the same contents. This can take some time depending on the size of the table.

4.7.3.2 Configuring for S7 control and SIMATIC FM 458-1 DP application module

The following function blocks must be configured for the coupling between an S7 control and an SIMATIC FM 458-1 DP application module via P bus:

- SIMATIC FM 458-1 DP application module:
 - TAB (for REAL data type) and/or
 - TAB_D (data type DINT)
 - @CPB (P-bus coupling, central block)
- S7 control:
 - WR_TAB

Each table may only contain values associated with one particular data type. If several tables with different data types are to be managed, then an TAB or TAB_D must be configured for each table.

WR_TAB is used to transfer the tabular values from SIMATIC DB to function blocks TAB and TAB_D. The tabular values are transferred using a data telegram. When the last data telegram has been transferred, the TAB or TAB_D is automatically signaled that all of the tabular values have been transferred and that the table should be activated. WR_TAB receives a checkback signal as to whether activation was successful or not. After the table was successfully activated, its address is output at the TAB output of the TAB or TAB_D.

The usual restrictions regarding P bus communications apply for communications between WR_TAB and TAB / TAB_D:

WR_TAB input RECNUM: $2 \leq \text{RECNUM} \leq 127$

FB TAB, FB TAB_D: Mode, only refresh

FB TAB, FB TAB_D: Channel name (TAB) max. 6 characters

TAB and TAB_D TAB and TAB_D should be configured as follows:

They should be configured in a sampling time greater than or equal to 32ms. The following connection settings are required:

CTS = [name of the configured communications interface]
AUT = 1 (automatic mode activated)
US = [channel name.address stage1] (address data for receive)
MOD = [data transfer mode] (H=Handshake; R=Refresh; S=Select; M=Multiple)
TFT = [monitoring time in milliseconds] (maximum telegram failure time while receiving tabular values)
NP = [specifies the maximum table size]

NOTE If a communications interface is configured at the CTS connection, it is possible to toggle, as required between "Automatic mode: Communications" and "Manual mode".

WR_TAB The following connection settings should be configured at WR_TAB:

LADDR = [specifies the logical address of the SIMATIC FM 458-1 DP application module]
RECNUM = [specifies the data set number for the read and write channels. This must be identical with "Address stage1" at the US connection of the TAB or TAB_D.]
DBNUM = [specifies the data block number]

4.7.3.3 Inserting tabular values in the data block

In order to be able to transfer tabular values to a SIMATIC FM 458-1 DP application module, they must be available in a data block (DB). The DB should be programmed on the control side.

There are two ways of generating a DB with the required tabular values:

- Generating a new DB in STEP7 and manually entering the tabular values in the application "LAD/STL/CSF"
- Importing tabular values from an existing table (e.g. MS Excel) as external source in STEP7

4.7.3.3.1 Manually entering tabular values

In this case, it involves the simplest method of providing tabular values in a DB. It is realized by entering the initial (starting) and actual values of the individual table values manually in a newly generated DB in the application "LAD/STL/CSF". The steps required will now be explained.

NOTE

The initial value is any value which can be defined for every tabular value. It is only used if there is no actual value specified for the associated tabular value.
 The actual value is that value which is made available as tabular value in the configured software. The required tabular values should be specified here.

(1) Generating a new DB under STEP7

To start, a new DB should be generated under STEP7. In this case, the "Blocks" folder is selected in the appropriate S7 program and in the context-sensitive menu, the entry "Insert new object → data block" is selected.

The procedure is shown in the following diagram:

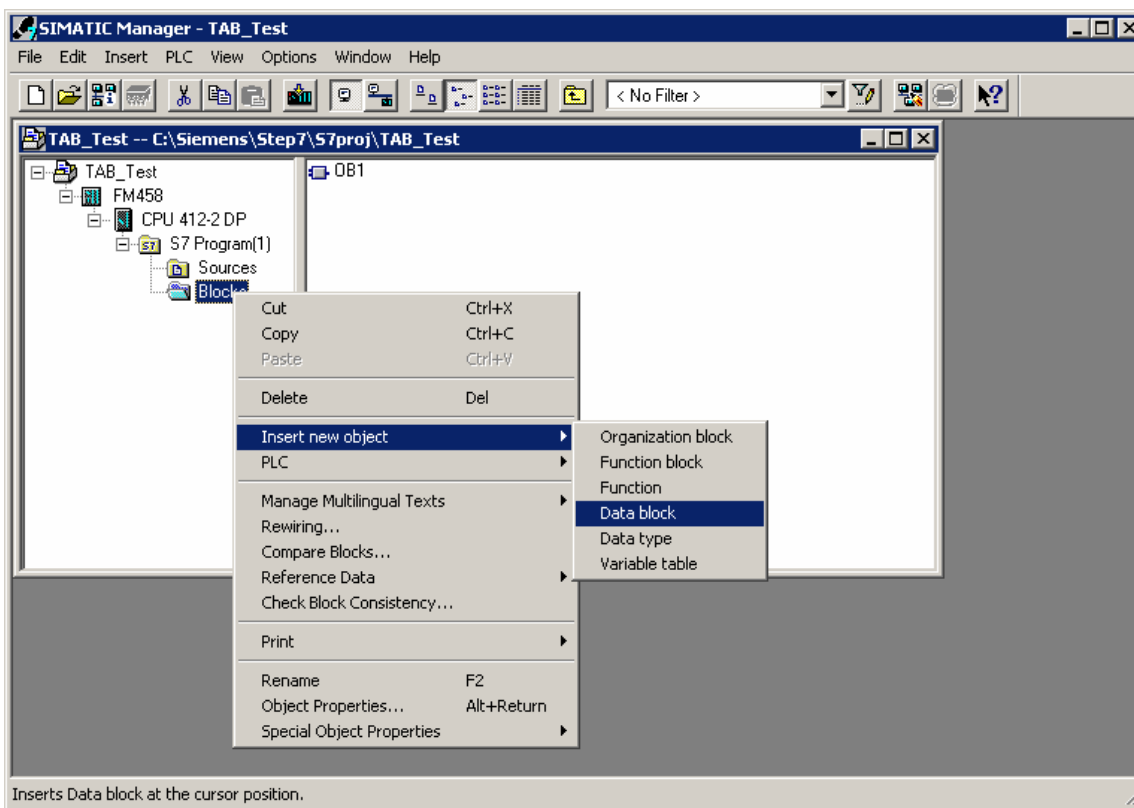

Fig. 4-32 Generating a new data block under STEP7

(2) Opening the new DB

The next step is to open the newly generated DB by double-clicking with the application "LAD/STL/CSF". "DB Editor" is the tool which is used to generate it and only one "Data block" is generated.

The following diagram illustrates the selection when opening a new DB:

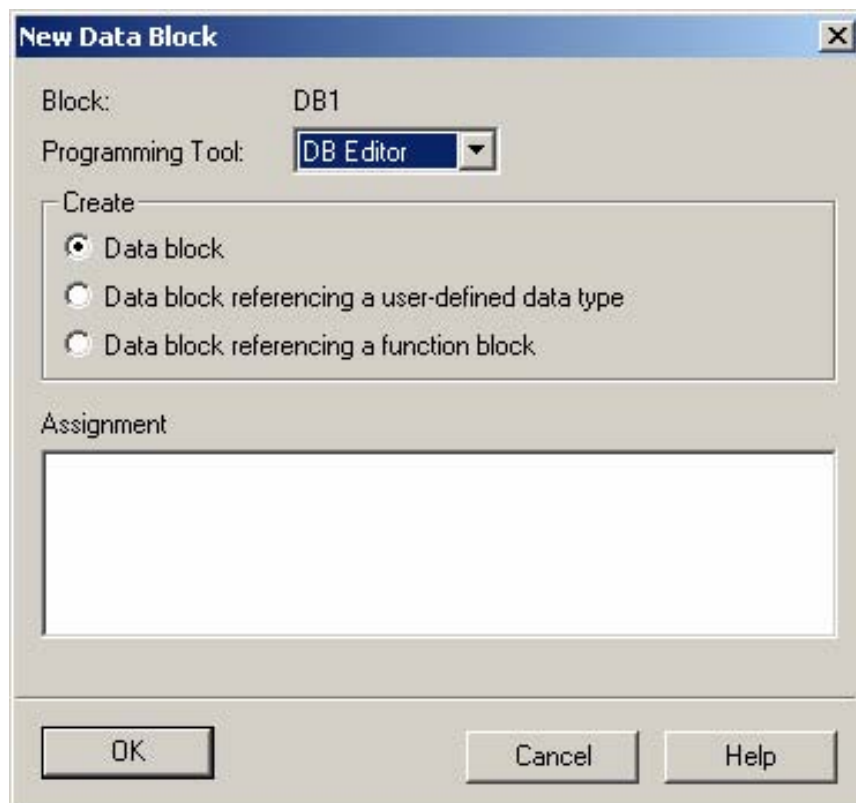

Fig. 4-33 Making a selection when generating a new DB

The opened, new DB is illustrated in the following diagram:

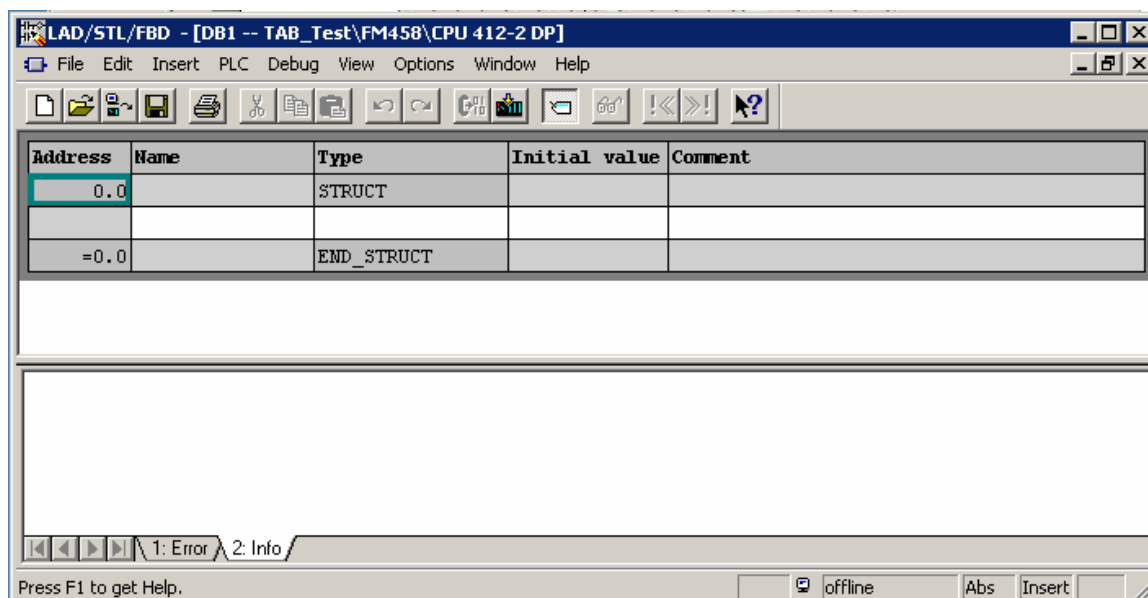

Fig. 4-34 Newly generated DB in the application "LAD/STL/CSF"

(3) Entering the tabular values

The required tabular values can now be entered. It should be ensured that the X and Y values are entered, alternating.

To start, the data type, used in the table, should be entered (REAL or DINT). In this case, the name is always "Data type", "WORD" type and initial value for data type REAL "W#16#1", for data type DINT "W#16#2".

Then, for each individual tabular value, the name, data type ("Type" column) and value ("Initial value" column) should be entered.

The procedure when entering tabular values, data type REAL, is shown in the following diagram:

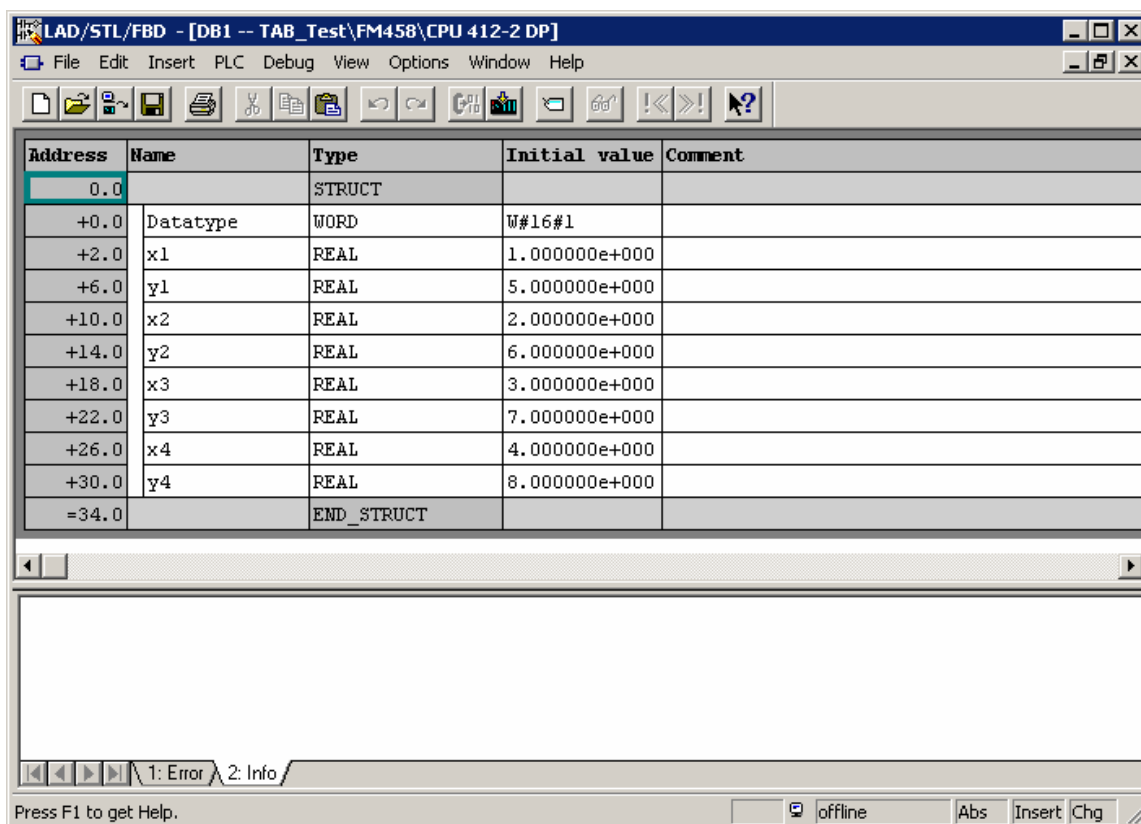

Fig. 4-35 Manually entered tabular values in the "LAD/STL/CSF" application

HINWEIS

Only values associated with the same data type may be included in a table. For this reason, specifying an ARRAY is an effective way of entering data. This means that the data type doesn't have to be specified each time.

Refer to the online help of the application "LAD/STL/CSF" - especially "Help for STL" for the procedure to make entries for an ARRAY type.

(4) Saving the DBs

After the tabular values have been completely entered, the DB can be saved under "File → Save".

The tabular values are then located in the DB for transfer.

4.7.3.3.2 Importing tabular values

The tabular values, provided in the DB, can also be imported from an external source, e.g. an MS Excel table. However, the following points should be observed for error-free import:

- The source file of the table must have a specific format
- The source file must be linked-in as external source file under STEP7
- A new DB is generated from the external source file
- The necessary points and steps, required for the import operation, will now be explained.

Table format

In order to import an existing table (e.g. generated using Excel) into the DB, it must be compliant with a specific format syntax:

- The table must contain a header, which contains information about the name of the DB and the version.
- Information about the structure and the data type of the tabular values should then be specified.
- The tabular values are then specified (as initial values).
- It should be observed that X and Y values must always be specified, alternating.
- The table should be saved with the *.AWL extension.
- The table can then be used as external source file.

HINWEIS

The *initial value* is any value which can be defined for each tabular value. It is only used if an actual value is not specified for the associated tabular value.

The tabular values are exclusively defined as *initial values*. *Actual values* are not used.

This significantly reduces the file size and in turn, the required memory.

An example of a table with four X and four Y values, data type REAL is shown in the following diagram:

```

Beispieltable_real.txt - Editor
Datei Bearbeiten Suchen ?

DATA_BLOCK DB 1
TITLE =
VERSION : 0.1

STRUCT
Datatype : Word := W#16#1 ;
  x1 : REAL := 1.000000e+000;
  y1 : REAL := 5.000000e+000;
  x2 : REAL := 2.000000e+000;
  y2 : REAL := 6.000000e+000;
  x3 : REAL := 3.000000e+000;
  y3 : REAL := 7.000000e+000;
  x4 : REAL := 4.000000e+000;
  y4 : REAL := 8.000000e+000;
END_STRUCT;
BEGIN
END_DATA_BLOCK
    
```

Fig. 4-36 An example of a table with values, data type REAL

An example of a table with two X and two Y values, data type DINT is shown in the following diagram:

```

Beispieltable_dint.txt - Editor
Datei Bearbeiten Suchen ?

DATA_BLOCK DB 1
TITLE =
VERSION : 0.1

STRUCT
Datatype := W#16#2 ;
  x1 : DINT := L#123456;
  y1 : DINT := L#789012;
  x2 : DINT := L#654321;
  y2 : DINT := L#210987;
END_STRUCT ;
BEGIN
END_DATA_BLOCK
    
```

Fig. 4-37 An example of a table with values, data type DINT

From Excel to STL

The following sections explain, using examples, how to re-format an Excel table to obtain the required table format.

The file example, shown in the following diagram, is formatted step-by-step corresponding to the specifications of the required table format.

	A	B	C
1	x-Wert	y-Wert	
2		1	5
3		2	6
4		3	7
5		4	8
6			
7			
8			
9			
10			
11			
12			
13			

Fig. 4-38 An example of a table in MS Excel

(1) Header

Initially, the required header is inserted. To do this, 5 lines are inserted at the beginning and the following data is entered:

- DATA_BLOCK DB 1 [number of the DB]
- TITLE = [enter as required]
- VERSION : 0.1 [version data]

The Excel table with inserted header is shown in the following diagram:

	A	B	C
1	DATA_BLOCK DB 1		
2	TITLE =		
3	VERSION : 0.1		
4			
5			
6	x-Wert	y-Wert	
7	1	5	
8	2	6	
9	3	7	
10	4	8	
11			
12			
13			

Fig. 4-39 An example of a table in MS Excel with inserted header

(2) Insert structure and tabular values

In a next step, the structure of the tabular values and the values, specifying the data type, are inserted. In this case, two lines plus an initial and end line are inserted for each value pair. Furthermore, a line is inserted at the start to specify the data type used.

The start of the structural data is displayed in the starting line with the "STRUCT" entry. The data type, used in the table, is specified in the following line ("W#16#1" for data type REAL, "W#16#2" for data type DINT).

This is followed by the structural data and tabular values for the individual value pairs, where X and Y values are always entered alternating. The tabular values are specified corresponding to the data type used (in this case REAL). The end of the structural data is displayed in the final line with the "END_STRUCT;" entry.

Finally, only the data for the data section of the actual values has still to be specified ("BEGIN" and "END_DATA_BLOCK"). As the tabular values already have the structural data in the starting (initial) values, it is not necessary to specify the individual actual values.

The Excel table with inserted structural data and tabular values is shown in the following diagram:

	A	B	C
1	DATA_BLOCK DB 1		
2	TITLE =		
3	VERSION : 0.1		
4			
5			
6	STRUCT		
7	Datatype := W#16#1 ;		
8	x1 : REAL := 1.000000e+000;		
9	y1 : REAL := 5.000000e+000;		
10	x2 : REAL := 2.000000e+000;		
11	y2 : REAL := 6.000000e+000;		
12	x3 : REAL := 3.000000e+000;		
13	y3 : REAL := 7.000000e+000;		
14	x4 : REAL := 4.000000e+000;		
15	y4 : REAL := 8.000000e+000;		
16	END_STRUCT;		
17	BEGIN		
18	END DATA_BLOCK		
19			
20			
21			
22			

Fig. 4-40 Example of a table in MS Excel with inserted structural data and tabular values

(3) Saving as STL [AWL] file

Finally, the correctly formatted file only has to be saved as text file with the extension *.AWL. In this case, the following should be selected in MS Excel "File → Save as...". "Formatted text (separated by blanks) (*.prn)" file type should be selected and the table example should be saved under a freely selectable name and location.

"Save as" window in MS Excel with the appropriate selection is shown in the following diagram:

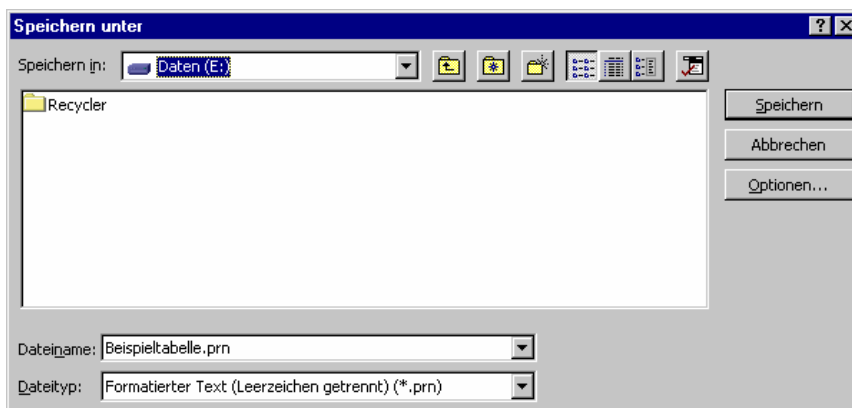

Fig. 4-41 An example of a table in MS Excel saved as text file (*.prn)

After the file has been saved, the file type should be changed from *.prn to *.awl. This file can then be opened with any text editor.

The following diagram shows the table example as STL [AWL] file, opened in the standard Windows text editor:

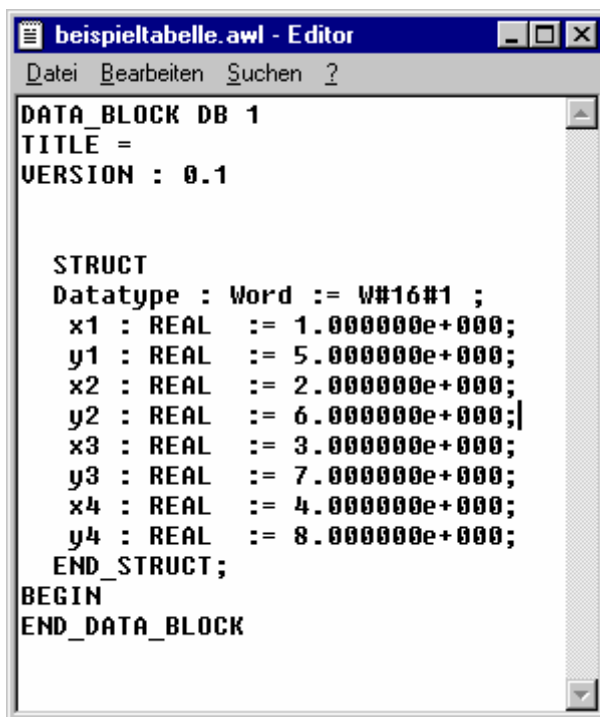

Fig. 4-42 Table example, saved as *.awl file, opened in the text editor

This file can only be used as external source file in STEP7 for a DB.

Incorporating the table as source file

Using the file example "BEISPIELTABELLE.AWL", generated above, the individual steps to incorporate an externally generated table in a DB will now be explained.

HINWEIS

In addition to specifying the tabular values, it is especially important to specify the name of the DB. A DB is subsequently generated using the name specified in the file.

In the above file example, "DB1" is specified as DB name in the first line. (refer to Fig. 10)

Now, an external source is inserted in the STEP7 configured software in the S7 program under "Sources". After selecting "Sources", the context-sensitive menu can be called-up by clicking in the righthand partial window with the righthand mouse key. An external source should be inserted here as new object.

The procedure is shown in the following diagram:

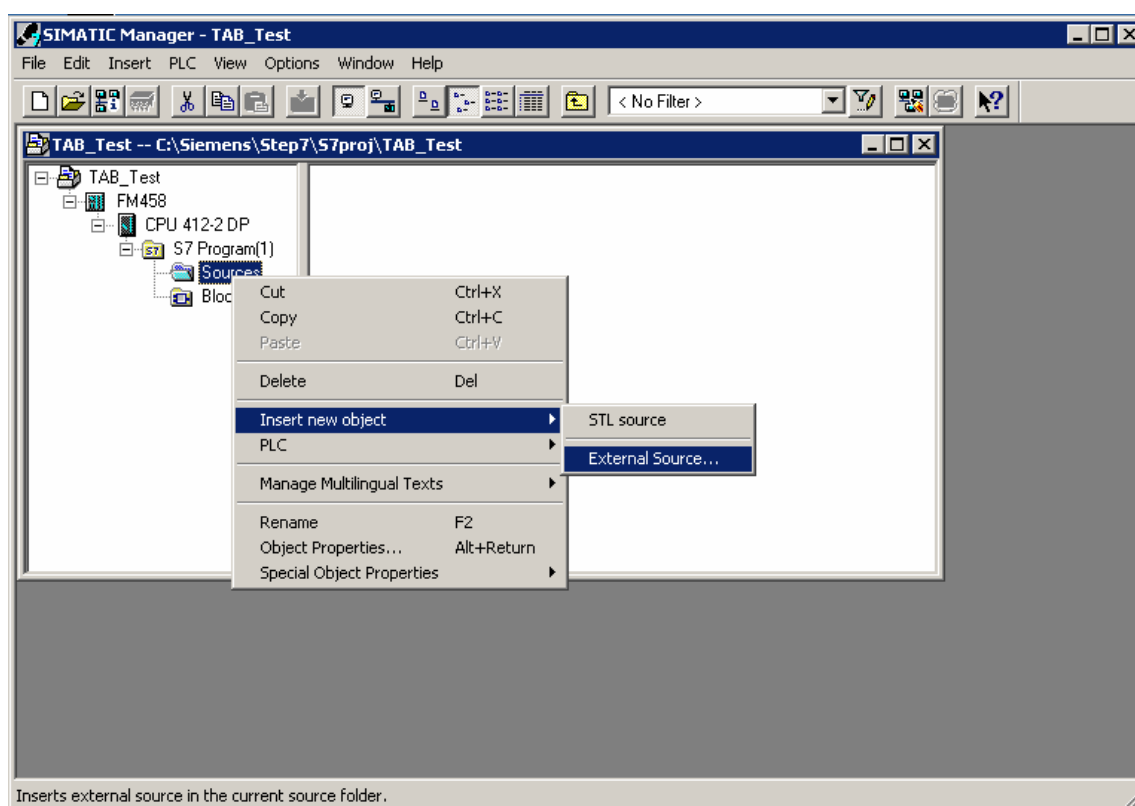

Fig. 4-43 Inserting an external source in STEP7

The STL [AWL] file, generated above, is selected as source file. The following diagram shows the file selection window:

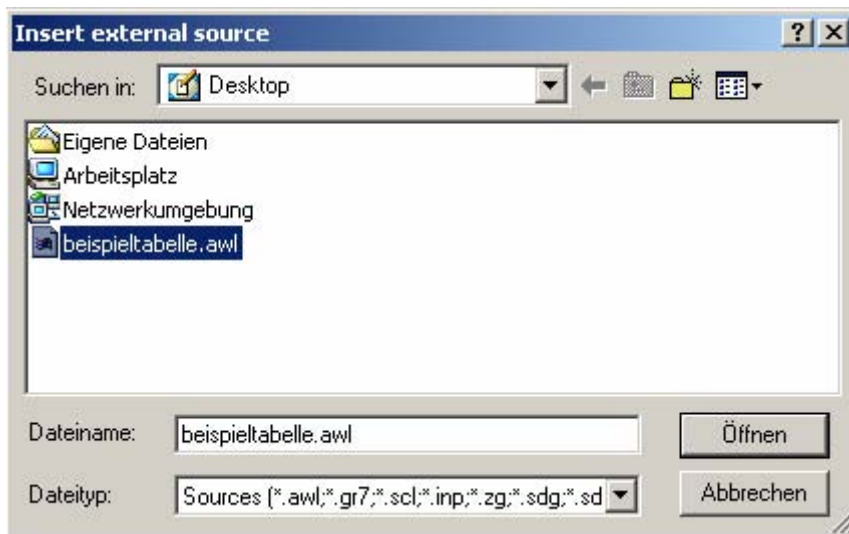

Fig. 4-44 Selecting the file to be inserted in STEP7 as external source

The selected file is opened (in this case: BEISPIELTABELLE.AWL). It now exists as source file in the configured software under "Sources". It is selected there and is opened.

The file example, available under "Sources" and its context-sensitive menu is shown in the following diagram:

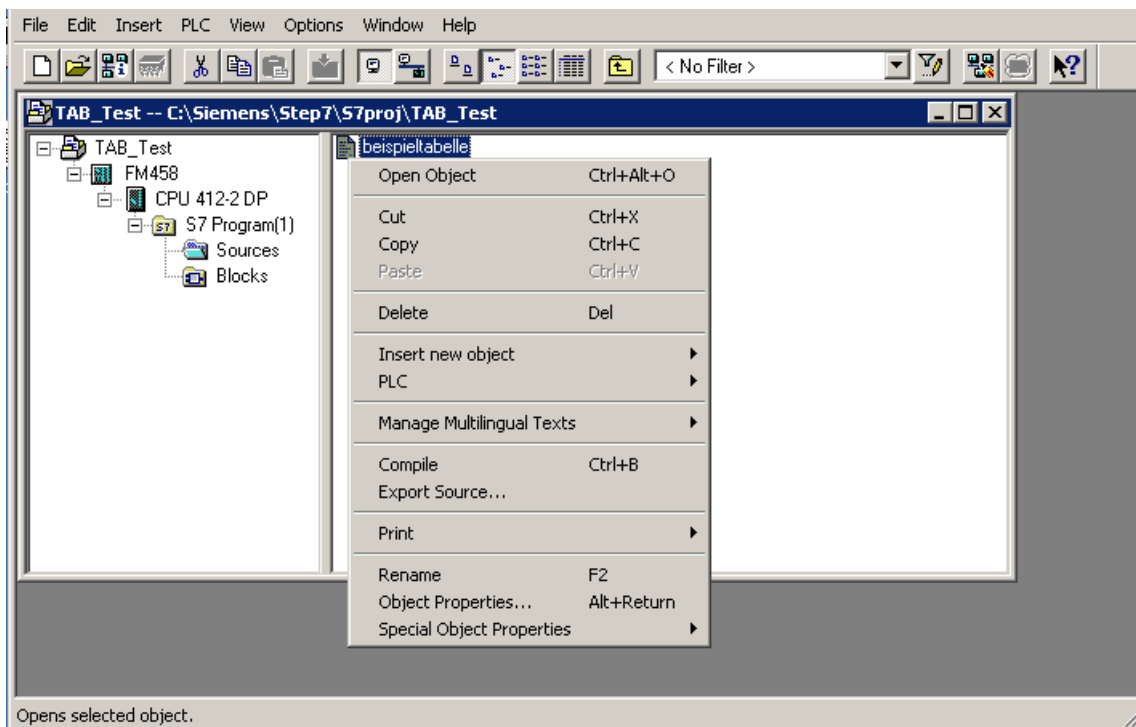

Fig. 4-45 Generated source file in STEP7

After the file has been opened, it can be edited in the "LAD/STL/CSF" program. There it can be compiled via "File / Compile".

The procedure is shown in the following diagram:

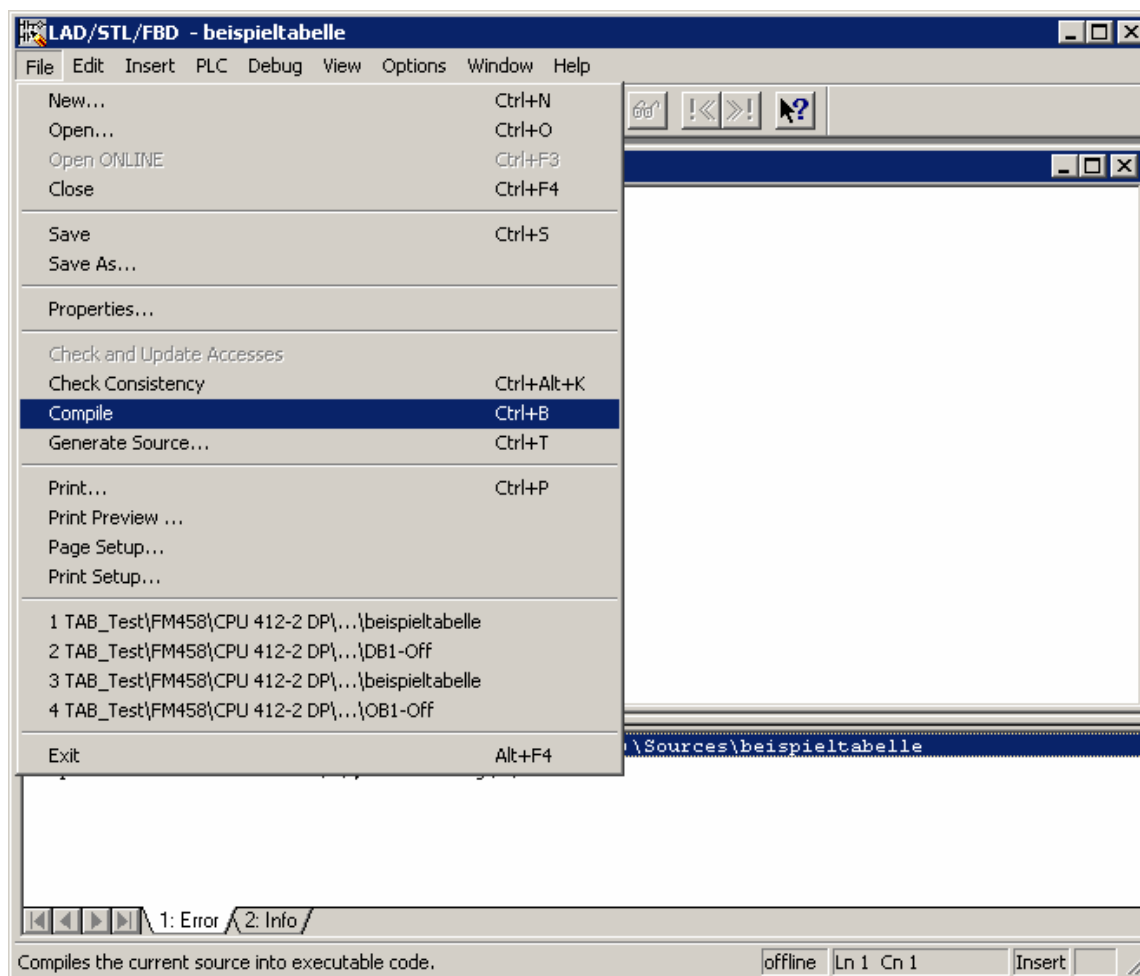

Fig. 4-46 Compiling the source file in the "LAD/STL/CSF" application

After the file has been successfully compiled, a new DB is available in the configured software. The name of the DB corresponds to the name specified in the header line of the file.

The following diagram illustrates the newly generated DB in STEP7 configured software under "Blocks":

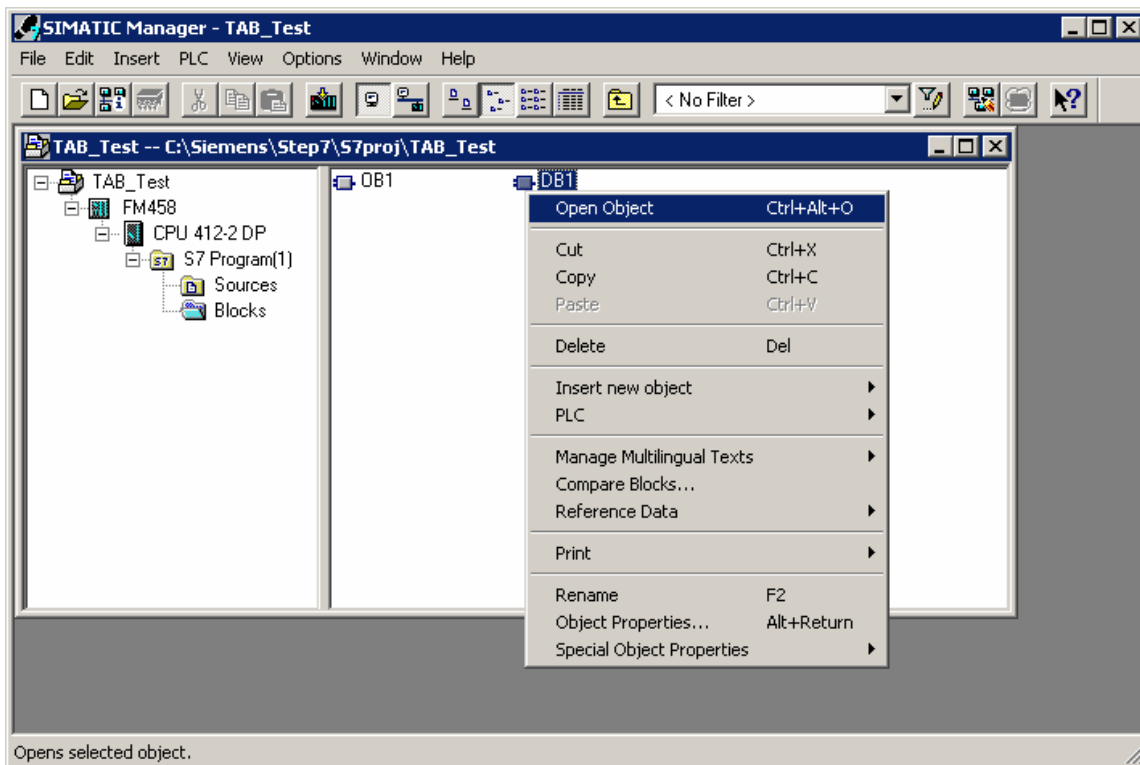

Fig. 4-47 Newly generated DB after compiling the source file

In order to check the contents of the DBs, it can be opened in the "LAD/STL/CSF" program. "Data view" should be selected in the "View" menu to display the initial (starting) values as well as the actual values.

The contents of the opened DB is illustrated in the following diagram:

Fig. 4-48 Contents of the newly generated DB in the "LAD/STL/CSF" application

4.7.3.3 Subsequently downloading tabular values into a DB

If tabular values are to be subsequently downloaded into the DB, because the table is too large and there is not sufficient user memory for several DBs, then the table should be transferred to the SIMATIC FM 458-1 DP application module in several sub-sets of the table. To do this, the table must be split-up into sub-sets of the table. The size of the individual sub-set tables should be selected so that the user memory of the S7-CPU is not exceeded. The individual table sub-sets are then transferred one after another.

HINWEIS

It is especially important that the individual table sub-sets are transferred in the sequence of the value pairs. If they are transferred in the incorrect sequence, then the tabular values will not be correctly available in the configured software.

There are two possibilities:

- Manually enter the individual tabular parts at the DB in the "LAD/STL/CSF" application and then transfer this part of the table
- Generate individual source files with different names for each table sub-set and after being successfully linked-into the DB one after the other, then transfer

Manual entry

In order to subsequently download tabular values into a DB manually, the following steps should be carried-out:

- The appropriate DB should be opened by double-clicking in the "LAD/STL/CSF" application.
- The existing tabular values should be replaced by entering the value of the subsequent tabular section.
- The DB should be saved.
- The values of the table sub-sets can now be transferred.

Generating several source files

The following steps have to be carried-out when subsequently downloading tabular values into a DB by generating several source files:

- The same DB name should be specified in the header of the individual source files (*.AWL).
- The individual files may not exceed the memory size of the DB.
- The file names are best numbered in an increasing sequence.
- The individual files are now linked-in as source files as described above. However, they are still not compiled.
- The first source file is compiled and the tabular values, now available in the DB, transferred.
- The second source file is compiled so that its tabular values are now available in the DB. These are now transferred to the S7 control system.
- Analog to this, the other source files are compiled and transferred one after the other.
- After the last table sub-set has been transferred, the LASTDB connection should be set from 0 to 1. This signals that the table has been transferred.

4.7.3.4 Structure of the data telegram for TCP/IP or DUST1 connection

If the communications link involves a TCP/IP or DUST1 coupling, then the data telegram structure must be carefully observed. This is described in the following. The data telegrams are "generated" using the function blocks CTV and CRV.

The data telegram is defined so that all of the tabular values can be transferred in a data block as well as in several data blocks.

The structure of a data block is shown in the following table:

Data type	Description
char [4]	Telegram ID Each table telegram is identified with the "TAB0" ID
u_int16	Telegram commands (bit-coded) 1: New table (rising edge, from 0 -> 1) 2: End of table
u_int16	Data format (REAL=1, DINT=2)
u_int32	No. of the actual data block
u_int32	No. of tabular values (X and Y values) The number of values must always be an even number. This means that always the same number of X and Y values are transferred.
u_int32 [56] / float [56]	Array with tabular values. (X and Y values, always alternating)

The TAB or the TAB_D sends an acknowledgement to the sender for each data block received.

The structure of the acknowledge telegram is shown in the following table:

Data type	Description
char [4]	Telegram ID Identifies each table telegram with the "TAB0" ID
u_int32	No. of the actual data block
u_int32	Status / error numbers 0xB210 OK (data block is o.k.)

HINWEIS

New table data is now transferred into the inactive table if the "New table" command is set.

After the "End of table" command has been received, all additional table data are rejected until the "New table" command is received.

4.7.4 Automatic mode: Memory card

Table values can be combined to form components using the D7-SYS additionalComponentBuilder (this is included in D7-SYS V5.2 plus SP1). These components can be downloaded as additional objects on the memory card. From there, they are read-out using the TAB or TAB_D function blocks.

One or several table files are imported in the D7-SYS additionalComponentBuilder, which then combines these files to form a component file (download file), which can then be downloaded onto the memory card.

The D7-SYS additionalComponentBuilder (aCB) does not check the contents of the files. The tables are an exception to this rule. The contents of these table files are checked. If the table file has an erroneous structure, then aCB immediately flags this.

The procedure from generating a table file up to configuring the function blocks is explained in the following sections using an example.

4.7.4.1 Generating a table file in the csv format

The table values are generated as required using a table calculation program (e.g. Excel).

The figure displays two side-by-side Microsoft Excel windows. The left window, titled 'Microsoft Excel - Table1.xls', shows a spreadsheet with columns A and B. Column A contains values from 1.00 to 2.50 in increments of 0.10. Column B contains values from 1.00 to 6.25 in increments of 0.25. The right window, titled 'Microsoft Excel - Table2.xls', shows a spreadsheet with columns A and B. Column A contains values from -1 to 0.5 in increments of 0.1. Column B contains values from 1 to 0.25 in increments of 0.09. Row 11 in Table2 contains scientific notation: -1.38778E-16 and 1.92593E-32.

Fig. 4-49 Tables values in Excel

Conditions

The table files must fulfill the following conditions:

- A table file may only comprise two columns – if additional columns are included in the table, an error message is displayed in a dialog window.
- Both of the columns must contain the same number of values. If this is not the case, then the D7-SYS additionalComponentBuilder displays an error message in a dialog window and the table values are rejected.

The D7-SYS additionalComponentBuilder expects the following data format:

- [+/-] xxx.yyy – real value, decimal places are specified using a „.“ (e.g. 145.123)
- [+/-] xxx,yyy – real value, decimal places are specified using a „,“ (e.g. 145,122)
- [+/-] xxx.yyyE +/-mm – real values shown as an exponent, decimal places are specified using a „.“ (e.g. 145.122E+12)
- [+/-] xxx,yyyE +/-mm – real values shown as an exponent, decimal places are specified using a „,“ (e.g. 187,122E+12)

For the „Table DINT“ type description:

- [+/-]xxx – Integer or double integer (e.g. 145)

The following conditions still apply for the table files:

- ASCII files
- The table columns are separated using a semicolon or tab character
- Lines are separated using a line break or semicolon

Saving tables

Tables, which are generated using MS Excel and are saved in the *.csv format or as "Text (Tabs separate)" fulfill these conditions.

The following diagram shows two example files with table values which were saved in the csv format:

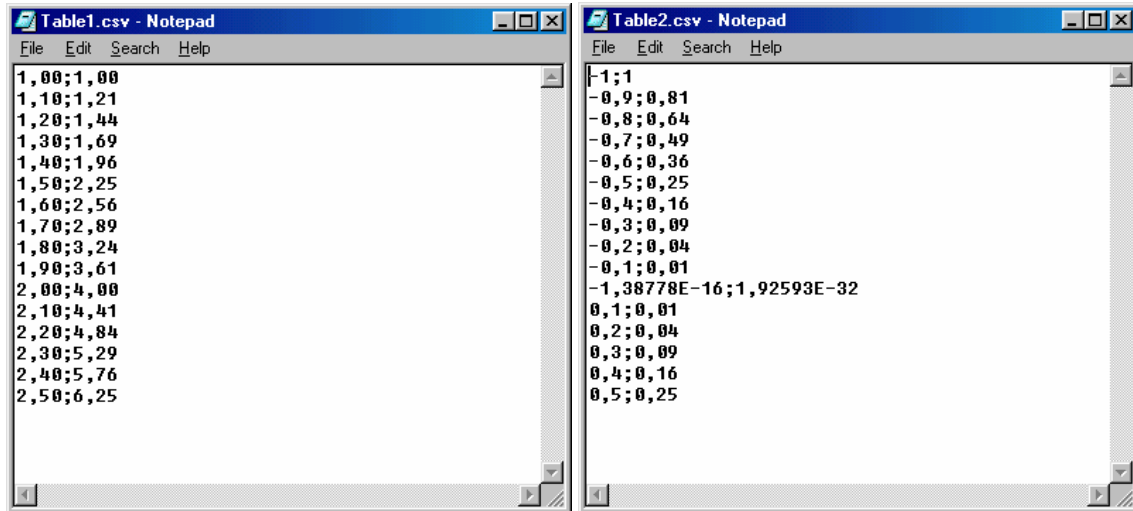

Fig. 4-50 Table values which were separated using semicolons (*.csv format)

4.7.4.2 Working with the D7-SYS additionalComponentBuilder

After the table files were saved in the csv format, they can be imported in the D7-SYS additionalComponentBuilder.

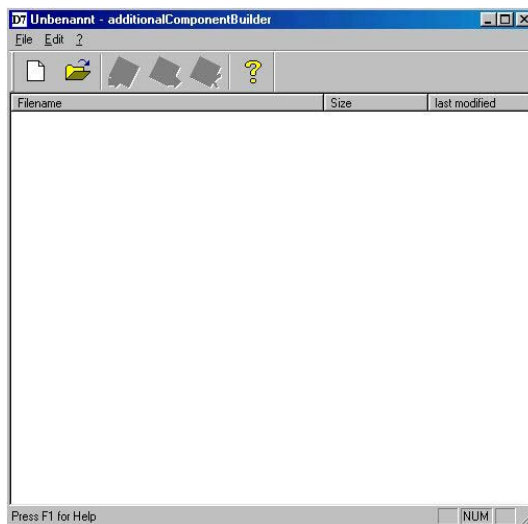



Fig. 4-51 D7-SYS additionalComponentBuilder

In the next step, a new component file is set-up with . To start, the properties are specified in the following dialog field.

New component

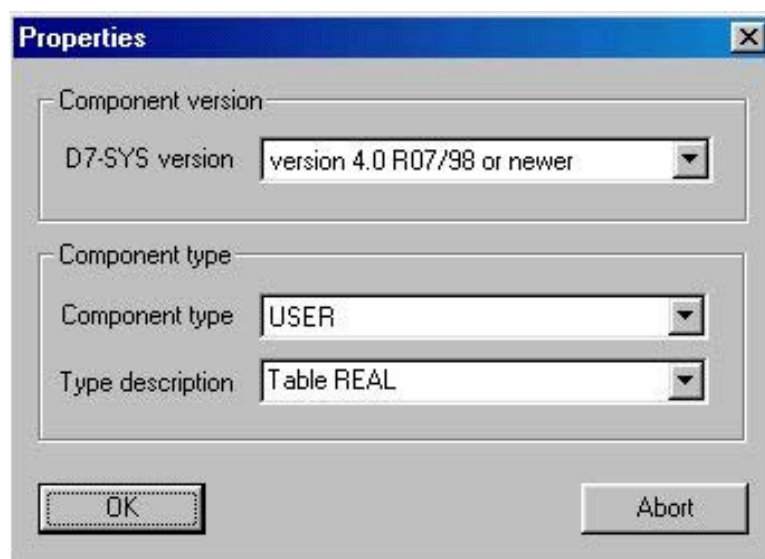

Fig. 4-52 Setting the properties

The following settings should be made:

These properties cannot be changed at a later time and have a gray background.

- **D7-SYS version**
List box, in which the version is specified for which the components should be generated
- **Component type**
List box with the fixed entries "USER", "IT1" and "IT2". "USER" is the default value

The entries have the following significance:

- USER = Component file generated by the user,
e.g. table files
- IT1/IT2 = System component file for ITSP modules

- **Type description**
List box with the "Table REAL" and "Table DINT" entries. "Table REAL" is the default value for the "USER" component type. "Table DINT" is used for tables in the DINT format.

The entries have the following significance:

- REAL table: Table file with REAL data type
- DINT table: Table file with double integer data type

A new type description can be entered in the list box and acknowledged using RETURN. This new type description is then transferred into the list box and can be selected from the list box the next time.

Saving

The new component file can be set-up after the settings have been completed.

The new component file is, as standard, set-up in C:\temp. If another memory path is specified, then when the program re-starts, this is used as standard memory path.

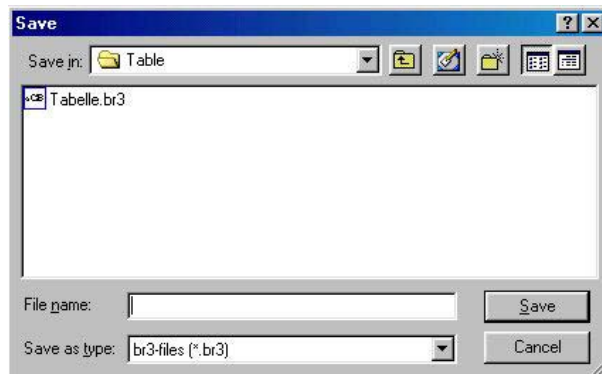

Fig. 4-53 Saving the new component file

Table files can now be added. A file selection window is opened using



with which the required table files can be selected.

NOTE

Only tables with a uniform value format can be included in a component with the "table" type description! This means that a REAL table only contains tables with REAL values.

The following diagram shows the contents of the D7-SYS additionalComponentBuilder after importing the two generated table files:

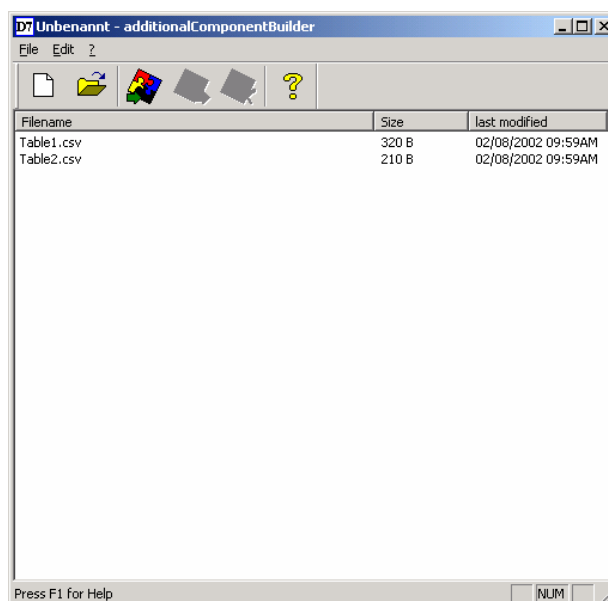

Fig. 4-54 D7-SYS additionalComponentBuilder with imported table files

Additional table files can be added or imported or deleted at any time. The D7-SYS additionalComponentBuilder automatically takes-over the management of the table files and saves the modified component files.

Opening

When opening existing components, "C:\temp" is the standard search path of the D7-SYS additionalComponentBuilder. If another path is selected, when the program re-starts, this is used a standard search path.

4.7.4.3 Downloading

After the component file was set-up with the D7-SYS additionalComponentBuilder, it can be downloaded into the general download dialog box.

(1) Opening the download dialog box in D7-SYS with "target system → Download"

Using this dialog box, the current configuring can download the optional components into a memory card (offline/online).

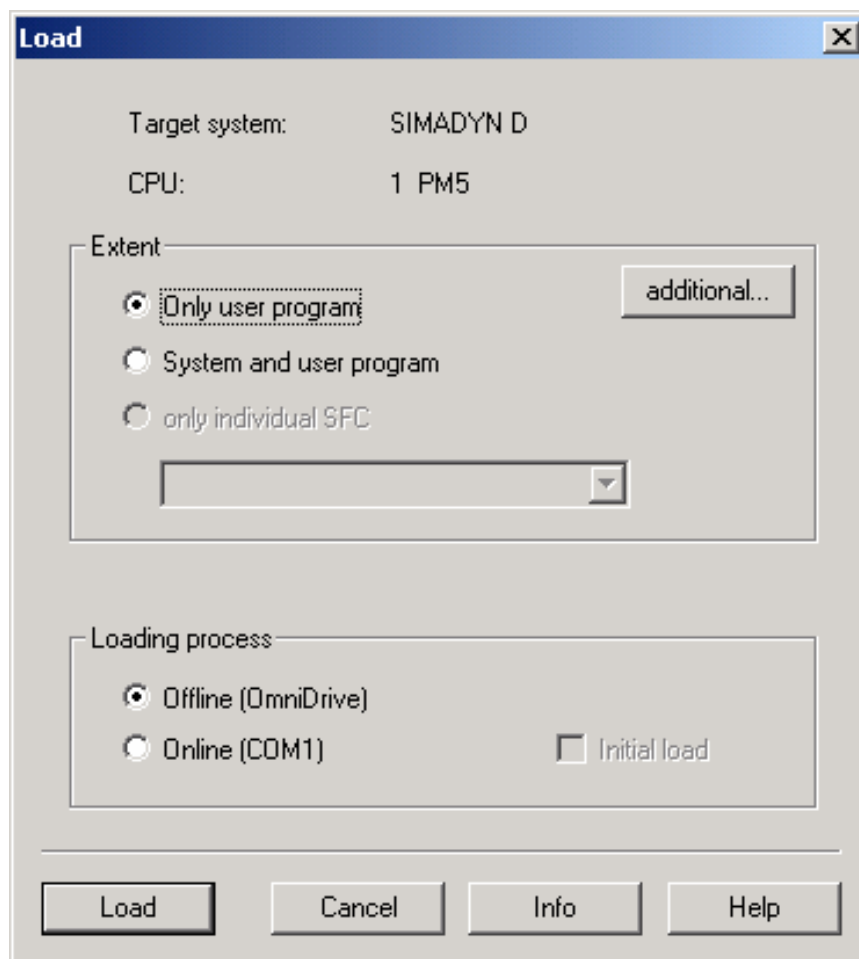

Fig. 4-55 Download dialog box via target system → Downloading into D7-SYS

(2) Opening the dialog box for optional components

A maximum of 2 components can be selected. A file can be selected for the selected components by clicking on the “NEW” button.

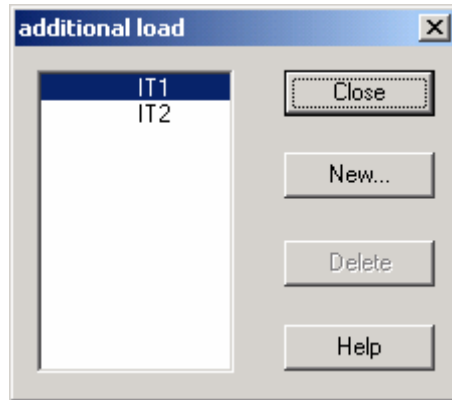

Fig. 4-56 Selection dialog box for optional components, e.g. table data

(3) A file selection dialog box opens to select additional components

The component file, previously created using the D7-SYS additionalComponentBuilder, is now assigned the component IT1 and during the next download operation, is written into the memory card.

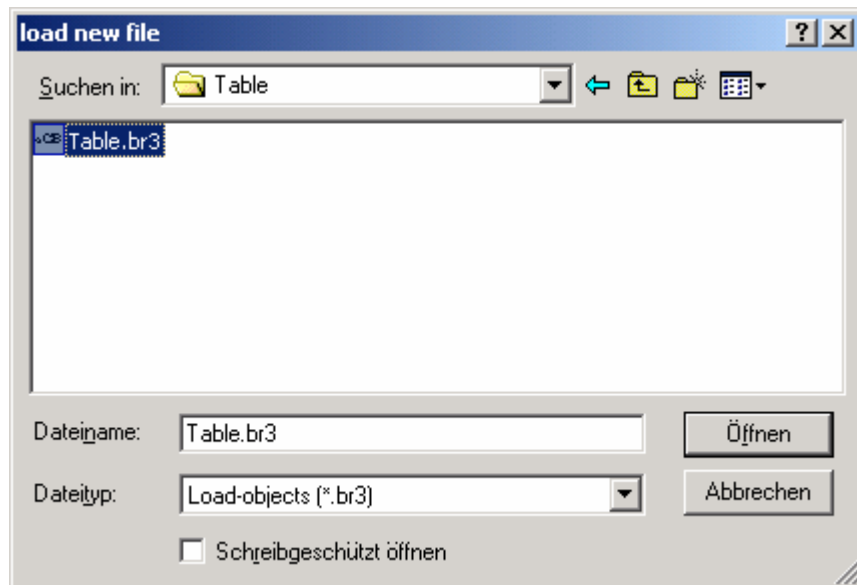

Fig. 4-57 Downloading a component file

4.7.4.4 Configuring the function blocks

For the "automatic mode, memory card" mode, only the TAB and/or TAB_D function blocks must be configured, depending as to whether table values, REAL data type and/or DINT data type have to be managed. Each table may only contain values of one data type. If several tables are to manage various data types, then a TAB or TAB_D should be configured for each table.

The TAB and TAB_D function blocks should be configured in a sampling time greater than or equal to 32ms. The following connection settings are required:

- CTS=** 0
- US =** Not assigned
- NAM =** Name of the table file (with file name extension which was defined when "saving", e.g. MS Excel)
- AUT =** 1 (automatic mode activated)

The configuring is shown in the following diagram:

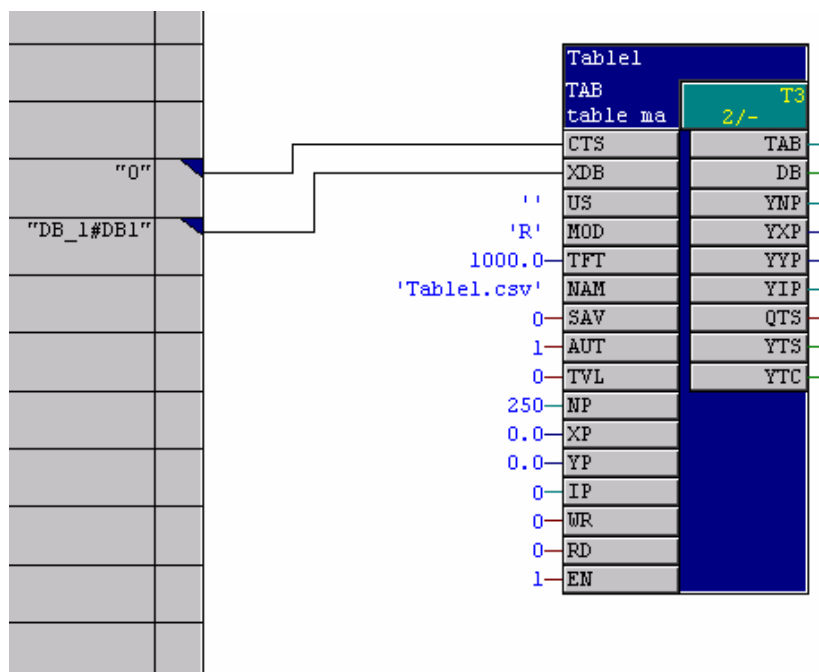

Fig. 4-58 Configuring the TAB function block

The table function blocks for 2 tables are shown in the following diagram. The table values, which are now managed by the function blocks, can now also be used by additional function blocks, e.g. FB TABCAM.

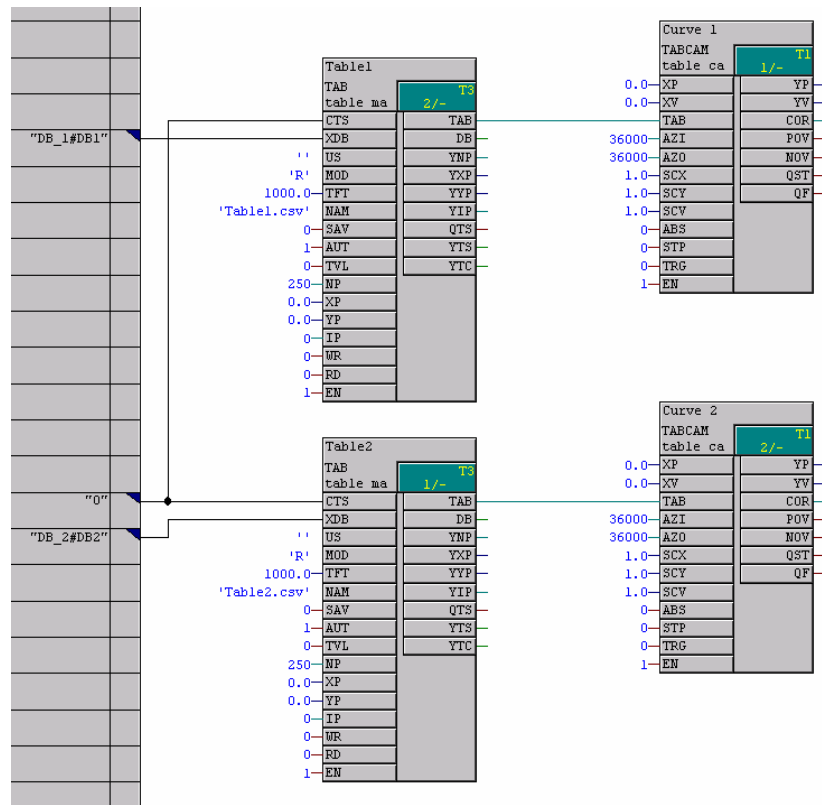

Fig. 4-59 Configuring example

4.8 Parameter access technique for D7-SYS

4.8.1 General description of the parameter functionality information

By appropriately parameterizing using operator control devices for parameters at the block I/O:

- Reading values
- Changing values
- Changing values and saving in the CPU change (cache) memory
- Changing interconnections using BICO technology
- Changing interconnections and saving in the CPU change (cache) memory
- Reading parameter descriptive elements

Hardware platforms

You can be used for the Parameter access technique following hardware platforms:

- T400 technology module
- Application module FM 458-1 DP
- SIMADYN D standard CPUs

NOTE

Masterdrives operator control devices, for example, OP1S or "DRIVE ES"/"DRIVE Monitor" can be used for parameterization.

4.8.1.1 Parameters

When the parameter access technique for D7-SYS you designate block inputs or outputs as parameter.

There are two types of parameters:

- **Monitoring parameters**
 - These can be configured at the inputs and outputs of blocks
 - Values can only be read.

- **Setting parameters**

- are configured at block inputs
- values can be read, changed and saved in the change memory.
- interconnections to other blocks can be changed using BICO technology

NOTE

You cannot change parameter values if \$ signals or virtual connections are configured at the block inputs.

Connection data types for parameters

You can configure the following D7-SYS connection data types of the blocks as parameter:

D7-SYS connection data type in CFC	Bool	Integer	Double Integer	Word	Real	SDTime
Parameter data type in the parameter description	O2	I2	I4	V2	I4	I4

Configuring parameters

A maximum of 2000 different parameters are available. Each parameter may only be assigned once. Parameters are configured in CFC as follows:

Designate the block connection using a pseudo comment @TP_bnnn, with

- b: range identification "H", "L", "c" or "d"
 - designates the number range
 - "H" or "L": I/O can only be read and changed
 - "c" or "d": Connections can only be read
- nnn: three-digit parameter number
 - 000 to 999

NOTES

- A parameter number may only be assigned once (checked using the CFC).
- A pseudo comment may not be configured at a chart interface connection.
- A pseudo comment may not be configured at a block connection in a chart, which is to be compiled as block type.
- No more than one parameter may be configured as pseudo comment per block connection.
- A comment can include several pseudo comments, separated by blanks, followed by a "standard" comments text, e.g. "@TP_H089 @DATX ...".)

Accessing parameters

You can externally access parameters (e.g. from a higher-level control system such as SIMADYN D) as follows:

Pseudo comment	T400 Techboard	T400 baseboard / CPU modules in SIMADYN D subracks	Can be configured at connection	Connection	Significance
	Display operator control units	Display operator control units	O: Output I: Input		
@TP_dxyz	dxyz	rxyz	A / E	Any	Monitoring parameter
@TP_cxyz	cxyz	nxyz	A / E	Any	Monitoring parameter
@TP_Hxyz	Hxyz	Pxyz	E	None or OP connections	Setting parameter
@TP_Lxyz	Lxyz	Uxyz	E	None or OP connections	Setting parameter
@TP_Hxyz	Hxyz	Pxyz	A	Any	Monitoring parameter
@TP_Lxyz	Lxyz	Uxyz	A	Any	Monitoring parameter

Legend

- xyz:** Parameter number
- any:** Interconnected or not interconnected .
- OP connection:** Interconnected using global operands.

4.8.1.2 BICO technology for SIMADYN D

With MASTERDRIVES operator control devices, with BICO technology you can change interconnections between blocks. You can change configured software without using the CFC. You can change interconnections on a T400 technology board, Application module FM 458-1 DP or CPU module in a SIMADYN D subrack.



DANGER

- **BICO technology and the CFC test mode should not be used simultaneously.**
- **If you make online changes in the CFC test mode, then you must first re-compile before you use BICO technology. Changes made in the CFC only become effective on the display of the operator control device after compilation.**
- **If changes were made using BICO technology without saving them in the CPU change memory, then data consistency between the changes on the CPU and your configured software on the PC/PG are no longer guaranteed, and can no longer be established by updating the project. If you wish to avoid this inconsistent condition, you must first RESET the module before you use CFC in the test mode**

NOTE

If you have made interconnection changes using BICO technology, and then you activate the CFC test mode, a warning is displayed in the form of the "different software release" dialog box.

Data types for technological connectors

You can configure the following D7-SYS connection data types of the blocks as technological connectors:

D7-SYS connection data type in CFC	Bool	Integer	Double Integer	Word	Real	SDTime
Data type of the technological connector in the parameter description	O2	I2	I4	V2	I4	I4

Configuring technological connectors

In order that you can change interconnections between blocks using BICO technology, you must, in addition to the parameters, still configure technological connectors at block outputs in the CFC. You can use block outputs with technological connectors to change the interconnection using BICO technology.

Technological connectors are configured as follows:

Designate the block output with a pseudo comment @TC_nnnn, with nnnn: four-digit technological connector number 0000 to 9999

NOTES

- No more than one technological connector may be configured as pseudo comment per block output.
- A technological connector number may only be assigned once (checked using CFC).
- It is not permissible to configure a technological connector at a plan interface connection.
- It is not permissible to configure a technological connector at the connection (I/O) of a block in a chart, which is to be compiled as block type.
- A comment can include several pseudo comments, separated by blanks, followed by "standard" comments text, e.g.
"@TC_1389 @TP_H345 ..."

Reading parameters

You can read a parameter and output the value using an operator control device.

The output value corresponds to:

- for block I/O, interconnected with technological connectors, the number of the technological connector @TC_nnnn
- for block I/O which are not interconnected, the value of the block input or output

From the parameter documentation of a standard software package, you can identify whether the output value represents the number of a technological connector or the value of the block input. It is not possible to make this differentiation at the operator control device display.

Changing interconnections using BICO technology

Using BICO technology, you can only change existing interconnections between blocks, if these interconnections are configured as follows in the CFC:

- technological connectors @TC_nnnn are configured as pseudo comments at the block output,
- parameter @TP_Hnnn or @TP_Lnnn is configured as pseudo comment at the input of a block,
- the blocks are interconnected by connecting an input with pseudo comment @TP_Hnnn or @TP_Lnnn and an output with pseudo comment TC_nnnn.

The interconnection is changed using BICO technology, by entering, at the operator control device, the number of another technological connector @TC_nnnn as parameter value.

NOTE

-
- The maximum number of interconnections of different inputs which are changed with BICO technology, which are saved in the change memory, are, for
 - technology module T400: approx. 1600
 - Application module FM 458-1 DP: approx. 400
 - CPU module in the SIMADYN D subrack: approx. 400
 - Using BICO- technology, you can only change existing interconnections between block I/O, but you cannot delete them.
 - Using BICO technology, you cannot establish a new interconnection at inputs which are not connected.
 - Changes made to the interconnections of block I/O using BICO technology, are only effective when updating the project in the CFC, if they were saved.
 - For changes made to the interconnections of block I/O using BICO technology, when type checking the connections, the same rules apply as for CFC.
-



CAUTION

The pseudo comment @DATX is not supported by the CFC test mode. When changing an interconnection, where @DATX is available as pseudo comment at the block input, the value for this connection is updated again, but still maintaining the data consistency mechanisms. Thus, the pseudo comment @DATX is no longer valid.

Remedy: Re-compile and re-load the user program.

Examples

Interconnection possibilities using BICO technology and their significance:

Pseudo-comment	Connection-Type	Inter-connected with	Processed at the operator control device	
			Read	Write
@TP_L/H	I	Standard	Display value	Not possible
@TP_L/H	I	Flag	Display value	Change value
@TP_L/H	I	\$ signal	Display value	Not possible
@TP_L/H	I	Virtual inter-connection	Display value	Not possible
@TP_L/H	I	—	Display value	Change value
@TP_L/H	I	@TC_	Display the number of the @TC_	Interconnect to a new number of @TC_, if present
@TP_c/d	I	Any	Display value	Not possible
@TP_c/d	I	@TC_	Display value	Not possible
@TP_L/H	O	Any	Display value	Not possible
@TP_c/d	O	Any	Display value	Not possible
@TC_	I	—	Error message when compiling in the CFC	
@TC_	O	—	Source for interconnection using BICO technology	

Legend

- @TP_L/H:** Parameter @TP_Lnnn or @TP_Hnnn
@TP_c/d: Parameter @TP_cnnn or @TP_dnnn
@TC_: Technological connector @TC_nnnn
Standard: The output is not a flag, not a \$ signal and is not a virtual interconnection.
Any: Interconnected or not interconnected.
— : No interconnection.

Interconnections extending over different tasks

The number of newly generated interconnections between different tasks using BICO technology is limited. The largest of the following values applies for your application:

- Value 20
- 20 % of the already configured number of interconnections between tasks
- $0.25 \times$ number of the @TC_... technological connectors configured in task n.

4.8.1.3 Status-dependent parameter changes

If selected parameters are only to be changed when the system is in specific statuses, then you can configure the following functions blocks:

- Function block PSTAT
 - to configure a device status
 - by entering a password with the authorization level enabled
- Function block PLIM
 - defines the statuses and access levels in which a parameter may be changed

Additional information

on function blocks, refer to the Reference Manual "SIMADYN D Control system, Function Block Library".

4.8.1.4 Identifying SIMADYN D components

Reserved parameters

To identify components, "DRIVE Monitor" evaluates technology parameters d998 (1998) and d999 (1999).

d998	Device	Special feature
80	SIMADYN D, general	The parameter range, especially extended for SIMADYN D up to 16 * 2000 parameters, applies. Parameters are possible in the basic device parameter range (0 .. 999). This means, an identification can result in a random product if a parameter just by chance coincides with the identification parameter and value of a drive converter/inverter.
134	T400 /	Parameter range = technology parameters (1000 .. 1999; 3000 .. 3999)
134	FM 458-1 DP/ SRT400	Parameter ranges, the function can be set at the central FB <ul style="list-style-type: none"> • BASEBOARD: 0 ... 999; 2000 ... 2999 • TECHBOARD: 1000 ... 1999; 3000 ... 3999

Procedure when identifying

Prerequisite: The user selects SIMADYN D or SRT400 and goes online with the device type.

Dependig on the selected device type, DriveMonitor checks the identification parameter d998. If the identification was successful, it is not checked as to whether another device can be recognized.

1. User selects SIMADYN D: If d998 = 80, then the identification routine is considered to have been successful.

2. User selects SRT400: If d998 = 134, then the identification routine is considered to have been successful. This means that the user can only address the technology, also independently of the basic device!

The following is still valid: Parameter d999 is optional to identify the software version and release of standard software packages.

d999	Software	Examples
1AB	Angular synchronism, version A.Bx (x is used to number compatible versions)	120 → SPA440 V2.0x 123 → SPA440 V2.3x
2AB	Axial winder, version A.Bx	221 → SPW420 V2.1x
3AB	Cross-cutter/closed-loop shears control, version A.Bx	310 → SPS450 V1.0x

If the device identification is not successful, then an attempt is made to identify the known devices types.

If "DRIVE Monitor" recognizes a different software (d999), the "Create database" option is listed in the "Device identification" dialog box. This means that a specific database can be set-up.

4.8.1.5 Units and unit texts

In order that you can assign *units* (physical quantities) to an input or output, you must configure a text string for the block I/O from the table below.

Physical quantity	Units	Text string to be configured
Length	Meters	m
	Millimeters	mm
	Kilometers	km
	Micrometers	um
Surface	Square meters	m ²
	Square millimeters	mm ²
	Square kilometers	km ²
Volume	Cubic meters	m ³
	Liters	l
Time	Seconds	s
	Minutes	min
	Hours	h
	Days	d
	Milliseconds	ms
	Microseconds	us
Force	Newton	N
	Kilo newtons	kN
	Mega newtons	MN
Pressure	Pascal	Pa
	Kilopascal	kPa
	Millibar	mbar
	Bar	bar
Weight	Kilograms	kg
	Grams	g
	Milligrams	mg
	Tons	t
Energy, work	Joules	J
	Kilo joules	kJ
	Mega joules	MJ
	Watt hours	Wh
	Kilowatt hours	kWh
	Megawatt hours	MWh

Physical quantity	Units	Text string to be configured
Active power	Watts	W
	Kilowatts	kW
	Megawatts	MW
	Milliwatts	mW
Apparent power	Volt-ampere	VA
	Kilovolt-ampere	kVA
	Megavolt-ampere	MVA
	Millivolt-ampere	mVA
Speed	1 / second	1/s
	1 / minute	1/min
	1 / hour	1/h
Angle	Radian	rad
	Seconds	"
	Minutes	'
	(old) degrees	grad
	New degrees (Gon)	ngrad
Velocity	Meters / second	m/s
	Millimeters / second	mm/s
	Millimeters / minute	mm/min
	Meters / minute	m/min
	Kilometers / minute	km/min
	Millimeters / hour	mm/h
	Meters / hour	m/h
	Kilometers / hour	km/h
Volume flow	Cubic meters / second	m ³ /s
	Cubic meters / minute	m ³ /min
	Cubic meters / hour	m ³ /h
	Liters / second	l/s
	Liters / minute	l/min
	Liters / hour	l/h
Mass flow	Kilograms / second	kg/s
	Grams / second	g/s
	Tons / second	t/s
	Grams / minute	g/min
	Kilograms / minute	kg/min
	Tons / minute	t/min
	Grams / hour	g/h
	Kilograms / hour	kg/h
	Tons / hour	t/h

Physical quantity	Units	Text string to be configured
Torque	Newton meter	Nm
	Kilonewton meter	kNm
	Meganewton meter	MNm
Temperature	Kelvin	K
	Degrees Celsius	C
	Degrees Fahrenheit	F
Enthalpy	Joule / Kilogram	J/kg
	Kilojoule / Kilogram	kJ/kg
	Megajoule / Kilogram	MJ/kg
Voltage	Volt	V
	Kilovolts	kV
	Millivolts	mV
	Microvolts	uV
Current	Ampere	A
	Milliampere	mA
	Kiloampere	kA
	Microampere	uA
Resistance (electrical)	Ohm	Ohm
	Milliohm	mOhm
	Kiloohm	kOhm
	Megaohm	MOhm
Ratio	Percentage	%
Absolute humidity	Gram / Kilogram	g/kg
Frequency	Hertz	Hz
	Kilohertz	kHz
	Megahertz	MHz
	Gigahertz	GHz
Referred torque	Newton meter / ampere	Nm/A
Acceleration	Meter / seconds	m/s2
	Meter / seconds	m/s3

4.8.2 Parameterizing on the Application module FM 458-1 DP

4.8.2.1 Terminology

- EXM448
EXM 448 communications expansion module of the FM 458-1 DP application module
- CBP2
COMBOARD/communications module for PROFIBUS DP
- “DRIVE ES” or “DRIVE Monitor“
Configuring software for drives and software for parameterization

4.8.2.2 Communications behavior

The FM 458-1 DP applications module can be configured in a SIMATIC S7-400 rack together with one or two communication expansion modules EXM 448. An option module, e.g. CBP2, can be inserted in the free slot X02. The CBP2 can be used to send and receive parameter tasks.

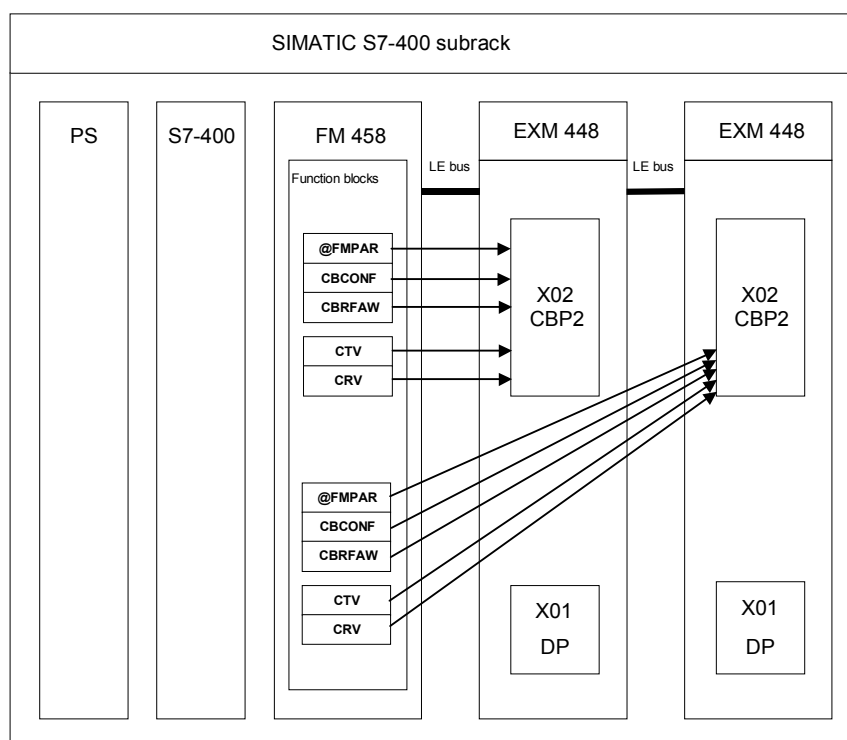

Fig. 4-60 Schematic diagram of the FM 458-1 DP application module with two EXM 448 communication-expansion modules

4.8.2.3 Generating the hardware configuration

You require the following hardware to parameterize the SIMATIC FM 458-1 DP modules:

- Subrack for S7-400
- Power supply module for the S7-400
- Central module (CPU) for S7-400
- FM 458-1 DP application module for SIMATIC S7-400
- EXM 448 communications-expansion module

In HW Config, the "Communications" plug-in module type must be activated for the properties of the EXM 448.

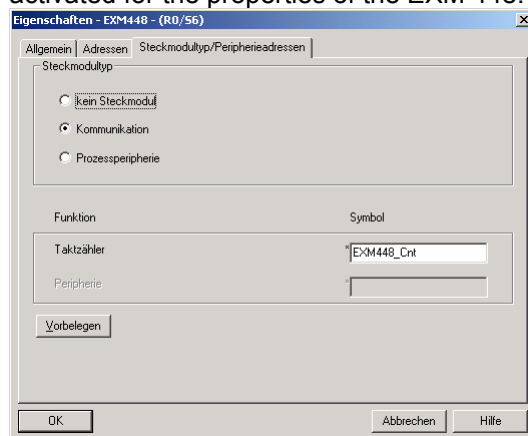

- CBP2 communications module (COMBOARD)

4.8.2.4 Functional scope

You must configure the following function blocks when parameterizing with "DRIVE Monitor":

- Central block @FMPAR
 - monitors the COMBOARD
 - processes the parameter tasks
- Function block CBCONF
 - used to configure a COMBOARD
 - used to display the diagnostic data of a COMBOARD

You can configure the following function blocks for additional functions:

- Function block CBRFAW

To receive the alarms from a COMBOARD

- CRV

The receive block distributes values from a data interface to the block inputs of function blocks of the same CPU.

Only max. 16 PZD words can be received and sent using a COMBOARD (e.g. CBP2).

- CTV

The function block only acquires and sends block output values from the CPU function blocks, on which it is configured.

4.8.2.5 Operator devices which can be connected

You can use the “DRIVE ES” or “DRIVE Monitor“ configuring software to parameterize the FM 458-1 DP application module

4.9 WinCC connection to FM458-1 DP channel (SIMATIC S7 Protocol Suite.CHN)

The chapter describes the procedure when configuring the access using WinCC to process variables (block connections of the SIMATIC S7-400 FM458-1 DP. The various configuring and coupling options are shown in the following diagram.

The coupling via TCP/IP using the FB property "OCM" functions (Operator Control and Monitoring) when creating an address book - is completely described.

The special features of the configuration version with function block "S7DB_P" that supersedes to create an address book is described in the following chapter.

An explanation is then given on how to use the MPI and PROFIBUS DP coupling types. (When using the PROFIBUS DP coupling for visualization purposes, it should however be taken into account that this coupling - generally used as fast drive coupling - is possibly slowed down by the HMI signals.)

The use of the D7-SYS-OS engineering tool (WinCC mapper) is then explained.

Overview - communication and configuring options
WinCC – FM458-1DP

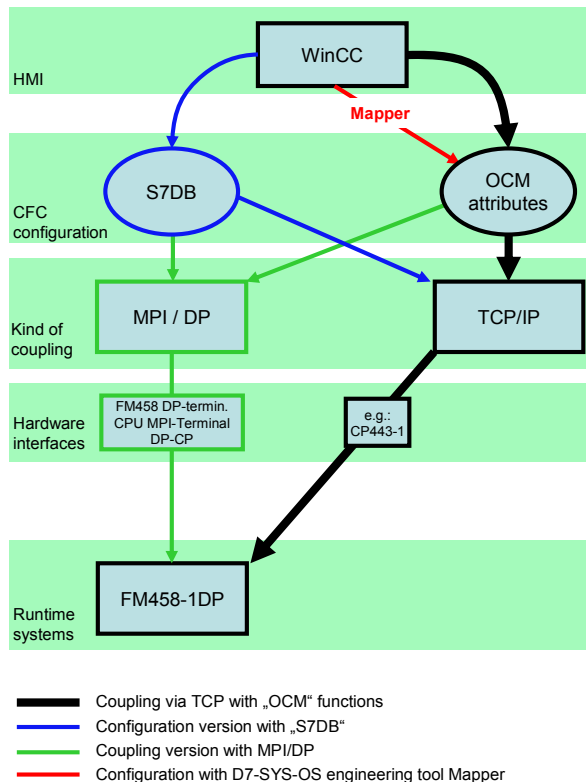

4.9.1 Coupling via TCP/IP with "OCM" functions

This chapter describes the procedure when configuring the WinCC access to process variables (block connections) of the SIMATIC S7-400 application module FM458-1 DP.

4.9.1.1 Configuring the coupling-relevant S7 hardware

A CP443-1 ADV can be configured as communication module for the TCP/IP coupling.

To change the IP address, click on the Properties button. The IP address can then be changed in the window that opens.

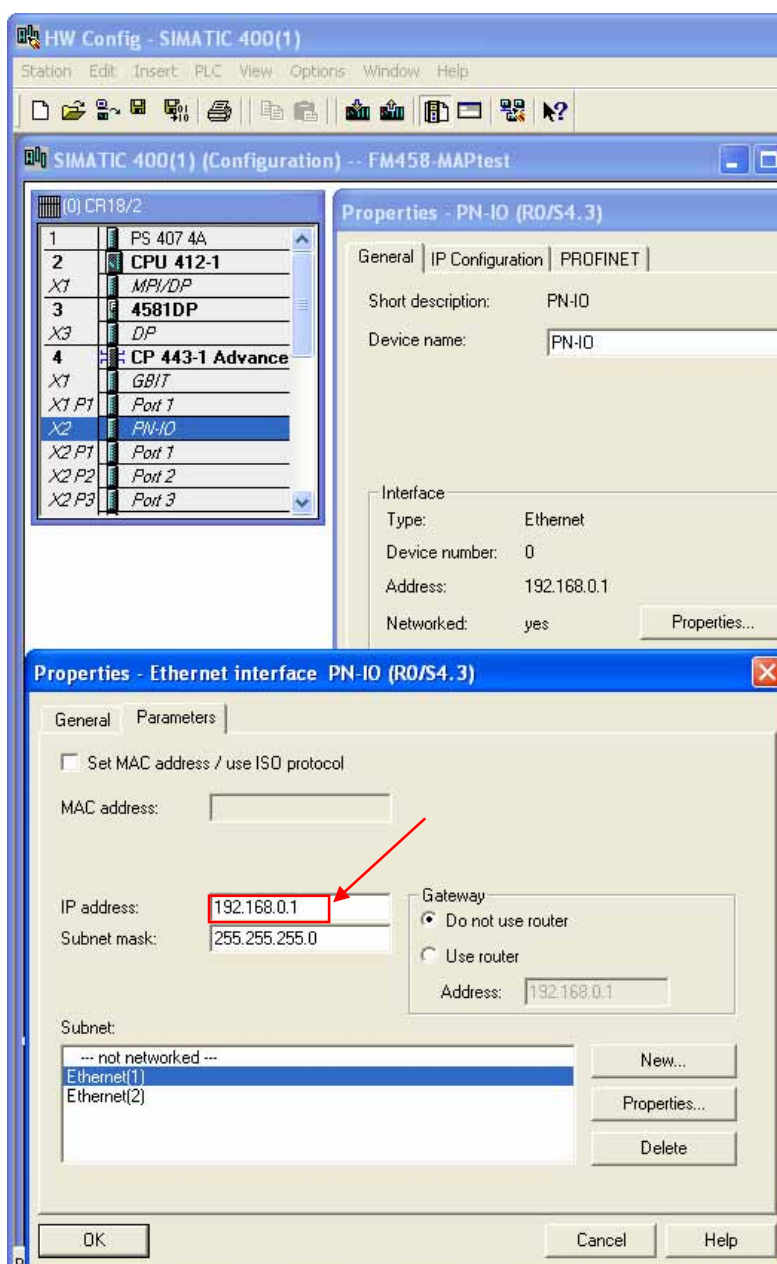

4.9.1.2 Configuring the CFC, marking the function block connections and creating the address book

The block connections, which must be handled and monitored using WinCC must, initially, be marked in the CFC charts as OCM-capable. To do this, you must proceed in the following steps:

1. Open the Properties dialog box of the block, set the checkmark for "OCM possible" and then press the "Operator C and M" button (refer to the following diagram).

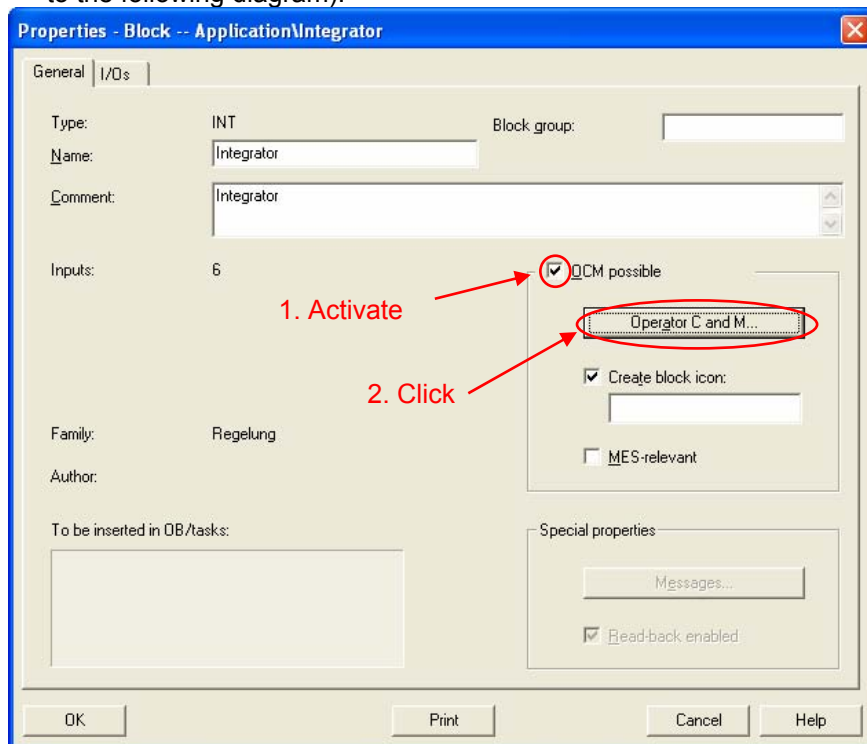

2. In the dialog box that is then displayed, set the checkmark for "Complete block structure", if all connections of the selected block are to be OCM-capable (refer to the following diagram). If only individual connections are to be selected then skip this step and continue with Step 3.

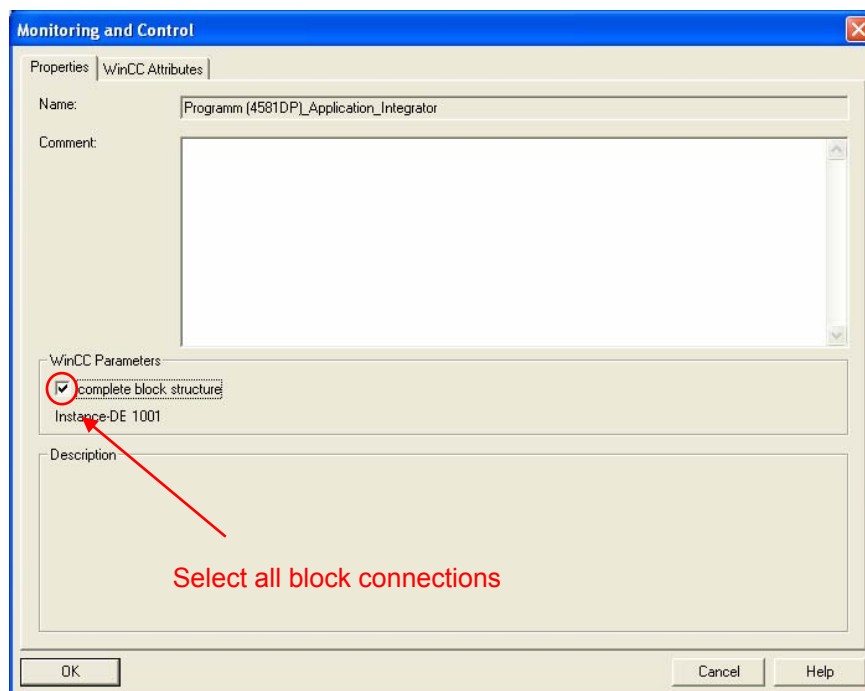

- Individually mark the OCM-capable connections in the WinCC attribute tab if not all of the connections are to be selected as in Step 2 (refer to the next screenshot).

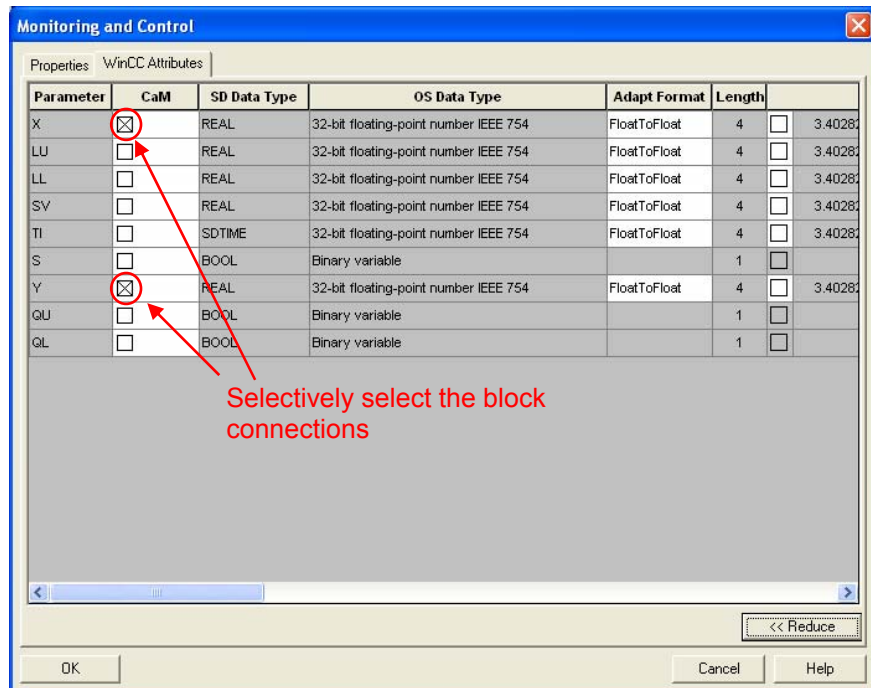
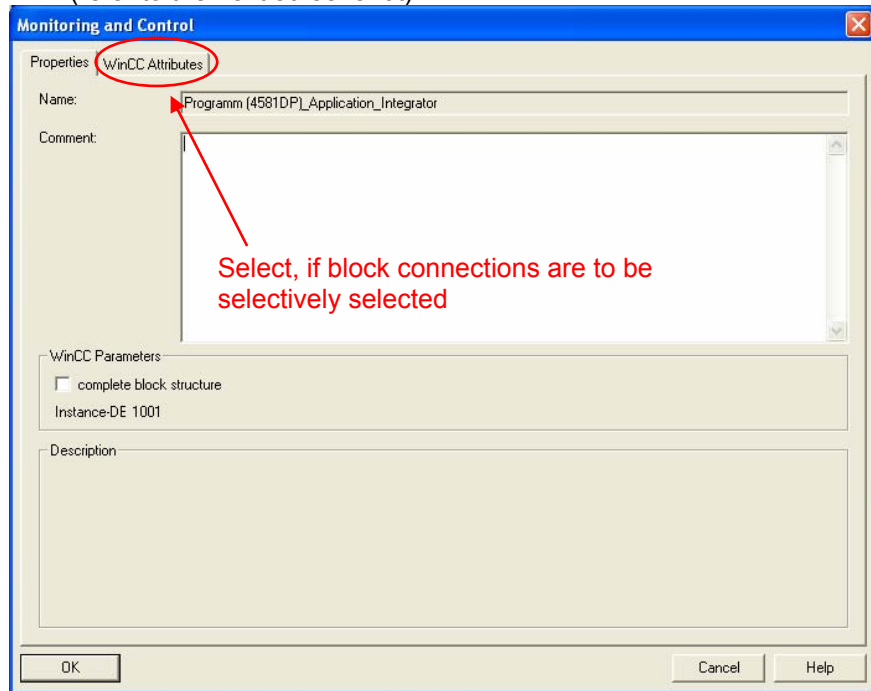

- Repeat steps 2 and 3 for all of the blocks that are to be controlled and monitored.

- Select the address book creation in the option dialog box to compile from CFC (**Options** → **Customize** → **Compile/download**) (refer to the next screenshot), in order to obtain the address information for the WinCC configuration.

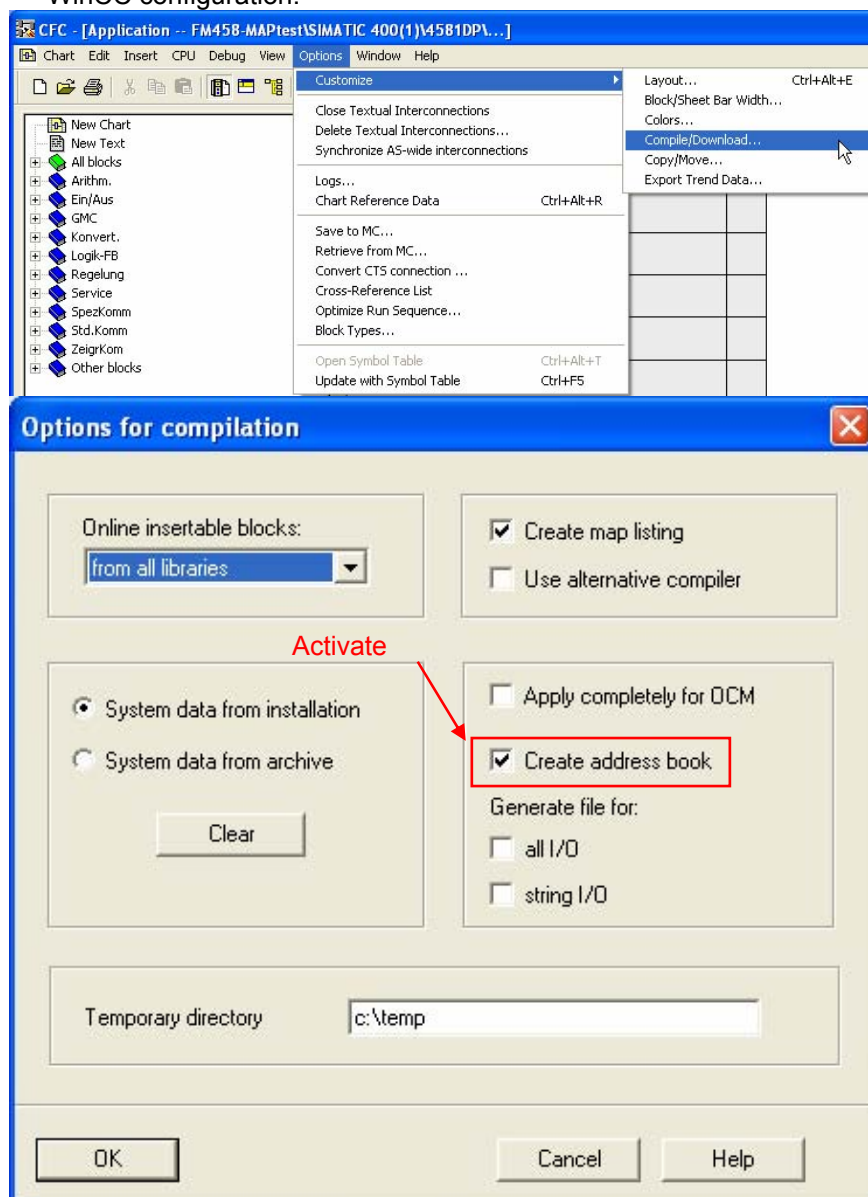

The address book is created when compiling. This then completes all of the activities necessary in the CFC charts. Access using WinCC is possible after it has been downloaded into the target system.

A "D7-SYS-OS engineering tool" – called "Mapper" in the following – is supplied with D7-SYS version 7.1. When run (executed), the tool sets-up a tag (WinCC variable) for each of the function block connectors that was marked.

If this mapper is used, then the workflow can be exited at this point and the work continued in Section 4.9.4.

The DB numbers and offsets of the individual connections, necessary to configure WinCC, can now be taken from the address book. A log can be found under the menu item **"Options>Logs"** in which information is provided as to where the address book has been saved.

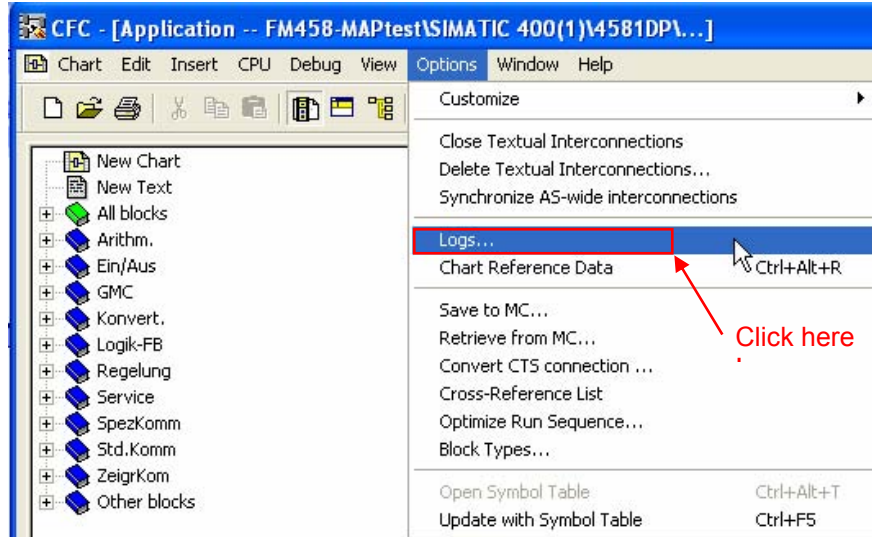

The location where the address book is saved is marked in the following log diagram:

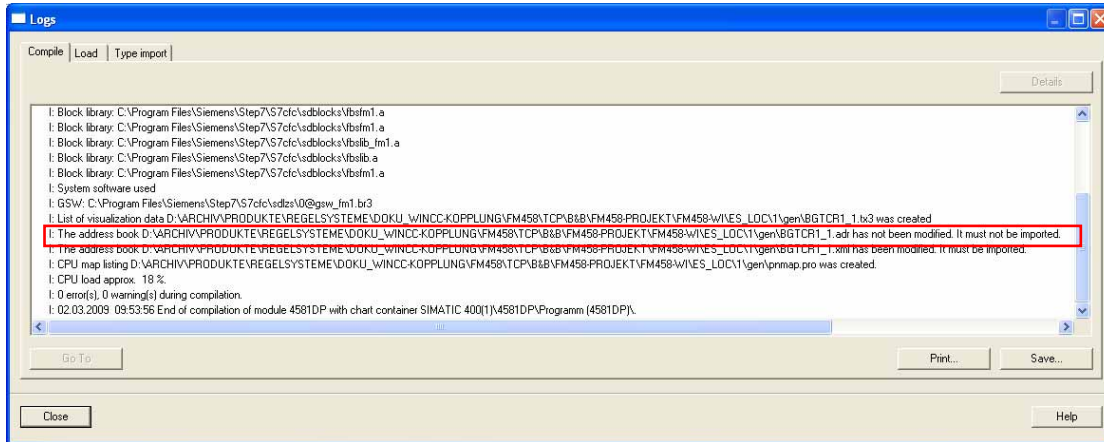

Only the WinCC-relevant information can be taken from the address book: Data block number and offset of the selected function block connections.

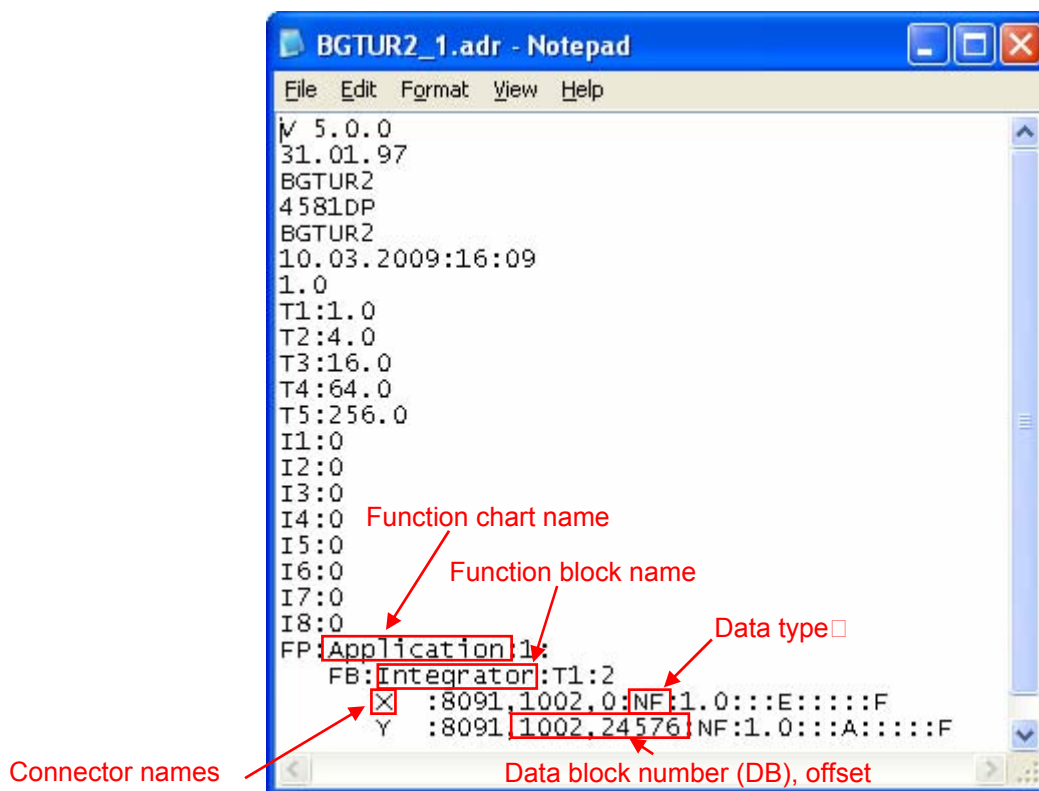

4.9.1.3 Configuring WinCC

When configuring WinCC, proceed in the following steps:

1. Start the WinCC Control Center.
2. Set-up a new project or open an existing one.
3. Set up the new driver by selecting **Tag Management** → **righthand mouse key** → **Add New Driver** → **SIMATIC S7 Protocol Suite.CHN** → **Open**. If this already exists, then continue with the next step.
4. Set-up a new connection by selecting **TCP/IP** → **righthand mouse key** → **New Driver Connection**.

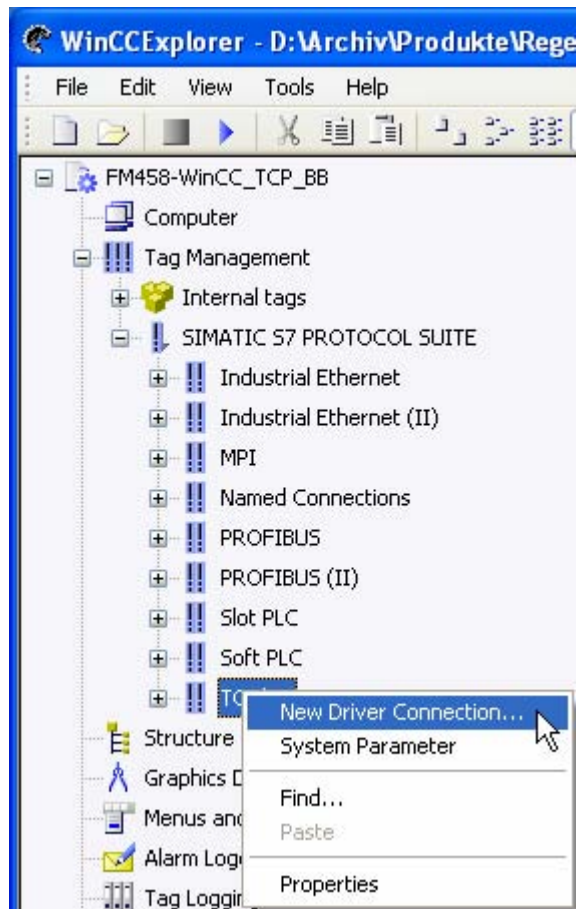

- To do this, assign a name to the connection in the dialog box, press the properties button and enter the parameter for the connection (TCPI/IP address and slot can be taken from HW Config; refer to the following screenshot).

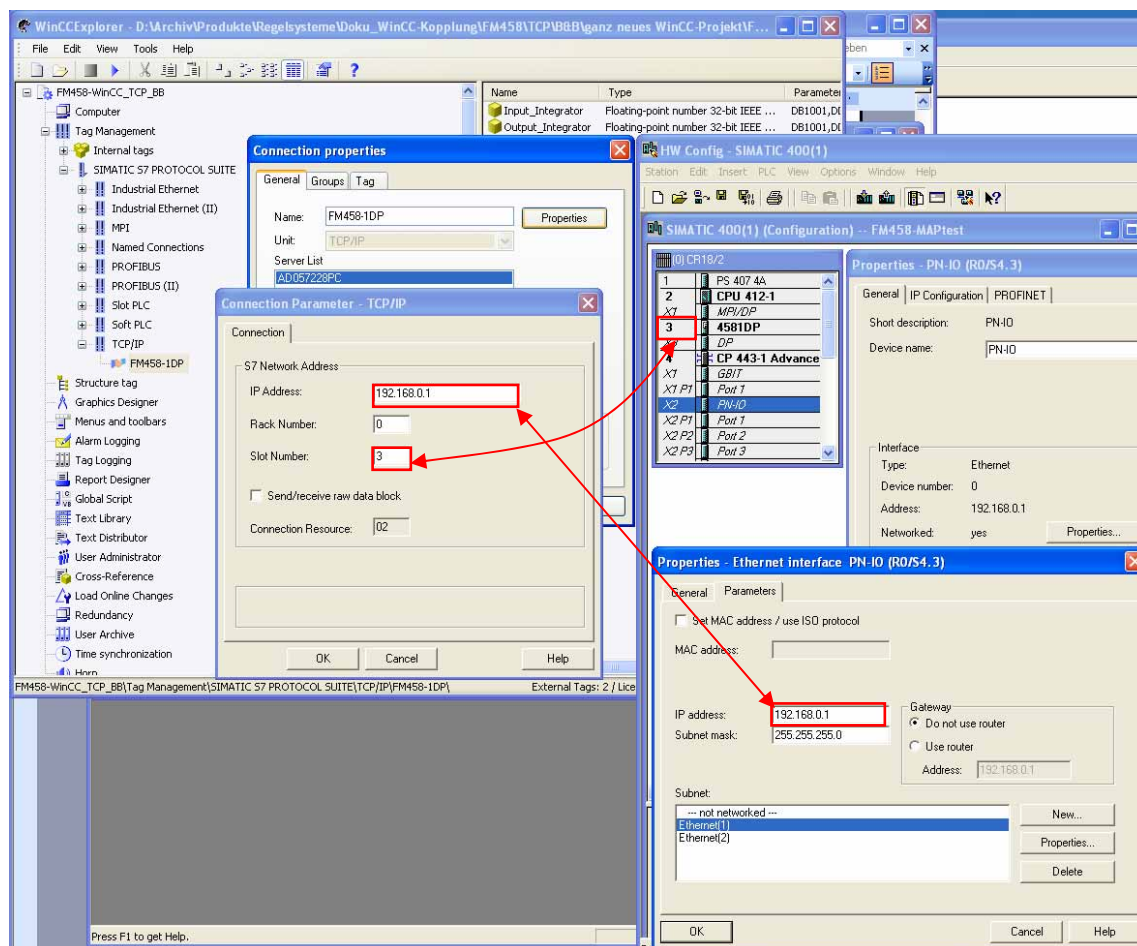

A new TCP/IP connection is created after the dialog box is exited with OK.

6. **Setting-up tags:** Select the connection that has just been set-up using the righthand mouse key and select "New Tag" in the menu that is displayed.

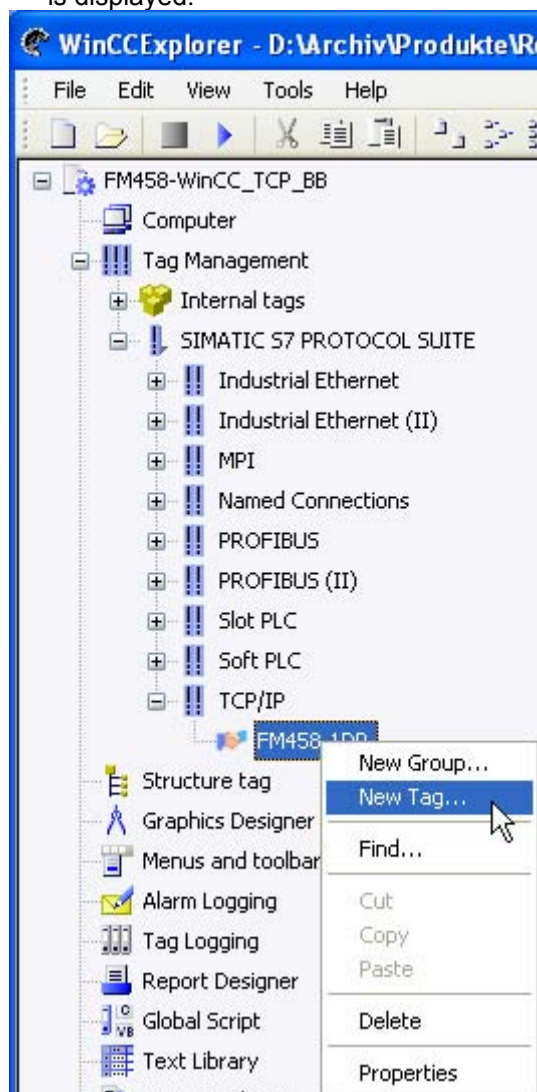

7. In the dialog box that opens, enter a variable name (e.g. function block name_connection name, however, any other name can also be specified).
 The data type of the selected connector, taken from the CFC configuring or - for the CFC compilation - from the address book created, can be set under "Data Type" (a reference table of the various data types can be found later on).
 The address dialog box is opened by pressing the "Select" button. The DB number and the offset are specified in this address dialog box. Take this data for the particular connection from the address book created when the CFC was compiled (refer to the next screenshot).

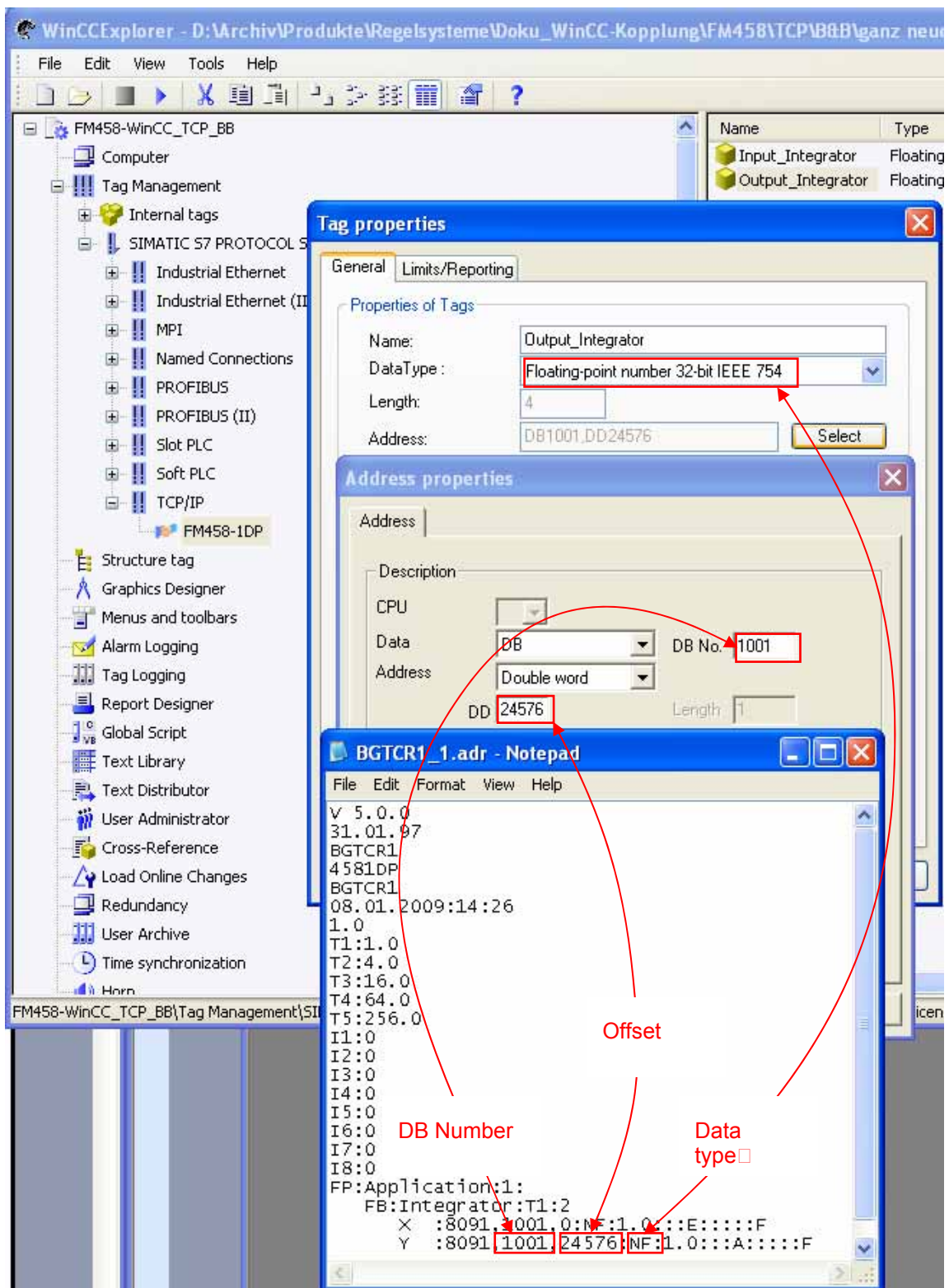

STRUC V.4.x data type	D7-SYS data type	Designation
B1	BO	Bool
I2 / N2 / O4	I	Integer
I4 / N4 / O4	DI	Double-Integer
NF	R	Real
V1	BY	Byte
V2	W	Word
V4	DW	Double-Word
NS	S	String
TF	TS	SDTime
IK, NK, CR, MR, TR, RR	GV	Global

8. After entering the appropriate data and exiting the dialog boxes with OK, a variable is set-up in WinCC for the selected block connection.
9. For additional block connections required, the procedure from step 6 onwards should be repeated.
10. In the input window "System Parameter" the driver (TCP / MPI → righthand mouse key → System Parameter) the checkmark for "Cycle management" must **not** be set (refer to the next screenshot).

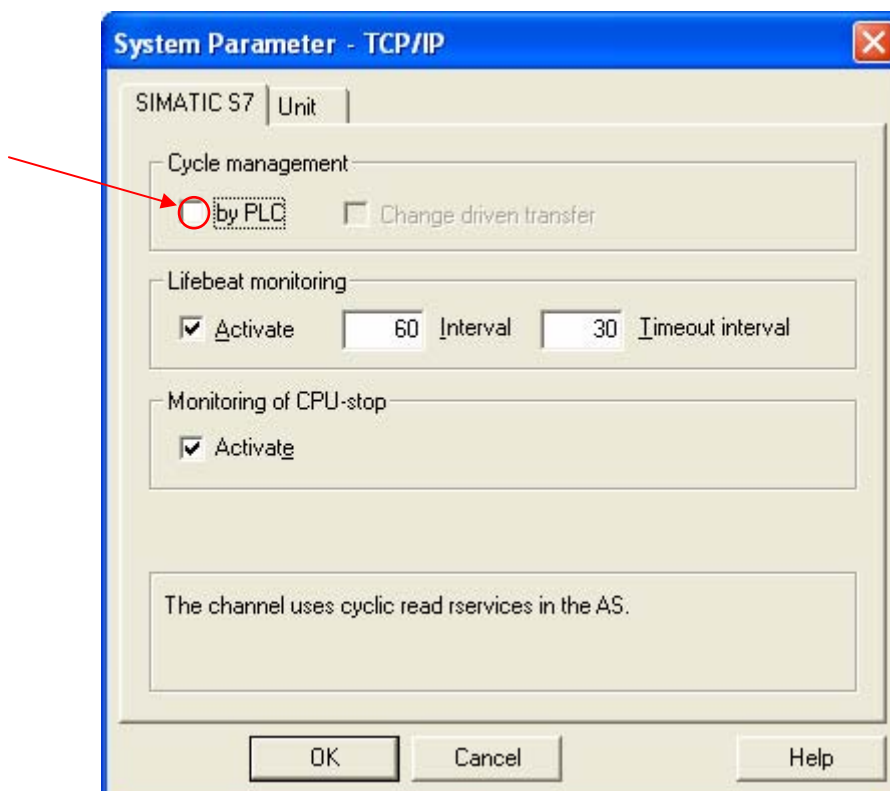

11. The variables thus set-up can now be referenced in the screen configurations in order to be accessed from WinCC in the runtime mode.

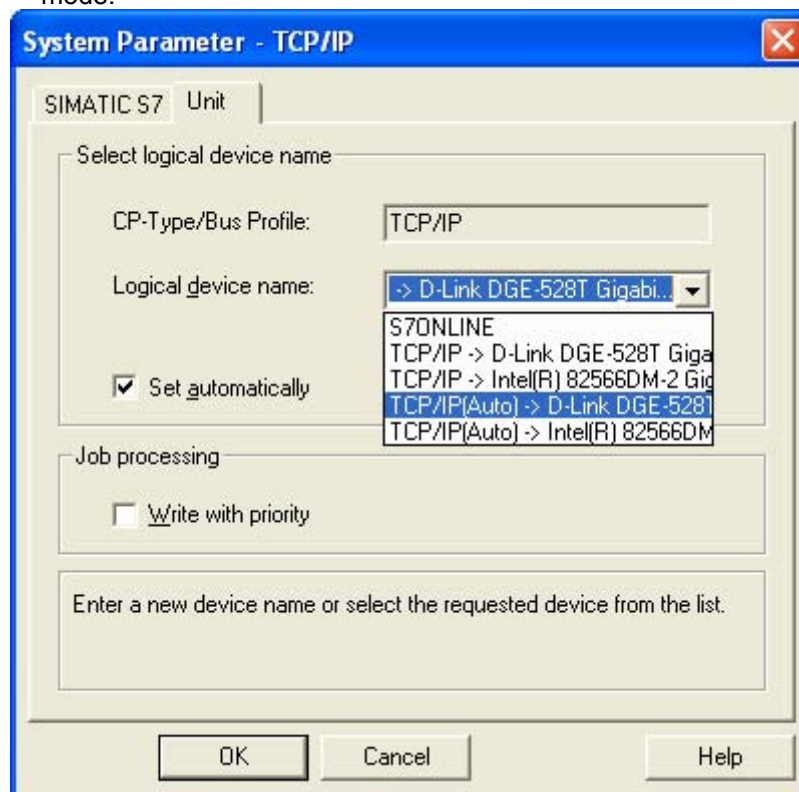

12. Now, a reference can be made in the screen configuring to the tags that have been set-up in this way.

4.9.2 "S7DB" configuration version

When using the "S7DB_P" function block, the connection markings in the CFC charts and the creation of the address book are not required.

Instead of this, the "S7DB_P" function block should be configured with the appropriate pointer-based communication blocks. The block connections, which must be accessed from WinCC, must be connected-up to the S7DB_P function block using "pointer-based communication blocks". Function block S7DB_P sets-up a data block for this data. Please proceed in the following steps:

1. Configure function block S7DB_P. With a righthand mouse click in connector "XDB", select "Interconnection to operands" and specify the required DB number.
2. Connect each connector to be visualized (e.g. as in the next diagram: Connectors "X" and "Y" of the "Integrator" function block) to a dedicated, pointer-based communication block from the "pointer com" family of function blocks corresponding to the particular connector type (e.g.: "DRD" function block for read real variables).
3. Connect connector "PTR" of the S7DB_P to the "PTR" connectors of all pointer-based communication blocks.
4. Take the data block number (e.g.: DB1) from the sheet bar and the offset from the pointer-based communication block connectors (OF1 + OF2) of the CFC configuring, open the address dialog box by pressing the "Select" button, and then specify the DB number and the offset in this address dialog box (refer to the next screenshot). Then close the input window with OK.

The screenshot illustrates the configuration of a tag in WinCC Explorer. The **Tag properties** dialog is configured with the following settings:

- Name: Input_Integrator
- Data Type: Floating-point number 32-bit IEEE 754
- Length: 4
- Address: DB1.DD0
- Adapt format: FloatToFloat

The **Address properties** dialog is configured with the following settings:

- Data: DB
- DB No.: 1
- Address: Double word
- DD: 0

The main interface shows a ladder logic diagram with a **DWR** (Write REAL) block. The data table below shows the configuration for the tag:

DB Number	Offset	Data
1	0	1000.0
1	4	0.0
1	8	0.0
1	12	1ms

All of the other configuring steps do not differ from the procedure when using OCM functions.

4.9.3 MPI and PROFIBUS DP coupling versions

The deviations relating to either an MPI or DP coupling – that must be taken into account – are described in the following chapter.

4.9.3.1 Hardware configuration

If the central MPI interface of the CPU is used, no hardware changes are required. If the FM458-1 DP is to be coupled via the DP interface, then the PROFIBUS DP line should be configured at the DP interface as shown in the following.

1. Double click on the X3 interface of the FM458 1DP.
2. Click on "Properties" under the "General" tab.

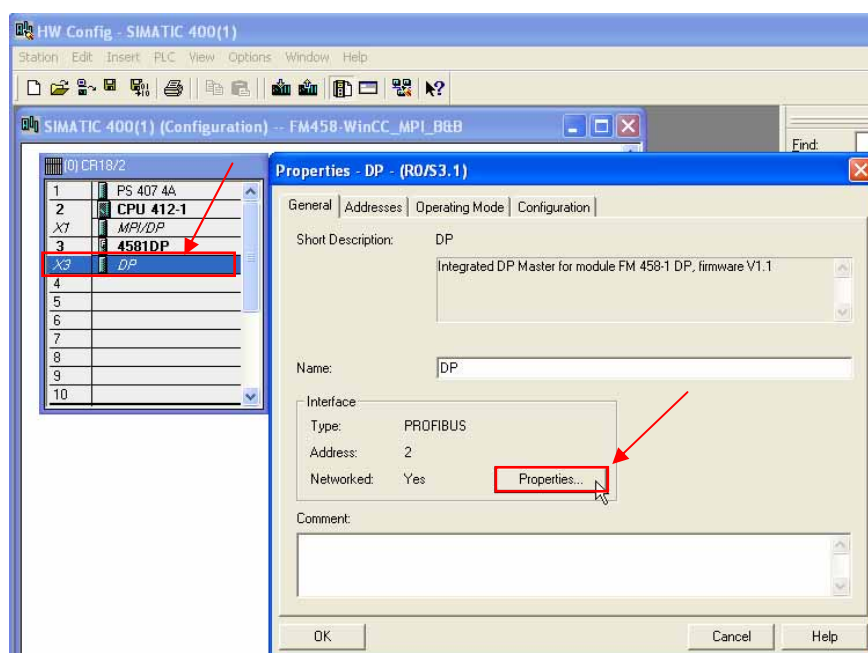

3. In the next window, insert a new "Subnet" by clicking on "New".

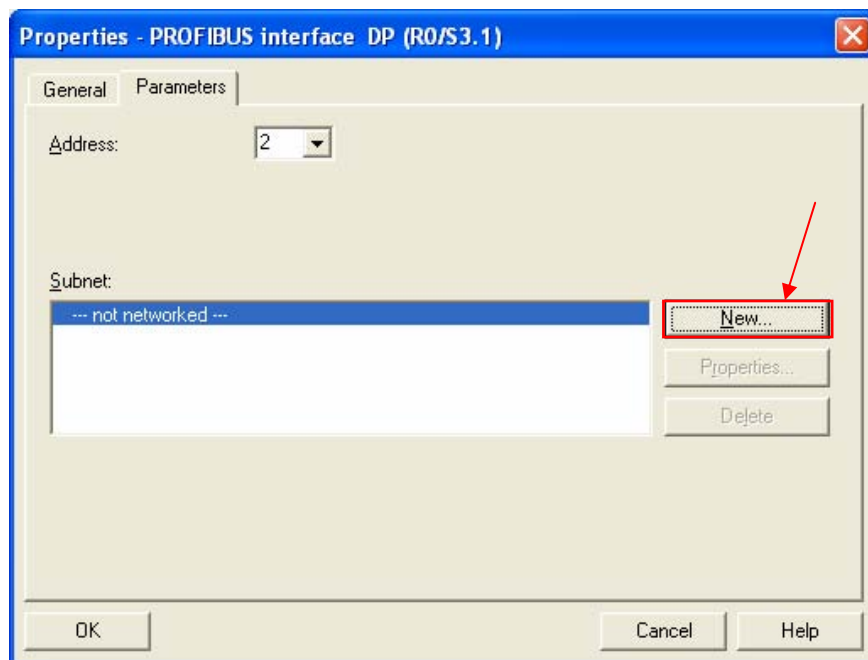

4. If required, change the name and open the "Network Settings" tab.

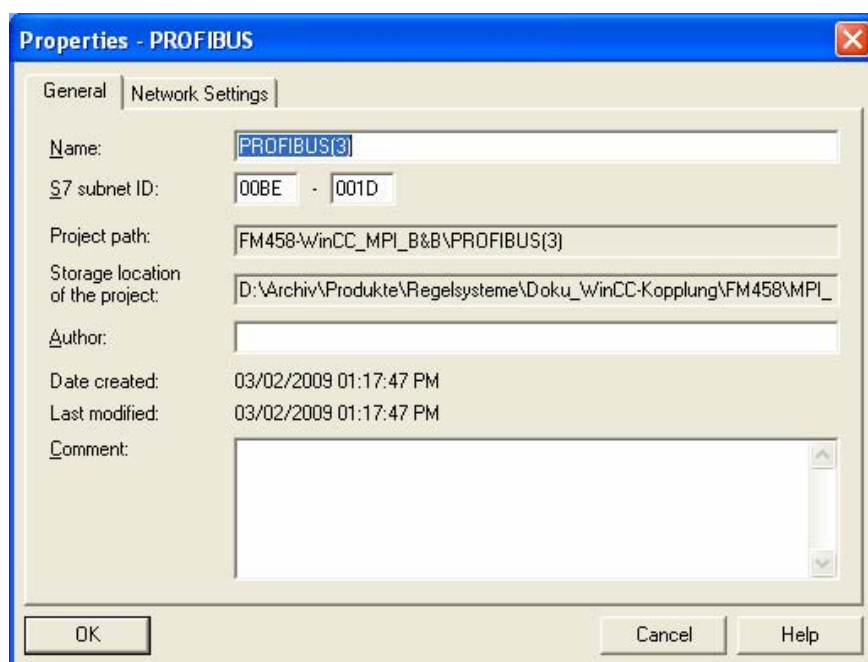

5. Select the required baud rate in the next window.

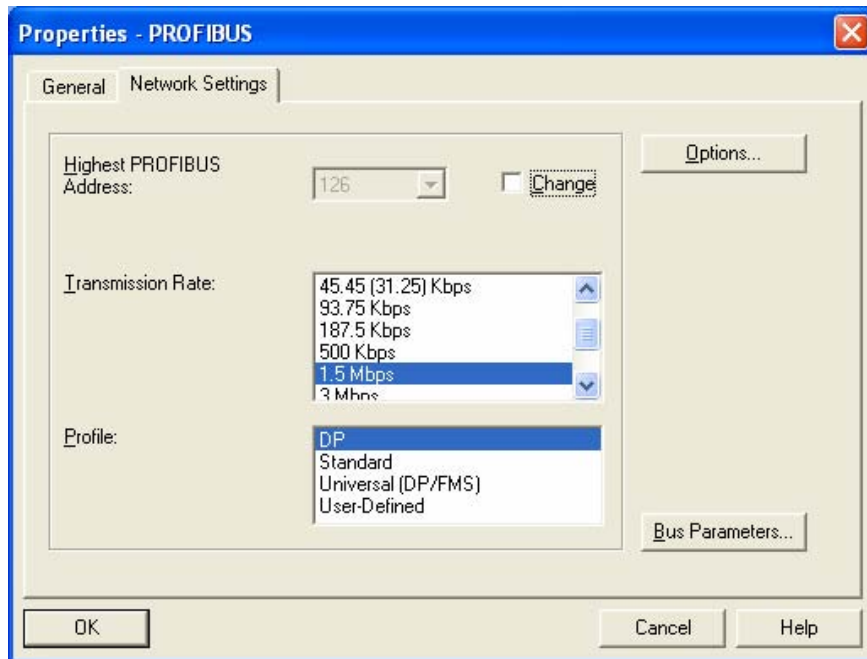

6. Close this window and set the address in the next window. Then close all of the other windows with "OK".

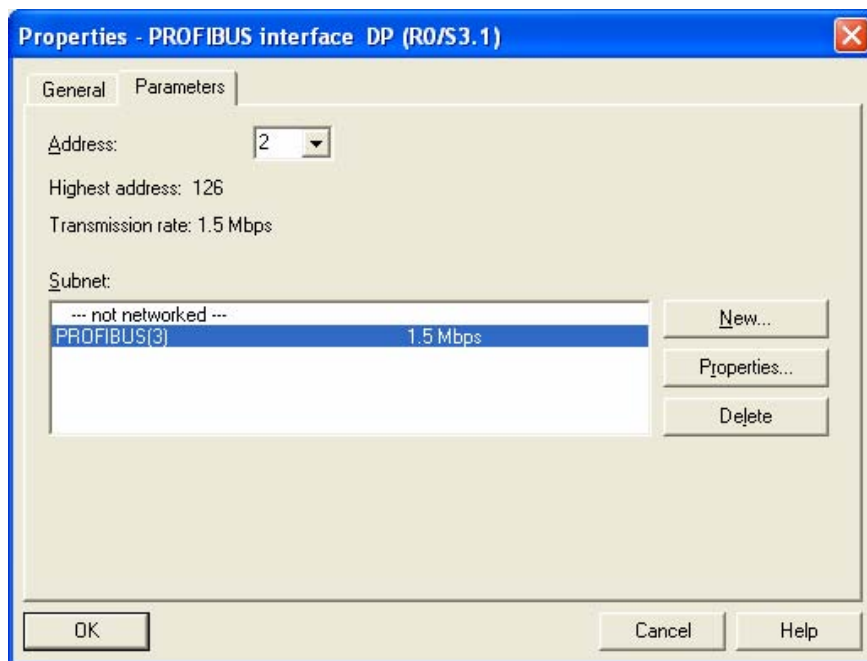

- This means that the PROFIBUS DP line is configured as shown in the next screenshot.

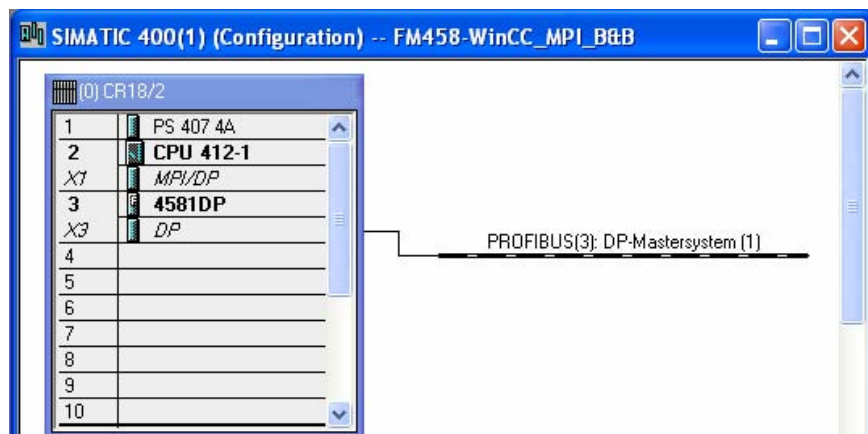

4.9.3.2 Configuring the CFC

No additional function blocks have to be configured when using the MPI coupling.

If the DP interface of the FM458-1 DP is to be used, then as shown in the following screenshot, function block "@PRODP" should be configured in a task between 32 and 256 ms.

Connector CTS should be connected to interface X3 of the FM458-1 DP (righthand mouse click on the CTS > Connection to operands > NAME of the FM458-1 DP.X3).

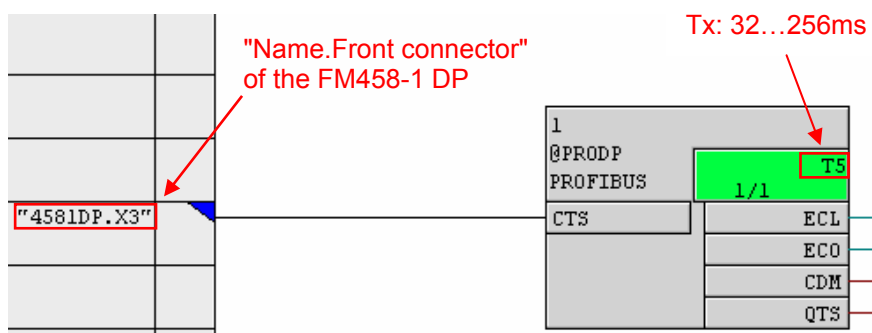

4.9.3.3 Configuring WinCC

1. Set up the new driver by selecting **Tag Management** → **righthand mouse key** → **Add New Driver** → **SIMATIC S7 Protocol Suite.CHN** → **Open**.
If this already exists, then continue with the next step.
2. Set-up a new connection by selecting **MPI** → **righthand mouse key** → **New Driver Connection**.

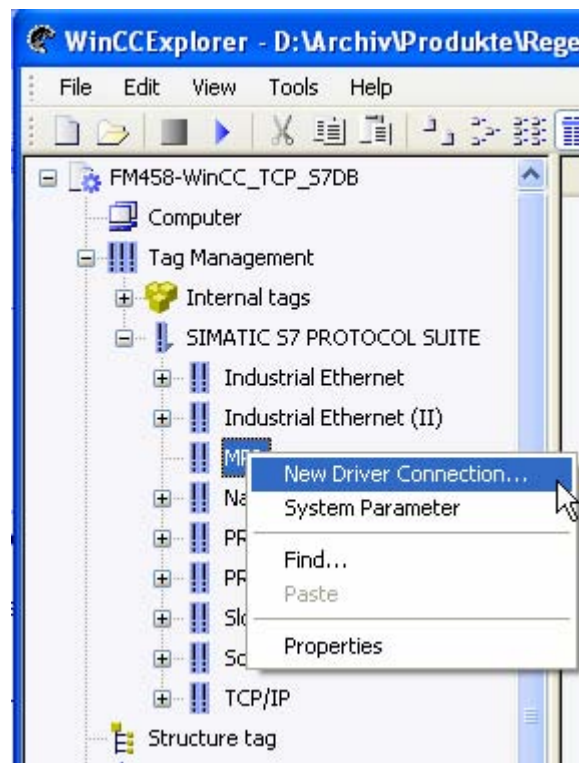

3. Assign a name in the dialog box, press the Properties button and enter the parameters for the connection.
4. In the WinCC input screen "Connection Parameter" the station address and the slot number - as shown in the following diagram - should be taken from the HW configuration.

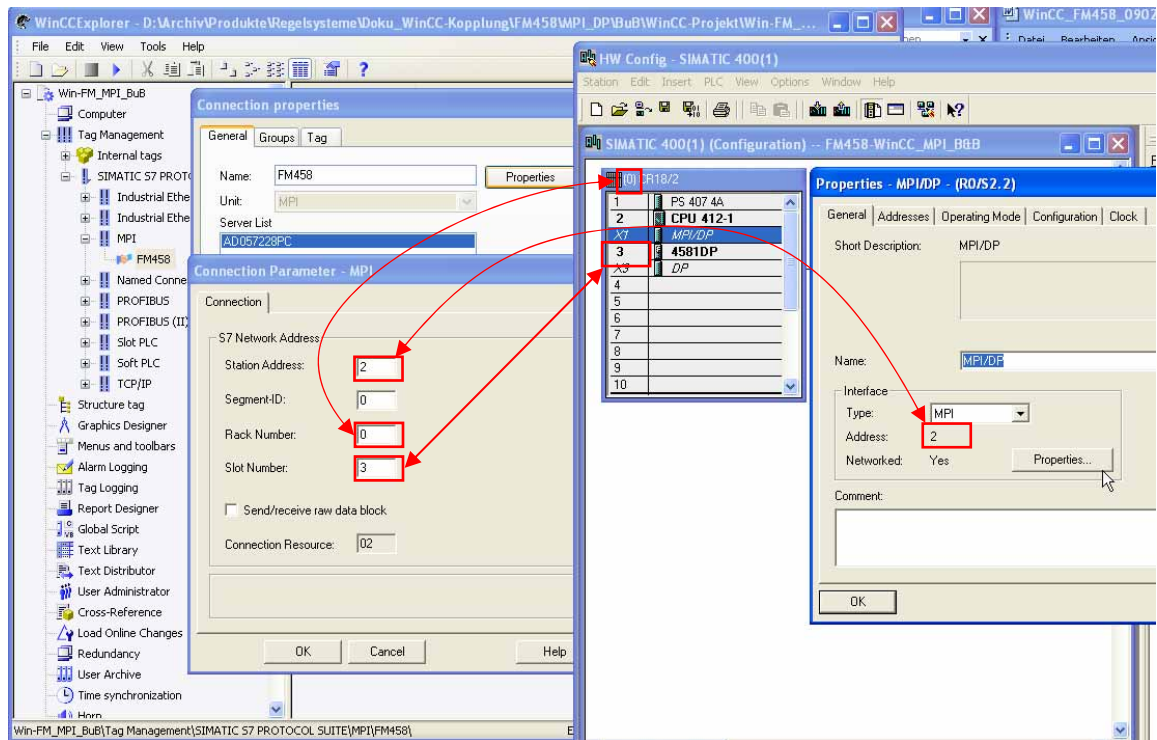

The remaining configuring steps do not differ from those associated with a TCP/IP coupling, and should therefore be taken from the previous chapter.

4.9.4 Configuring using the D7-SYS-OS engineering tool "Mapper"

The "D7-SYS engineering tool" - also called "Mapper" in the following text - sets-up tags for the selected connectors of the CFC function blocks. These tags can then be further processed by WinCC. The following chapter describes how to use this tool.

Calling the mapper:

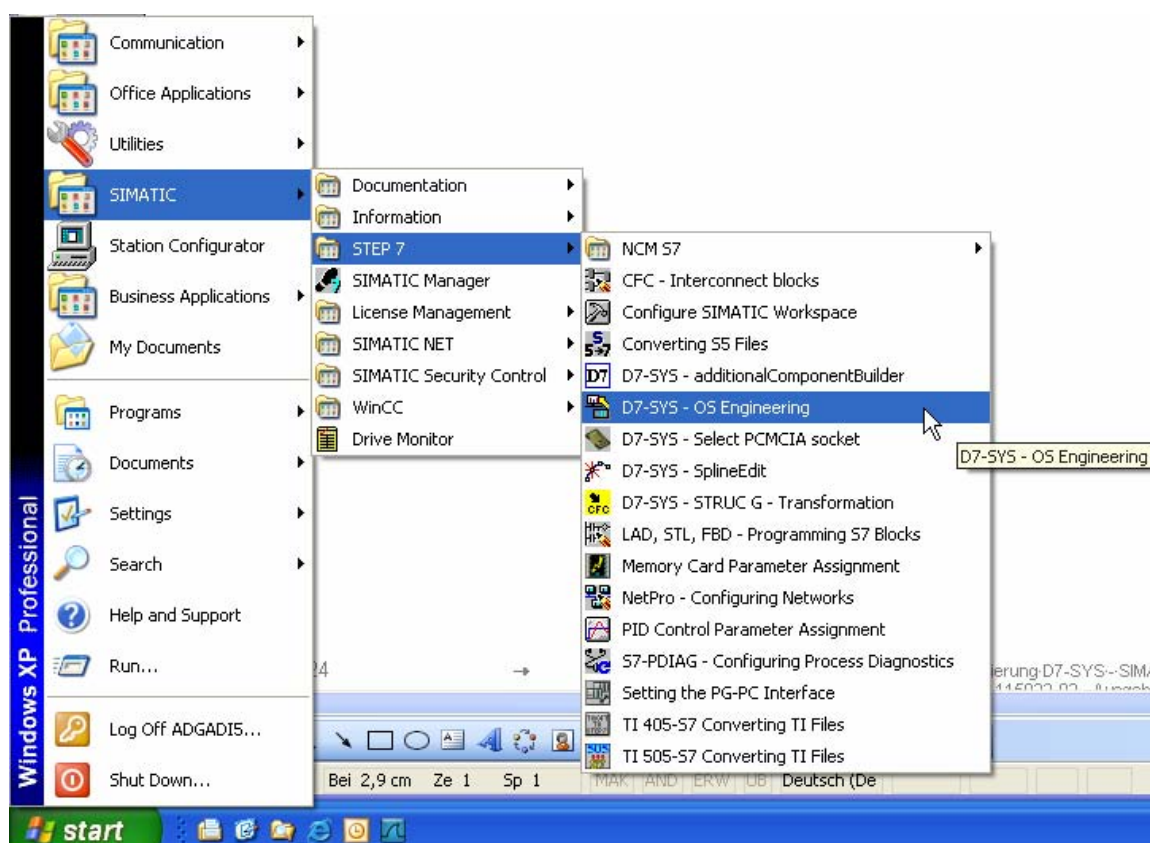

Prerequisites for mapping operation:

- Select the CFC function block connectors and then compile with the "Create address book" option activated, as described in the previous chapter.
- Inserted PC station with communication module and WinCC application.
- The "NetPro" configuration should be checked as to whether all stations are connected with one another via the required coupling types; for example, in this case, via TCP/IP. The same procedure should be used for MPI or DP couplings.

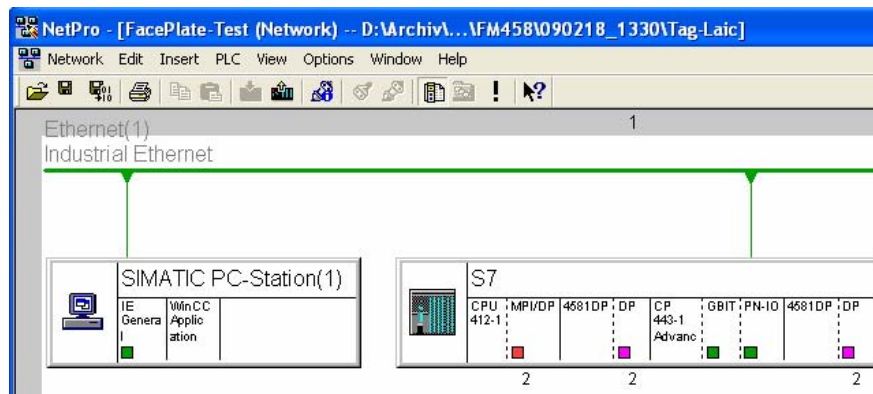

After the call, the target project should be selected using the lefthand "Open" icon:



A Wizard is started by clicking twice on the 2nd icon (Wizard's hat):

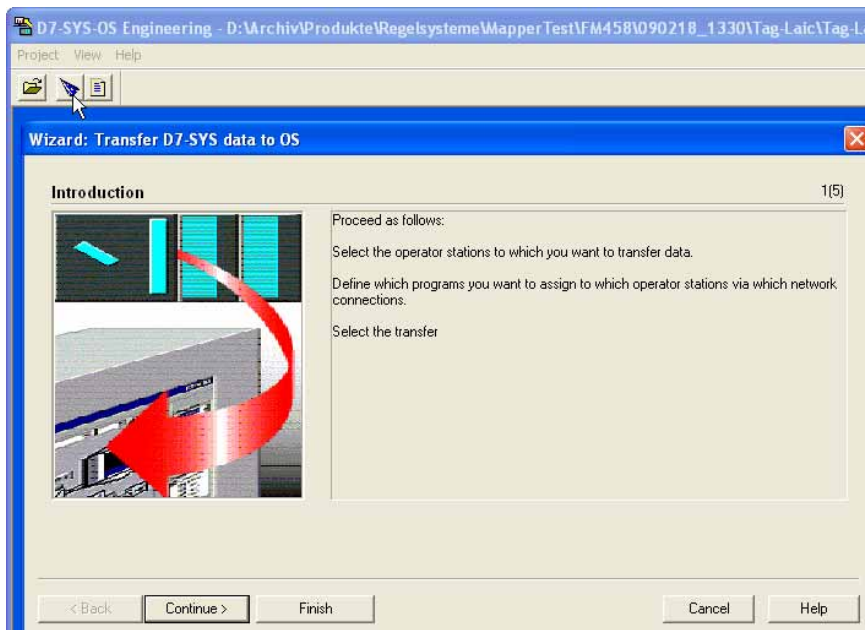

Then click on "Continue":

The operator station is then selected as shown in the next screenshot:

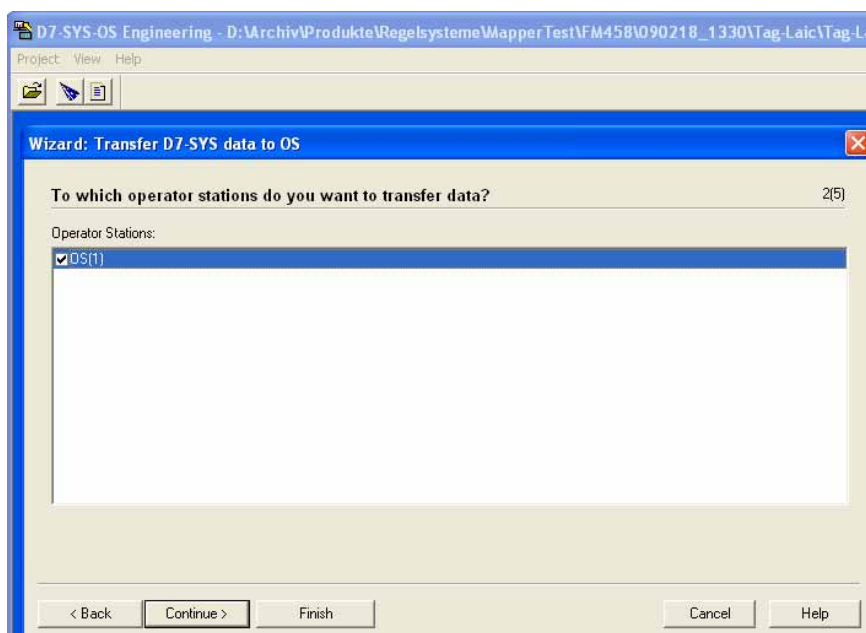

Then click on "Continue":

The selection and assignment of the programs to the operator stations is then realized in the next step:

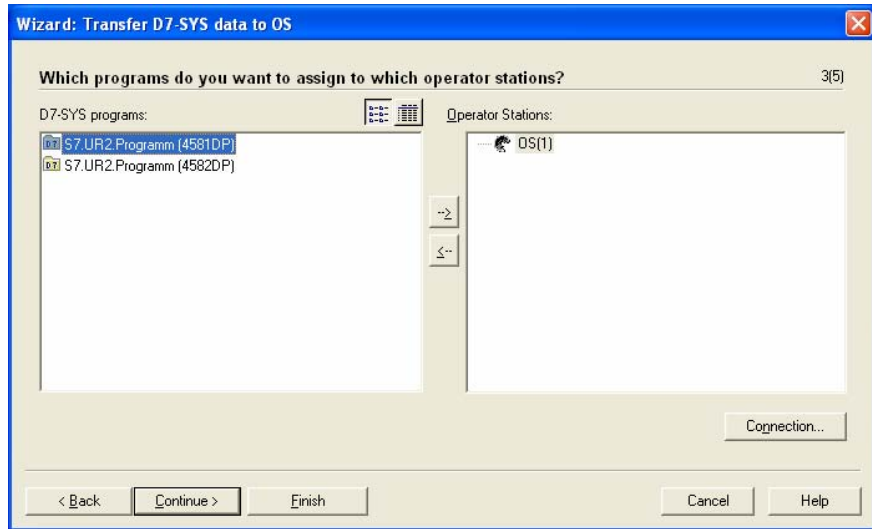

Displaying the selected programs:

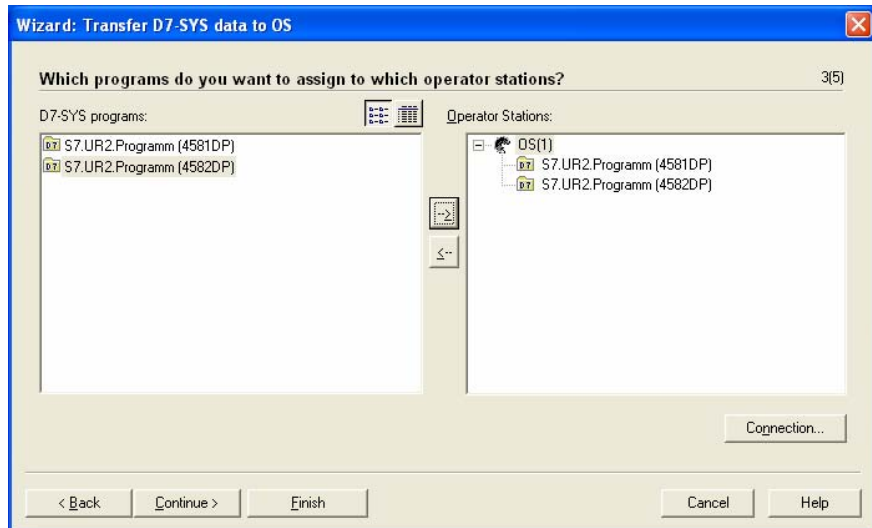

If the connection parameters are to be checked, then click on "Connection". This is not absolutely necessary if "NetPro" has been correctly configured. However, if various couplings are used (TCP/IP, MPI or DP) then the required connection should be selected.

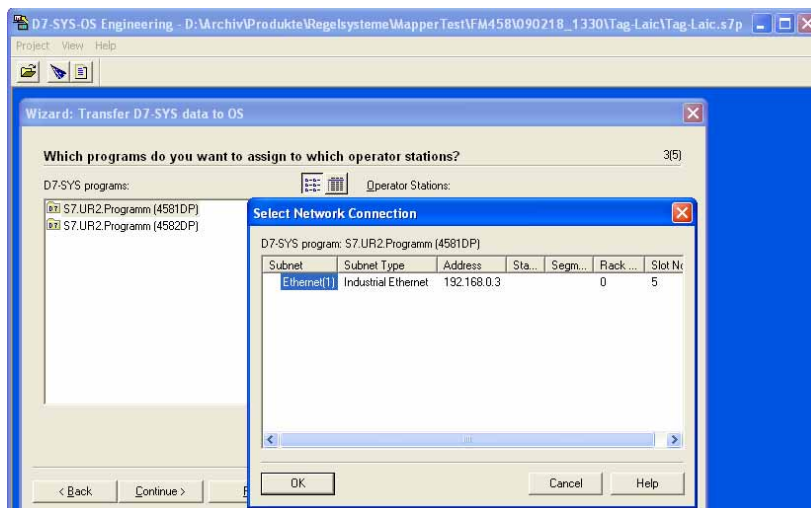

Then click on "Continue":

For smaller projects, "All" can be transferred each time. However, for larger projects, this would involve significant delays and it is recommended that "Changes Only" are mapped (transferred).

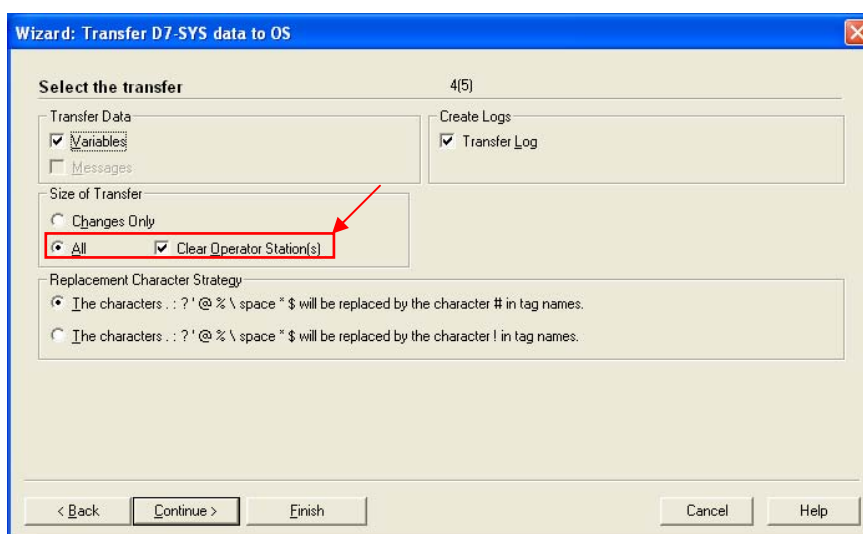

Then click on "Continue":

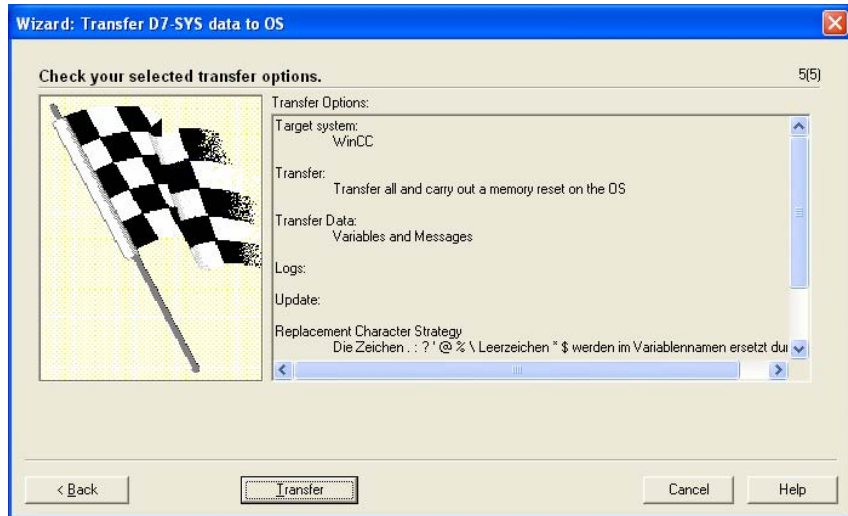

Then, start the actual mapping (transfer) process by clicking on "Transfer".

Transferring (mapping) then runs:

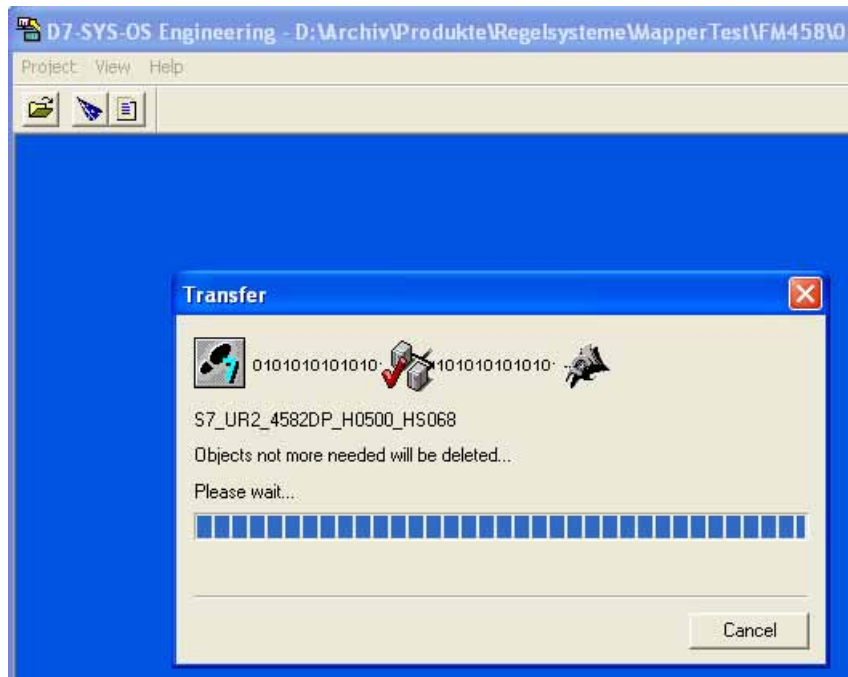

This therefore completes data transfer:



End by clicking on "OK"

The tags that have been created are listed in WinCC Explorer:

Name	Type	Parameters	Last Change
ReglerA_1.Input	Floating-point number 32-bit ...	DB1001,DD0	2/12/2009 12:35:26 PM
ReglerA_1.Output	Floating-point number 32-bit ...	DB1001,DD24576	2/12/2009 12:36:01 PM
S7_Rack01_FM4581_Ap_Inte...	Floating-point number 32-bit ...	DB1001,DD0	2/18/2009 1:25:33 PM
S7_Rack01_FM4581_Ap_Inte...	Floating-point number 32-bit ...	DB1001,DD4	2/18/2009 1:25:33 PM
S7_Rack01_FM4581_Ap_Inte...	Floating-point number 32-bit ...	DB1001,DD8	2/18/2009 1:25:33 PM
S7_Rack01_FM4581_Ap_Inte...	Floating-point number 32-bit ...	DB1001,DD12	2/18/2009 1:25:33 PM
S7_Rack01_FM4581_Ap_Inte...	Floating-point number 32-bit ...	DB1001,DD16	2/18/2009 1:25:33 PM
S7_Rack01_FM4581_Ap_Inte...	Unsigned 8-bit value	DB1001,DBB20	2/18/2009 1:25:33 PM
S7_Rack01_FM4581_Ap_Inte...	Floating-point number 32-bit ...	DB1001,DD24576	2/18/2009 1:25:33 PM
S7_Rack01_FM4581_Ap_Inte...	Unsigned 8-bit value	DB1001,DBB24580	2/18/2009 1:25:33 PM
S7_Rack01_FM4581_Ap_Inte...	Unsigned 8-bit value	DB1001,DBB24581	2/18/2009 1:25:33 PM

The system parameters of the coupling, shown in the following diagrams, now have to be checked:

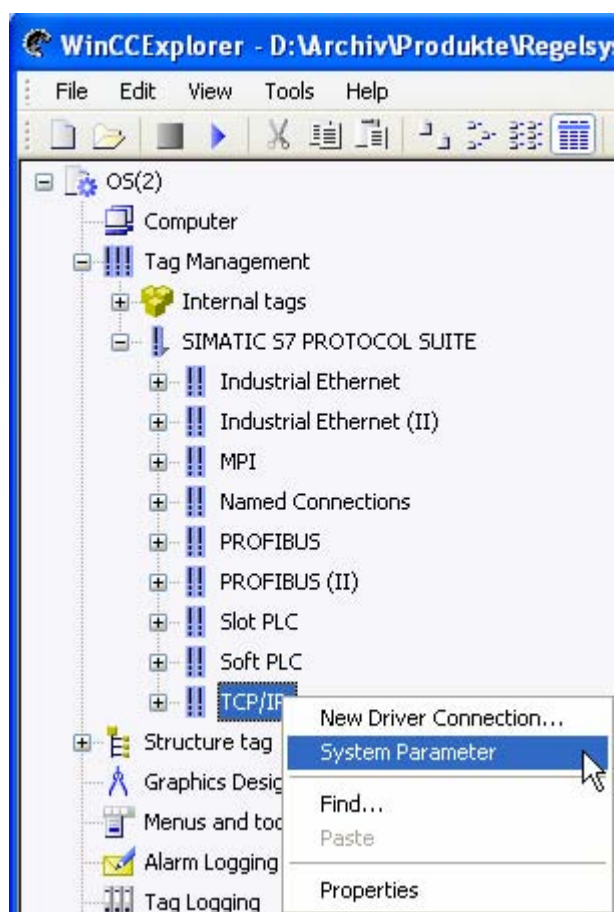

Deactivate cycle management by the automation system:

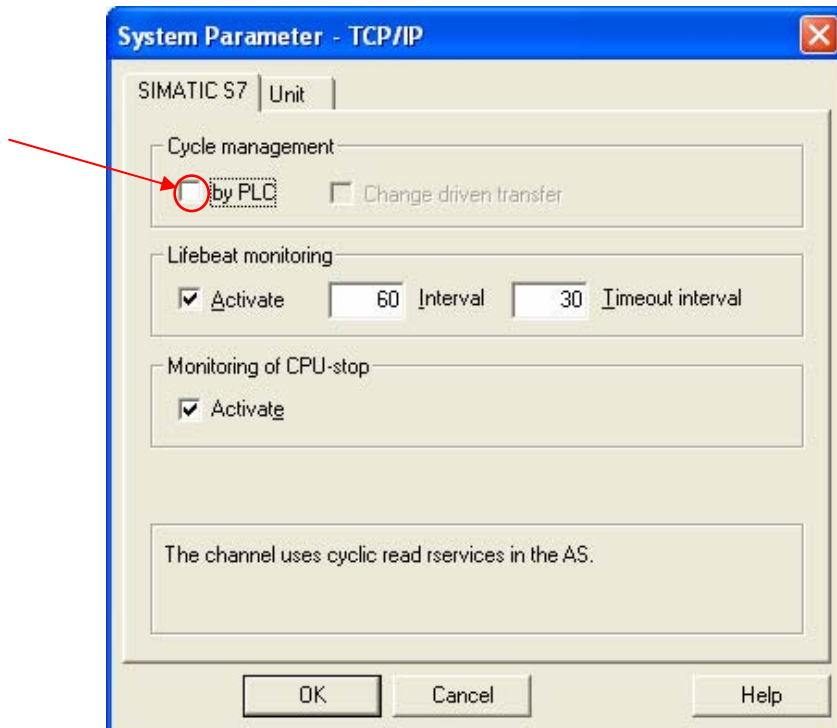

Select the device name:

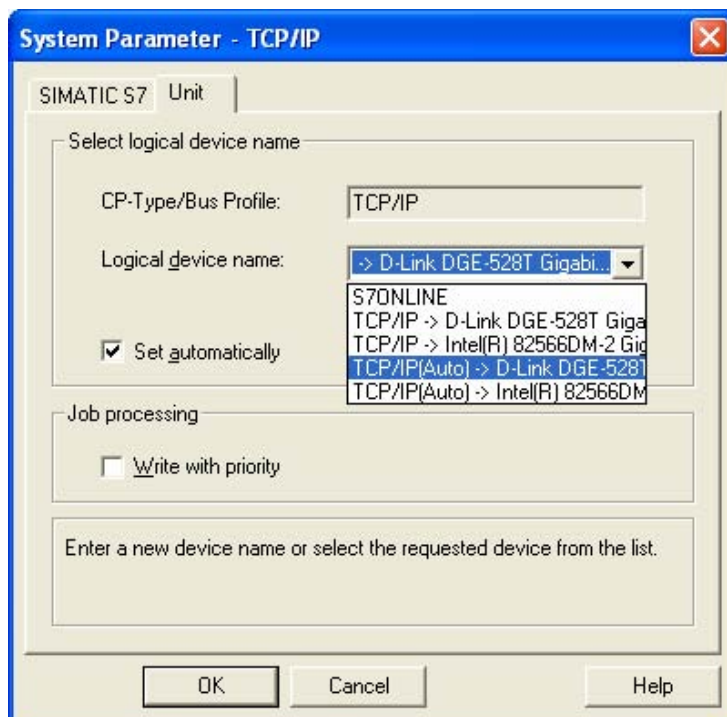

After changing the system parameters WinCC has to be restarted. It will be possible to access the configured variables once this has been completed.

5 Assembly guidelines

5.1 Installation and EMC guidelines

NOTE

The information in this Manual does not purport to cover all details or variations in equipment, nor to provide for every possible contingency to be met in connection with installation, operation or maintenance.

Should further information be desired or should particular problems arise which are not covered sufficiently for the purchaser's purposes, please contact your local Siemens office.

Further, the contents of this Manual shall not become a part of or modify any prior or existing agreement, commitment or relationship. The sales contract contains the entire obligation of Siemens. The warranty contained in the contract between the parties is the sole warranty of Siemens. Any statements contained herein do not create new warranties nor modify the existing warranty.

5.1.1 Definitions

5.1.1.1 Qualified personnel

For the purpose of this Manual and product labels, a „Qualified person“ is someone who is familiar with the installation, mounting, start-up and operation of the equipment and the hazards involved. He or she must have the following qualifications, for example:

1. Trained and authorized to energize, de-energize, clear, ground and tag circuits and equipment in accordance with established safety procedures.
2. Trained in the proper care and use of protective equipment in accordance with established safety procedures.
3. Trained in rendering first aid

5.1.1.2 Danger and warning information



DANGER

For the purpose of this Manual and product labels, „Danger“ indicates death, severe personal injury and/or substantial property damage will result if proper precautions are not taken.



WARNING

For the purpose of this Manual and product labels, „Warning“ indicates death, severe personal injury or property damage can result if proper precautions are not taken.



CAUTION

For the purpose of this Manual and product labels, „Caution“ indicates that minor personal injury or material damage can result if proper precautions are not taken.

NOTE

For the purpose of this Manual, "Note" indicates information about the product or the respective part of the Instruction Manual which is essential to highlight.



CAUTION

This board contains components which can be destroyed by electrostatic discharge. Prior to touching any electronics board, your body must be electrically discharged. This can be simply done by touching a conductive, grounded object immediately beforehand (e.g. bare metal cabinet components, socket protective conductor contact).



WARNING

Hazardous voltages are present in this electrical equipment during operation.

Non-observance of the safety instructions can result in severe personal injury or property damage.

It is especially important that the warning information in all of the relevant Operating Instructions/Instruction Manuals is strictly observed.

5.1.2 Introduction

What is EMC?

Electromagnetic compatibility (EMC) is the ability of an electrical device to function, fault-free in a specified electromagnetic environment without influencing the environment in an inadmissible fashion.

This design- and EMC guideline supplements the documentation on the individual components.

The FM 458-1 DP control system consists of individual components (e. g. subracks, modules, interface modules, operator control panels, position transmitters). The components can be installed in the widest range of system configurations according to individual requirements. When the components are arranged in a distributed fashion (decentral topology) a noisy environment cannot be neglected. Thus, specific requirements are placed on the design and EMC of the system.

EMC represents a quality feature for

- **Intrinsic noise immunity:** Immunity against internal electrical noise and disturbances
- **External noise immunity:** Immunity against external electromagnetic noise
- **Noise emission level:** Influencing the environment due to electromagnetic radiation

Operational reliability and noise immunity

In order to achieve the highest possible operational reliability and safety and noise immunity for a complete system (closed-loop control and drive motor) the control manufacturer and user (including end customers) must take certain measures.

Perfect functioning of FM 458-1 DP can only be guaranteed and the legal requirements fulfilled (EC Directive **2004/108/EC** „EMC guideline“) if all of these measures are observed.

5.1.3 Standards and certifications

NOTE You find detailed information to the standards and certifications in the reference manual "SIMATIC S7-400 Automation System Module Data, chapter 1, section: Standards, certificates and approvals".

5.1.3.1 FM 458-1 DP outputs



DANGER When the equipment is powered-up or powered -on, the outputs have undefined statuses while the power supply voltages are running-up. This fact must be taken into account when designing the system.

5.1.3.2 Professionally-trained and knowledgeable personnel

Only professionally-trained, knowledgeable personnel may configure, install, commission and operate FM 458-1 DP.

5.1.3.3 Connecting external voltages

If external voltages (e. g. pulse encoders) are connected to FM 458-1 DP inputs, which are supplied from an external power supply, then this external supply must also be shutdown when the FM 458-1 DP power supply is shutdown or fails.

5.1.4 Mounting and operation

The subracks for the S7-400 are designed for wall mounting, mounting on frames and for installation in racks and cabinets. The retaining dimensions are in conformance with DIN 41 494.

In the validity area of UL/CSA and the EC Directive 2006/95/EC (Low Voltage Directive), it is necessary to install the subrack in a cabinet, an enclosure or an enclosed operating room so that the regulations for electrical safety are fulfilled (refer to the SIMATIC S7-400 Automation System/M7-400 Module Data Reference Manual, Chapter 1).

The subrack must be installed so that the ventilation slots of the module point up and down.

All of the modules must be inserted in the subrack left-justified in order to obtain the optimum EMC-compliant design. It is not permissible that there are gaps between the individual modules.

The terminal blocks must be inserted so that the ventilation slots point up and down.

5.1.5 Subrack

- The subrack must be connected to the ground/potential bonding rail through the shortest possible connection using a cable with min. 10mm².
- All of the modules must be tightly screwed into the subrack. This is also true during the commissioning phase!
- If modules are inserted in adapters during the commissioning phase, the front panel must be connected to the housing using the shortest possible connection.
- Modules may neither be withdrawn nor inserted under voltage.
- The connectors for serial interfaces must be tightly screwed to the front panel.

5.1.6 Cables

All signal cables, which are connected to FM components, must be shielded.

The shield braiding of incoming and outgoing signal cables must be connected as close as possible at the terminal block or at the FM components on the shield rail.

The shield braiding of cables between the terminal blocks and the FM components must be connected to the shield rail at both ends.

Cables entering from outside (e.g. cables to the terminal modules) may not be routed together with internal cables in a cable duct.

Serial connecting cables must be shielded. The shield must be connected to a metallic connector housing. In addition, it must also be connected to the shield rail. The cable shield may not be connected to pin 1 of the connector.

A shield using the front panel of the modules is not effective.

Analog signal cables must be shielded, both inside and outside the cabinet.

Shielding, permissible cable lengths

All signal cables must have a cable shield.

Module	Cable length, shielded
Outputs	1000 m
Inputs, 230 V AC	1000 m
Inputs, 24...60 VDC	1000 m

A minimum clearance of > 10 cm must be maintained between signal cables and power cables below 500 V AC; a clearance > 30 cm must be maintained between signal cables and power cables above 1 kV AC.

The following should be carefully observed when mounting/installing in a cabinet:

For incoming shielded cables (analog and binary signals), the shield must be connected to the shield rail where the cable enters the cabinet. The cable must then still be shielded up to the terminal module/board. Shields are not connected to the terminal modules/boards.

For additional information refer to the following documentation "S7-400 and M7-400 Programmable Controllers Hardware and Installation", Installation Manual (Order No. C79000-G7000-C14).

5.1.7 Potential bonding

In order to ensure disturbance-free operation, the components which are connected and communicate with one another may not be at different potentials. This means that all components must be connected with one another through potential bonding cables.

For additional information refer to Installation Manual "S7-400 and M7-400 Programmable Controllers Hardware and Installation".

5.1.8 Principle when connecting components

All of the components (subracks, power supplies etc.), which are connected using signal cables, must also be connected with potential bonding cables (exception: Components with fiber-optic cable connections).

For additional information refer to Installation Manual „S7-400 and M7-400 Programmable Controllers Hardware and Installation“.

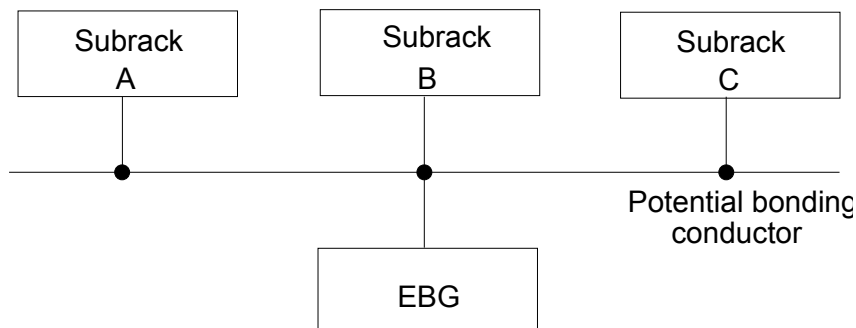

5.1.9 Potential bonding rail

There should be a potential bonding and grounding rail below the subrack.

All of the internal and external components must be connected to this potential bonding- and grounding rail.

The shields of all cables must be connected to this grounding rail.

For additional information refer to Installation Manual „S7-400 and M7-400 Programmable Controllers Hardware and Installation“.

Basic circuit

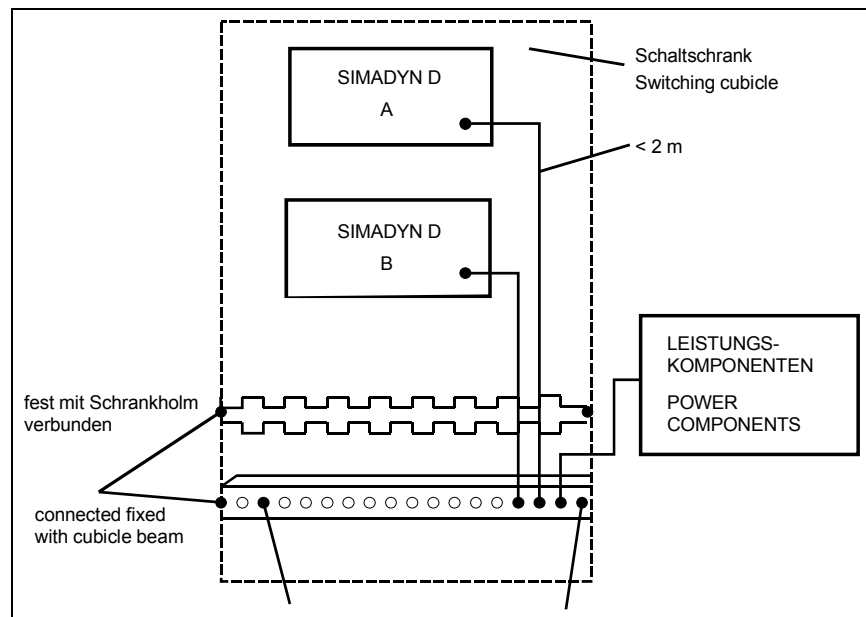

5.1.10 Protective grounding

The protective ground is connected via the protective conductor (PE) at the cabinets and components. For S7-400, the potential bonding conductor/cable does not have a protective conductor function. For S7-400, it is required for reliable operation and noise suppression.

The protective conductor must be routed in accordance with DIN VDE 0100 and DIN VDE 0160.

For subracks, the protective conductor cross-section must be $\geq 10 \text{ mm}^2$.

For additional information refer to Installation Manual „S7-400 and M7-400 Programmable Controllers Hardware and Installation“.

5.1.11 Cabinet

- If the S7-400 components are installed in an electrical cabinet, then this must be implemented as follows:
- Each cabinet must have a ground/potential bonding rail, which is connected to the cabinet frame at both ends.
- All S7-400 subracks must be connected to the grounding/potential bonding rail through a 10 mm^2 cable which should be as short as possible. The connection via the PE connection of the power supply is not sufficient.

- Non-damped contactors may not be used in a cabinet with FM components.
- If non-damped contactors are used in a cabinet then adjacent cabinets must be separated by a metal partition.
- Each cabinet in which S7-400 components are installed/mounted must have a screen rail. Serrated rails are suitable. The screen rail must be connected directly to the cabinet frame.
- No gas discharge lamps may be used in the cabinet.
- The screens of incoming cables must be connected directly to the screen rail.
- The cabinets must be designed so that air can circulate freely within them.

For additional information refer to Installation Manual „S7-400 and M7-400 Programmable Controllers Hardware and Installation“.

5.1.12 Mounting clearances

For additional information refer to Installation Manual „S7-400 and M7-400 Programmable Controllers Hardware and Installation“.

5.1.13 Ground connection for configurations which are not isolated

For additional information refer to Installation Manual „S7-400 and M7-400 Programmable Controllers Hardware and Installation“.

5.1.14 Air guidance

For additional information refer to Installation Manual „S7-400 and M7-400 Programmable Controllers Hardware and Installation“.

5.1.15 Power loss in the cabinet

For additional information refer to Installation Manual „S7-400 and M7-400 Programmable Controllers Hardware and Installation“.

5.1.16 Power supply

In order to diminish the effects of noise and disturbances, a line filter should be provided for the 24V DC power supply of the binary inputs and outputs (e.g. line filter SIFI-B, Order No. B84112-B-.... from Epcos/line filter NF 1-1 from Phönix Contact). This should be located as close as possible to the terminal block. The shield connection of the line filter must be connected to ground through the shortest possible distance.

Additional an element for lightning protection/overvoltage protection should be provided for the 24V DC power supply.

For more additional information refer to Installation Manual „S7-400 and M7-400 Programmable Controllers Hardware and Installation“.

5.2 ESD guidelines

NOTE You find informations to the electrostatic sensitive modules in the reference manual "SIMATIC S7-400 Automation System Module Data, chapter 1, section: Standards, certificates and approvals".

5.3 Ambient conditions

NOTE You find information to the ambient conditions in the reference manual "SIMATIC S7-400 Automation System Module Data, chapter 1, section: Standards, certificates and approvals".

NOTE **Air intake temperature** for self- cooling
see product description of the single FM components

Index

A

Air guidance.....	5-8
Ambient conditions	5-10
Automatic mode	
Configuring the function blocks	4-91
Data transfer duration.....	4-65
Memory card	4-84
Transferring tabular values	4-64

B

BICO technology	
Changing interconnections.....	4-97
General.....	4-96
Interconnection possibilities	4-99

C

Cabinet	5-7
Cables	5-5
Configuring and parameterizing	
Basic operator actions.....	4-4
Example	4-4
HWConfig	4-3
Procedure.....	4-3
Configuring technological connectors	4-96
Configuring versions of SYNC/FREEZE	4-19
Connecting external voltages.....	5-4
Coupling to the SIMATIC S7-CPU	
Addresses	4-6
Data transfer via I/O accesses	4-9
Diagnostic interrupts.....	4-6
Initiating a process interrupt	4-8
P-bus memory	4-6
Transferring data sets	4-12

D

Danger and warning information	5-2
Definitions	
General information.....	1-1
Qualified personnel	1-1
Diagnostics function blocks	4-24
Drive coupling SIMOLINK	
configuring.....	4-44
Function blocks	4-49

Settings in HWConfig	4-44
Slave settings	4-50
E	
Equidistance and clock synchronism	4-18
Expansion module EXM 438-1	
Application	2-16
Incremental encoder settings	2-26
Load Current Power Supply	2-17
Performance features	2-17
Supplementary components	2-18
Technical data	2-28
Expansion module EXM 448	
Application	2-33
Parameterizing	2-36
Performance features	2-34
Status displays	2-37
Technical data	2-38
Expansion module EXM 448-2	
Application	2-39
Performance features	2-40
Status displays	2-42
Technical data	2-42
Expansion modules	
Installation sequence	3-2
Possibilities of combining	3-2
F	
FM 458-1 DP	
Application	2-3
Expansion modules	2-3
firmware update	2-2
operating state changes	2-13
Performance features	2-6
Status displays	2-12
Supplementary components	2-8
Technical data	2-15
Freely configuring	
Graphic configuring	4-1
Software components	4-1
Function block WR_TAB	4-59
G	
Ground connection	5-8
I	
Installation and EMC guidelines	5-1
L	
Lock the modules	3-6

M

Manual mode	
Application	4-62
Configuring	4-63
Modules FM 458-1 DP	
Application information and noise immunity	3-8
Installation sequence	3-7
Installing into the SIMATIC subrack	3-7
Mounting and operation	5-4
Mounting clearances	5-8

O

Operational reliability and noise immunity	5-3
--	-----

P

Parameter access technique for D7-SYS	4-93
Parameters configuring	4-93
Plugging the modules	3-5
Pointer-based communications blocks	
Applications	4-28
Associated function blocks	4-30
Configuring information and instructions	4-31
Examples	4-32
Features	4-29
Introduction	4-28
Pointer interface	4-31
Principal mode of operation	4-28
Potential bonding	5-6
Potential bonding rail	5-6
Power supply	5-8
product release	3-1
PROFIBUS DP	
Address connection	4-17
Configuring	4-16
Error class	4-27
SIEMENS DP-Slaves	4-25
SYNC/FREEZE	4-19
PROFIBUS DP coupling	
Central coupling block	4-16
Communications utility	4-16
Data transfer mode	4-16
Entries at address connection AT, AR	4-17
Function blocks	4-16
General basics	4-15
Protective grounding	5-7

Q

Qualified personnel	5-1
---------------------------	-----

R

Read parameters.....	4-97
Removing the connector- and socket cover.....	3-3
Removing the cover.....	3-4

S

Shielding, permissible cable lengths	5-5
SIMADYN D Components	
Technology module T400.....	4-100
Units and unit texts.....	4-102
SIMOLINK	
Features	4-37
Master slave functionality	4-39
Number of nodes on the ring.....	4-51
Status-dependent parameter changes	4-100
Subrack	5-5
SYNC/FREEZE commands.....	4-19

T

Table function	4-56
----------------------	------

W

What is EMC ?.....	5-3
--------------------	-----