



Hardware description

What this chapter contains

The chapter briefly describes the operation principle, layout, type designation label and type designation information. It also shows a general diagram of power connections and control interfaces.

Features

The MicroFlex e150 is a versatile servo drive, providing a flexible and powerful motion control solution for rotary and linear motors. Standard features include:

- Single axis drive for AC brushless servo motors. Can also control induction motors.
 - Range of models with continuous current ratings of 3 A, 6 A or 9 A.
 - Direct connection to 115 V AC or 230 V AC single-phase, or 230 V AC three-phase supplies.
 - Universal feedback interface supporting incremental encoder, BiSS, SSI, EnDat, SinCos or Smart Abs feedback.
 - Position, velocity and current control.
 - 10 optically isolated general purpose digital inputs. Two inputs have 'fast input' capability, providing real-time position capture.
 - 2 dedicated Safe Torque Off (STO) digital inputs.
 - 7 optically isolated general purpose digital outputs.
 - 2 analog inputs (± 10 V) and 1 analog output (± 10 V).
 - USB serial port (compatible with USB 2.0 and USB 3.0).
 - EtherCAT support.
 - Programmable in Mint (except models E152AxxEINA).
-

■ Operating principle

The figure below shows the simplified main circuit diagram of the drive. The rectifier converts three-phase AC voltage to DC voltage. The capacitor bank of the intermediate circuit stabilizes the DC voltage. The inverter converts the DC voltage back to AC voltage for the AC motor. The brake chopper connects the external brake resistor to the intermediate DC circuit when the voltage in the circuit exceeds its maximum limit.

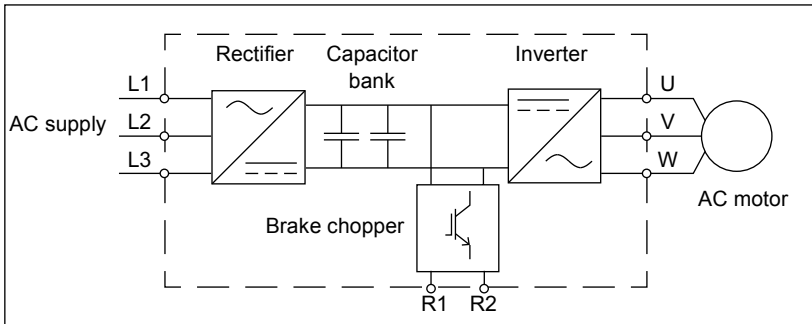

Product overview

■ Connections - front panel

X1 Power

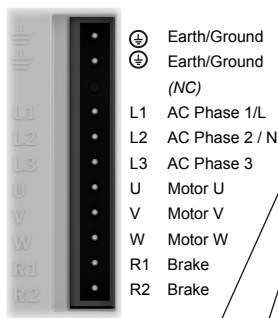

LEDs



The seven-segment display and the two EtherCAT LEDs are described in *MicroFlex e150 indicators* on page 119.

DIP switches



These switches select the Ethernet mode and RS485 settings. See *DIP switches* on page 79.

U1 USB



X6 RS485 serial port

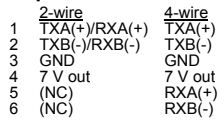
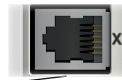
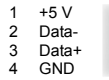

X3 Input / Output

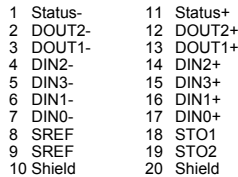
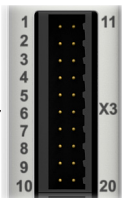

X4 Input / Output

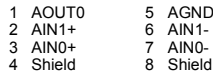

X8 Feedback in



Pin	Incremental	BiSS/SSI/ EnDat 2.2	Smart Abs	EnDat 2.1	SinCos
1	CHA+	Data+	Data+	Data+	(NC)
2	CHB+	Clock+	(NC)	Clock+	(NC)
3	CHZ+	(NC)	(NC)	(NC)	(NC)
4	(NC)	(NC)	(NC)	(NC)	(NC)
5	Hall U-	(NC)	(NC)	Sin ⁻	Sin-
6	Hall U+	(NC)	(NC)	Sin ⁺	Sin+
7	Hall V-	(NC)	(NC)	Cos ⁻	Cos-
8	Hall V+	(NC)	(NC)	Cos ⁺	Cos+
9	CHA-	Data-	Data-	Data-	(NC)
10	CHB-	Clock-	(NC)	Clock-	(NC)
11	CHZ-	(NC)	(NC)	(NC)	(NC)
12	+5 V out	+5 V out	+5 V out	+5 V out	+5 V out
13	DGND	DGND	DGND	DGND	DGND
14	Hall W-	(NC)	(NC)	(NC)	(NC)
15	Hall W+	(NC)	(NC)	(NC)	(NC)
Shell	Shield	Shield	Shield	Shield	Shield

X2 Control circuit power

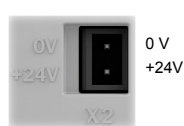

(NC) = Not Connected. Do not make a connection to this pin.

* EnDat v2.1 only. EnDat v2.2 does not use the Sin and Cos signals. Tightening torque for terminal block connections X1 & X2 is 0.5-0.6 N·m (4.4-5.3 lb-in). Maximum wire sizes: X1: 2.5 mm²; X3: 0.5 mm². Connector X3 is designed to accept bare wires only; do not use ferrules.